



Power Macintosh  
User's Guide



*Includes setup, troubleshooting, and important health-related information for Power Macintosh 9500 series computers*

 Apple Computer, Inc.

© 1996 Apple Computer, Inc. All rights reserved.

Under the copyright laws, this manual may not be copied, in whole or in part, without the written consent of Apple. Your rights to the software are governed by the accompanying software license agreement.

The Apple logo is a trademark of Apple Computer, Inc., registered in the U.S. and other countries. Use of the “keyboard” Apple logo (Option-Shift-K) for commercial purposes without the prior written consent of Apple may constitute trademark infringement and unfair competition in violation of federal and state laws.

Every effort has been made to ensure that the information in this manual is accurate. Apple is not responsible for printing or clerical errors.

Apple Computer, Inc.  
1 Infinite Loop  
Cupertino, CA 95014-2084  
(408) 996-1010

Apple, the Apple logo, AppleScript, AppleShare, AppleTalk, GeoPort, ImageWriter, Inter•Poll, LaserWriter, LocalTalk, Macintosh, MacTerminal, PlainTalk, Power Macintosh, PowerTalk, and StyleWriter are trademarks of Apple Computer, Inc., registered in the U.S. and other countries.

AppleCD, Apple Desktop Bus, At Ease, AudioVision, Balloon Help, Chicago, Disk First Aid, eWorld, Finder, Macintosh PC Exchange, and QuickDraw are trademarks of Apple Computer, Inc.

Adobe and PostScript are trademarks of Adobe Systems Incorporated or its subsidiaries and may be registered in certain jurisdictions.

Helvetica and Times are registered trademarks of Linotype-Hell AG and/or its subsidiaries.

PowerPC and the PowerPC logo are trademarks of International Business Machines Corporation, used under license therefrom.

Simultaneously published in the United States and Canada.

Mention of third-party products is for informational purposes only and constitutes neither an endorsement nor a recommendation. Apple assumes no responsibility with regard to the performance or use of these products.



# Contents



Communications regulation information vi

**Preface Welcome to Power Macintosh ix**

## Part I

### **1 Getting Started 1**

- Plugging in the computer 3
- Installing an expansion card 4
- Connecting a monitor 4
- Connecting the mouse and keyboard 8
- Connecting other equipment 10
- Turning the computer on 11
- Problems turning your computer on? 13
- What's next? 13
- Learning the basics 14
- Reviewing the basics 16
- Turning the computer off 18
- Where to find answers 19

<b>2</b>	<b>Getting Help</b>	<b>21</b>
	Getting answers to your questions	22
	Identifying objects on the screen	30
	Learning useful shortcuts	31
<b>3</b>	<b>Connecting Additional Equipment</b>	<b>33</b>
	Your computer at a glance	33
	Connecting audio equipment	36
	Connecting external SCSI devices	40
	Expanding memory	44
	Installing internal drives	44
	Connecting network cables	45
<b>4</b>	<b>Installing and Using Application Programs</b>	<b>47</b>
	Installing application programs	48
	Working with several programs at a time	49
	Backing up your files	51
	Using Power Macintosh application programs	51
<b>5</b>	<b>Using the Optional CD-ROM Player</b>	<b>53</b>
	Inserting a CD-ROM disc	54
	Ejecting a CD-ROM disc	55
	Playing audio CDs	56
	Working with Photo CDs	57
	Sharing a CD-ROM disc over a network	58

## Part II

### 6 Troubleshooting 61

- When you have questions 61
- If you have trouble 61
- Solutions to common problems 64
- Solutions to CD-ROM problems 77
- If your computer's performance decreases 84
- Solving printer problems 85
- Obtaining updated Apple software 86
- Initializing a hard disk 90
- Repairing a damaged disk 93
- Installing or reinstalling system software 97
- Installing or reinstalling CD-ROM software 107

## Part III

### Appendix A Health, Safety, and Maintenance Tips 111

- Health-related information about computer use 111
- Safety instructions 116
- Handling your computer equipment 117
- Cleaning your equipment 123
- Locking and unlocking the mouse 126

### Appendix B Installing an Expansion Card 129

- Expansion card power requirements 130
- Installing an expansion card 130
- Upgrading the processor 138

### Appendix C Special Keys on Your Keyboard 139

- Typing special characters and symbols 141
- Special key combinations 143

### Index 145

## Communications regulation information

### FCC statement

This equipment has been tested and found to comply with the limits for a Class B digital device in accordance with the specifications in Part 15 of FCC rules. See instructions if interference to radio or television reception is suspected.

### Radio and television interference

The equipment described in this manual generates, uses, and can radiate radio-frequency energy. If it is not installed and used properly—that is, in strict accordance with Apple’s instructions—it may cause interference with radio and television reception.

This equipment has been tested and found to comply with the limits for a Class B digital device in accordance with the specifications in Part 15 of FCC rules. These specifications are designed to provide reasonable protection against such interference in a residential installation. However, there is no guarantee that interference will not occur in a particular installation.

*Note:* When the 10BASE-T Ethernet is connected, the system complies only with the FCC Part 15, Class A limits and the CISPR 22, Class A limits, and may not be used in a residential area.

You can determine whether your computer system is causing interference by turning it off. If the interference stops, it was probably caused by the computer or one of the peripheral devices.

If your computer system does cause interference to radio or television reception, try to correct the interference by using one or more of the following measures:

- Turn the television or radio antenna until the interference stops.
- Move the computer to one side or the other of the television or radio.
- Move the computer farther away from the television or radio.
- Plug the computer into an outlet that is on a different circuit from the television or radio. (That is, make certain the computer and the television or radio are on circuits controlled by different circuit breakers or fuses.)

If necessary, consult an Apple-authorized service provider or Apple. See the service and support information that came with your Apple product. Or, consult an experienced radio/television technician for additional suggestions. You may find the following booklet helpful: *Interference Handbook* (stock number 004-000-00493-1). This booklet, prepared by the Federal Communications Commission, is available from the U.S. Government Printing Office, Washington, DC 20402.

**IMPORTANT** Changes or modifications to this product not authorized by Apple Computer, Inc., could void the FCC Certification and negate your authority to operate the product.

This product was tested for FCC compliance under conditions that included the use of Apple peripheral devices and Apple shielded cables and connectors between system components. It is important that you use Apple peripheral devices and shielded cables and connectors between system components to reduce the possibility of causing interference to radios, television sets, and other electronic devices. You can obtain Apple peripheral devices and the proper shielded cables and connectors through an Apple-authorized dealer. For non-Apple peripheral devices, contact the manufacturer or dealer for assistance.

## DOC statement

*DOC Class B Compliance* This digital apparatus does not exceed the Class B limits for radio noise emissions from digital apparatus as set out in the interference-causing equipment standard entitled “Digital Apparatus,” ICES-003 of the Department of Communications.

*Observation des normes—Classe B* Cet appareil numérique respecte les limites de bruits radioélectriques applicables aux appareils numériques de Classe B prescrites dans la norme sur le matériel brouilleur : “Appareils Numériques”, NMB-003 édictée par le ministre des Communications.

## VCCI statement

### 情報処理装置等電波障害自主規制について

この装置は、第二種情報装置（住宅地域又はその隣接した地域において使用されるべき情報装置）で住宅地域での電波障害防止を目的とした情報処理装置等電波障害自主規制協議会（VCCI）基準に適合しております。

しかし、本装置をラジオ、テレビジョン受信機に近接してご使用になると、受信障害の原因となることがあります。

取扱説明書に従って正しい取り扱いをしてください。

## CD-ROM drive

**WARNING** Making adjustments or performing procedures other than those specified in your equipment’s manual may result in hazardous exposure.

**WARNING** Do not attempt to disassemble the cabinet containing the laser. The laser beam used in this product is harmful to the eyes. The use of optical instruments, such as magnifying lenses, with this product increases the potential hazard to your eyes. For your safety, have this equipment serviced only by an Apple-authorized service provider.

If you have an internal Apple CD-ROM drive in your computer, your computer is a Class 1 laser product. The Class 1 label, located in a user-accessible area, indicates that the drive meets minimum safety requirements. A service warning label is located in a service-accessible area. The labels on your product may differ slightly from the ones shown here.

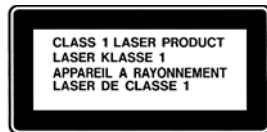

Class 1 label

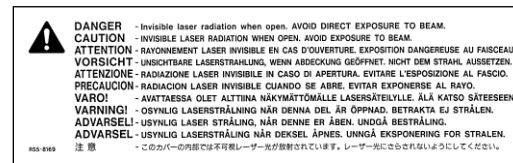

Service warning label



## Welcome to Power Macintosh



Congratulations on the purchase of your new Macintosh. Your computer is designed to give you the highest performance combined with real ease of use—it's easy to set up, easy to use, and easy to expand. This book will guide you through the setup procedure, tell you how to expand your Macintosh, and provide many tips on using your new system.

Your Macintosh computer is powered by the new **PowerPC** microprocessor (or “chip”). This microprocessor was designed by Apple Computer, Inc., Motorola, Inc., and IBM Corporation. The **PowerPC** microprocessor uses Reduced Instruction Set Computing (RISC) technology to deliver very high performance at the lowest possible cost. The **PowerPC** RISC microprocessor represents the state of the art in microprocessor design.

Your new Macintosh will run almost all your existing Macintosh software, but for best performance and greatest speed, look for the new software programs designed especially for Power Macintosh computers. You'll find Power Macintosh programs at any software store that carries products for Macintosh.

- Chapter 1**    **Getting Started**
- Chapter 2**    **Getting Help**
- Chapter 3**    **Connecting Additional Equipment**
- Chapter 4**    **Installing and Using Application Programs**
- Chapter 5**    **Using the Optional CD-ROM Player**



**I**  
*part*



Follow the instructions in this chapter to set up your computer and learn the basics.

# 1

## Getting Started



The illustration on the next page shows all the equipment you will need to set up your computer and begin using it. (Note that your monitor and keyboard may look slightly different depending on what you purchased.)

Place your equipment on a sturdy, flat surface near a grounded wall outlet. (Your computer was designed to be placed on the floor to conserve desk space, but it can also be placed on any stable, flat surface.) Before following the setup instructions in this chapter, you may want to read “Arranging Your Office” in Appendix A (in the section on health-related information) for tips on adjusting your work furniture so that you’re comfortable when using the computer.

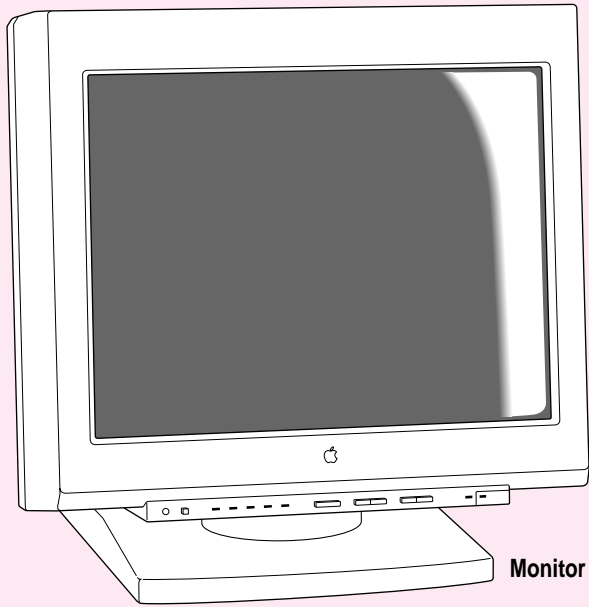

**Monitor**

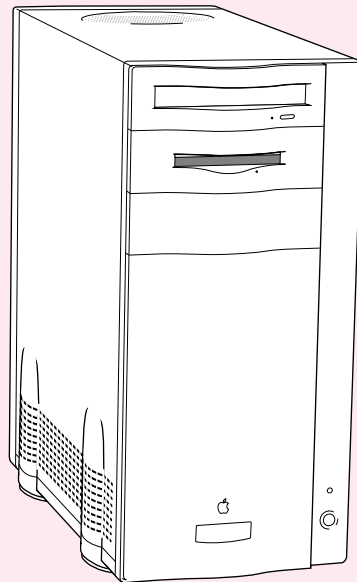

**Macintosh computer**

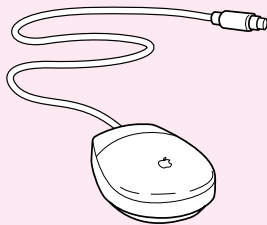

**Mouse**

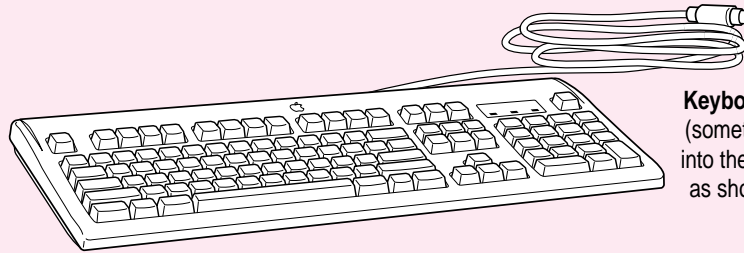

**Keyboard**

**Keyboard cable**  
(sometimes built into the keyboard as shown here)

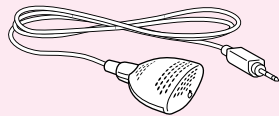

**Apple PlainTalk Microphone (optional)**

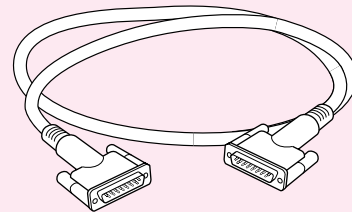

**Monitor cable**  
(sometimes built into the monitor)

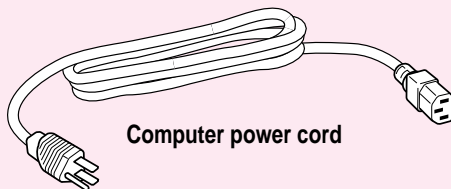

**Computer power cord**

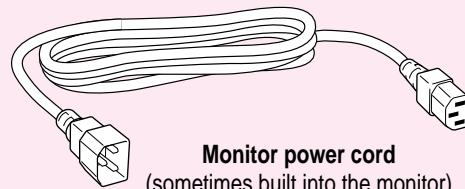

**Monitor power cord**  
(sometimes built into the monitor)

## Plugging in the computer

Before you plug your Macintosh into a wall socket, carefully read all the setup instructions in this chapter. Then, before you connect anything to your Macintosh, follow the instructions in this section to plug it in. The plug grounds the computer and protects it from electrical damage while you are setting up. When you are ready to begin, follow these steps:

- 1 **Plug the socket end of the computer's power cord into the recessed power socket (marked with the symbol ~) on the back of the computer.**
- 2 **Plug the other end of the power cord into a three-hole grounded outlet or power strip.**

**WARNING** This equipment is intended to be electrically grounded. Your Macintosh is equipped with a three-wire grounding plug—a plug that has a third (grounding) pin. This plug will fit only a grounded AC outlet. This is a safety feature. If you are unable to insert the plug into the outlet, contact a licensed electrician to replace the outlet with a properly grounded outlet. Do not defeat the purpose of the grounding plug!

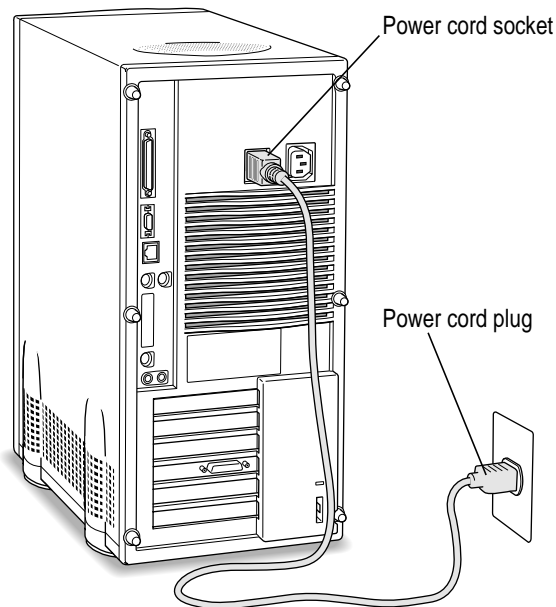

**IMPORTANT** The only way to disconnect power completely is to unplug the power cord. Make sure that at least one end of the power cord is within easy reach so that you can unplug the computer when you need to.

## Installing an expansion card

If you purchased a monitor (video) card or other expansion card for your Macintosh, install it now. (See Appendix B, “Installing an Expansion Card,” for instructions.)

*Note:* Some Power Macintosh 9500 models do not include a factory-installed monitor card, so that you can install your own monitor card. If you have one of these models, there is no monitor port on the back of the computer. You need to install your monitor card now.

If you don't have to install a monitor card or other expansion card, go on to the next section, “Connecting a Monitor.”

## Connecting a monitor

You can connect many types of monitors to your Macintosh computer, including most standard monitors. See the *Technical Information* booklet that came with your computer for a complete list.

This section contains instructions on connecting most types of monitors. Monitors from manufacturers other than Apple may require adapters for their monitor cables and power cords. If you are connecting a non-Apple monitor, also refer to the instructions that came with the monitor.

## Connecting the monitor power cord

Monitors have two cords to connect: a power cord and a monitor cable. To connect the monitor power cord, follow these steps:

### 1 Place the monitor next to the computer.

Keep these considerations in mind:

- Allow a few inches for air circulation around the computer and monitor.
- Make sure that the top of the screen is slightly below eye level when you're sitting at the keyboard.
- Position the monitor to minimize glare and reflections on the screen from overhead lights and windows.

For further suggestions about locating your computer equipment, consult “Arranging Your Office” in Appendix A (in the section on health-related information).

### 2 Connect the monitor power cord to the monitor.

On some monitors, the cord is already attached.

**3 Plug in the monitor power cord.**

Some monitor power cords are designed to plug into the back of your computer.

Some monitor power cords must be connected to a grounded electrical outlet, not to the computer. Check the information that came with the monitor.

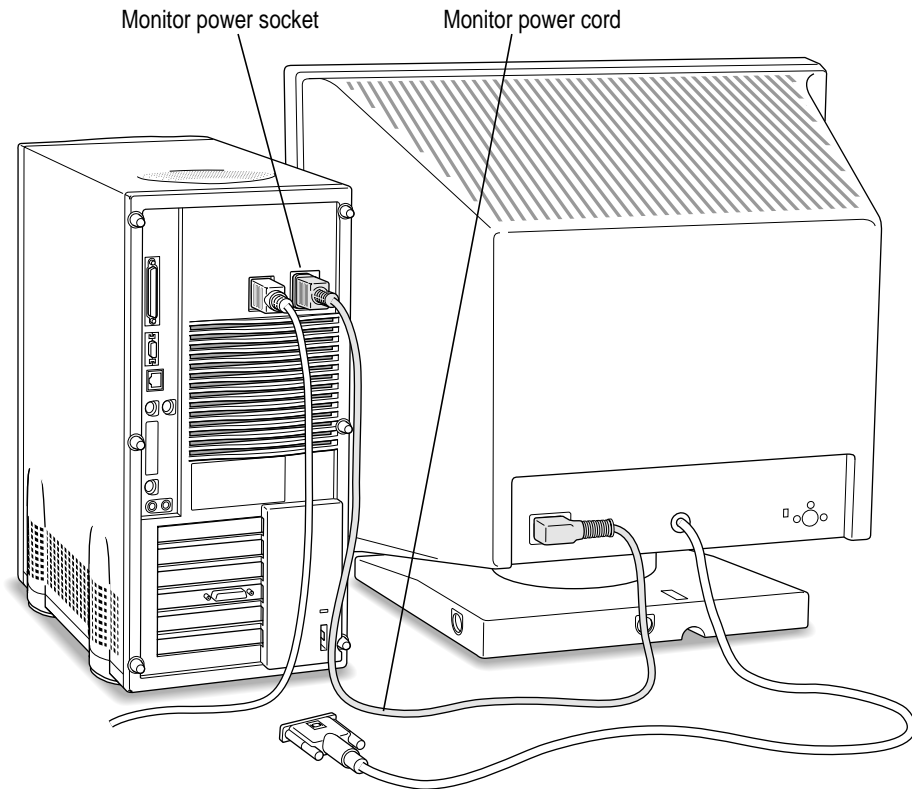

## Connecting the monitor cable

After you plug in the monitor power cord, you connect the monitor cable to the computer's monitor port.

To connect the monitor cable, follow these steps:

- 1 **Attach the monitor cable to the monitor.**

On some monitors, the cable is already attached.

- 2 **Attach the monitor cable to the monitor port at the back of the computer.**

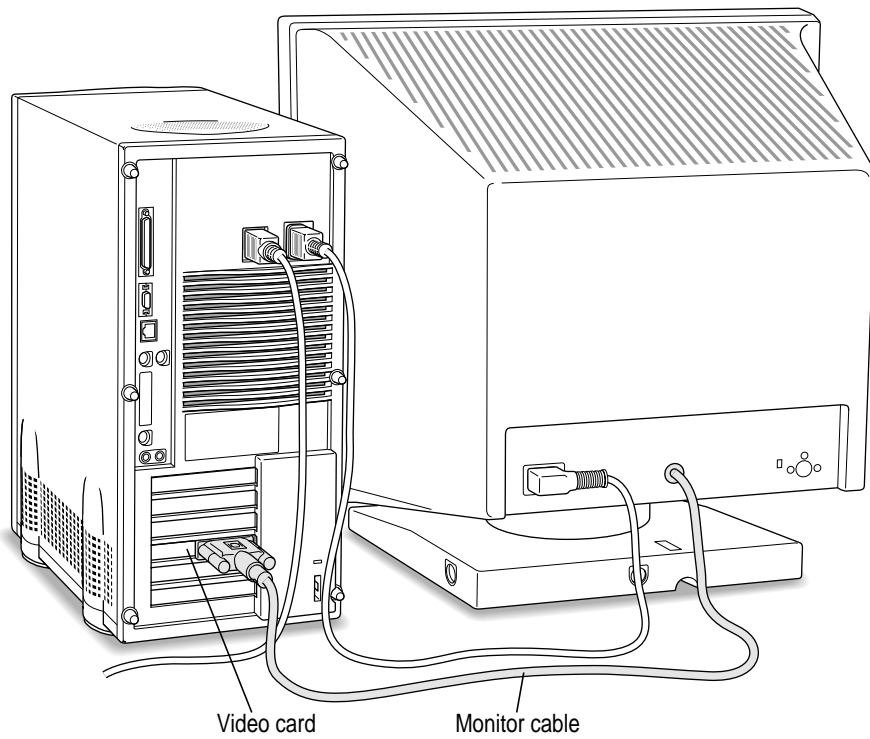



## Connecting the mouse and keyboard

You have a choice of several keyboards for your Macintosh. The way you connect the mouse and keyboard depends on whether the keyboard has a separate cable or a built-in cable.

### Connecting a keyboard with a built-in cable

- 1 Plug the mouse cable into the recessed port on the back of the keyboard.**

The plug and the port are marked with the  icon (symbol). The positions of the port and icon on your keyboard may be different from those pictured.

*By the way:* A port marked with the  icon is called an Apple Desktop Bus (ADB) port.

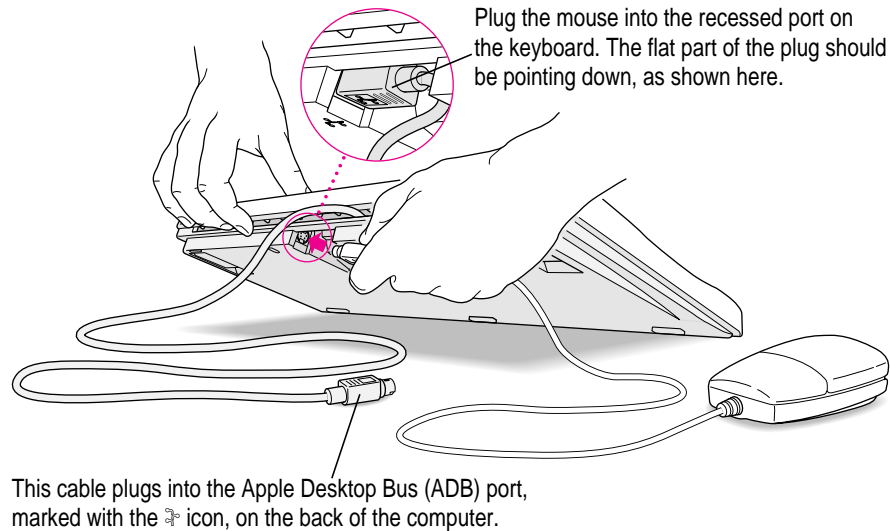

- 2 Plug the keyboard cable into the port marked with the  icon on the back of the computer.**

Some monitors have a port to which you can connect the keyboard or mouse. See the information that came with your monitor.

## Connecting a keyboard with a separate cable

- 1 Plug the mouse cable into the port on either side of the keyboard.**

Most right-handed people prefer to use the mouse with their right hand; most left-handed people prefer to use their left hand. Plug the mouse into the port on the side you prefer.

The plug and the port are marked with the  icon (symbol). Align the symbols before you insert the plug. (The positions of the port and icon on your keyboard may be different from those pictured here.)

*By the way:* A port marked with the  icon is called an Apple Desktop Bus (ADB) port.

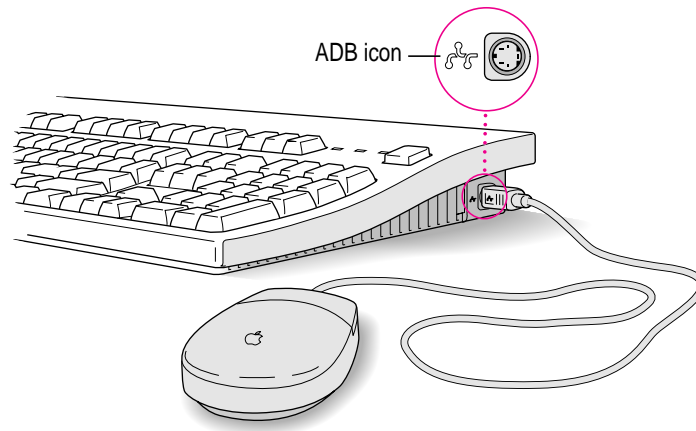

- 2 Plug the keyboard cable (both ends are the same) into the other port on the keyboard.**

If you plugged the mouse cable in on the right, for example, plug the keyboard cable in on the left.

- 3 Plug the keyboard cable into the port marked with the  icon on the back of the computer.**

Some monitors have a port to which you can connect the keyboard or mouse. See the information that came with your monitor.

## Connecting other equipment

If you are new to the Macintosh, it's a good idea to get some experience using your computer before you connect other equipment, such as a printer or scanner. To learn basic Macintosh skills, continue with the instructions in this chapter.

When you're ready to connect other equipment to your Macintosh, see the instructions in Chapter 3.



## Turning the computer on

To turn on the computer for the first time, follow these steps:

- 1 **Turn on your computer by pressing the Power key on the keyboard.**

The Power key is marked with a triangle. Its location depends on which keyboard you have.

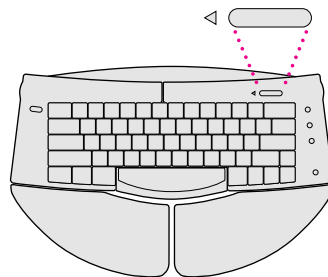
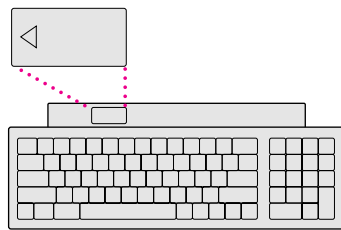
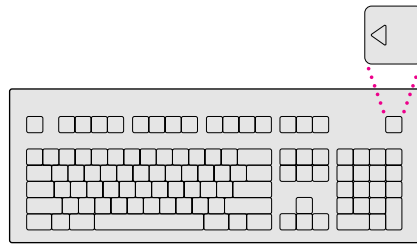

You hear a tone from the computer as it starts up.

## 2 Turn on your monitor.

See the information that came with your monitor for the location of the power switch. On Apple monitors, the power switch is located on the front of the unit.

*By the way:* You only need to turn on the monitor once. From now on, the monitor will turn off automatically when you shut down the computer, and it will turn on automatically when you start up the computer. (If the monitor is not plugged into the computer, it must be turned on separately each time you turn on the computer.) If you have extra DRAM installed in your computer, it can take several seconds for larger monitors to turn on. (The screen remains black.)

## 3 Check to see what's on your screen.

- If you see a message about saving energy, read the information and click “Close Message.”
- If you see the Macintosh desktop, shown here, your system software is already set up correctly. Skip now to “What's Next?”

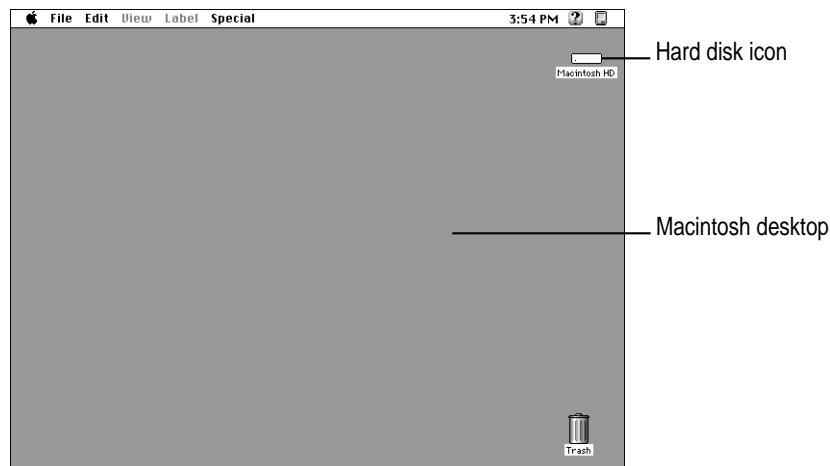

- If you see a blinking question mark, see “Solutions to Common Problems” in Chapter 6.
- If you see anything else on your screen, or if you see nothing at all, see the next section, “Problems Turning Your Computer On?”

## Problems turning your computer on?

If you don't see anything on the screen, check these items to see if you can identify the problem:

- Is the computer plugged into a power source? If it is plugged into a power strip, is the power strip turned on?
- Is the computer turned on? The power-on light on the front panel should be on. If it isn't on, press the power button (marked with the symbol Ⓞ).
- Are the keyboard and mouse cables connected correctly? (Don't connect or disconnect the keyboard or mouse cable while the computer is on. You could damage your equipment.)
- Is the monitor power cord plugged in?
- Is the monitor turned on? (Check the power-on light on the front of the monitor.)
- Is the monitor cable attached firmly to both the monitor and computer?
- Is the brightness control on the monitor adjusted correctly? (On most monitors, the brightness control is marked with the symbol ☼.)

## What's next?

You've finished setting up your computer. Continue with one of the following steps:

- If you are new to the Macintosh, turn to the next section, "Learning the Basics."
- If you are an experienced Macintosh user, turn to Chapter 2, "Getting Help," to learn about Macintosh Guide, your main source of information when you're working with the Macintosh.
- If you want to connect additional equipment, such as a microphone, to your computer, see Chapter 3 of this book for instructions.
- If you want to install application software on your computer, see Chapter 4 of this book for information on setting up your programs and managing memory. You'll need this information to properly set up any software programs specifically designed for Power Macintosh computers.

**IMPORTANT** If you need to turn off your computer at any point, please see "Turning the Computer Off" later in this chapter. It is very important to use the correct procedure for shutting down your Macintosh before turning it off.

## Learning the basics

If you are new to the Macintosh, you should begin by looking at the easy-to-use program called the Macintosh Tutorial. The tutorial teaches you the basic skills you'll need to use your computer. To start the tutorial, follow these steps:

### 1 Slide your mouse along your mouse pad or desk.

Hold the mouse as shown, with the cable pointing away from you. Rest the heel of your palm on the desk and grasp the sides of the mouse between your thumb and fingers. Use your wrist and fingers to slide the mouse around with the index finger resting on the mouse button. Don't press the mouse button (under your index finger). Notice that the arrow (␣) on the screen moves in the same direction that you move the mouse.

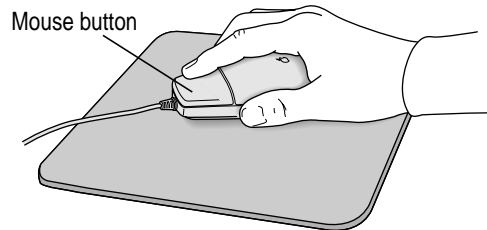

If the arrow doesn't move, make sure that the cables connecting the mouse and keyboard are secure and that your mouse is positioned as shown in the illustration.

- 2 **Move the tip of the arrow (⏏) to the question mark (?) in the upper-right portion of the screen.**

If you run out of room on your mouse pad or desk while moving the mouse, pick up the mouse and place it where there's more room. (The arrow on the screen moves only when the mouse is in contact with the mouse pad or desk.)

- 3 **With the tip of the arrow on the question mark, press and hold down the mouse button.**

A list of choices (called a *menu*) appears. This is the Guide (?) menu, which is the place to go when you have a question about how to use your computer.

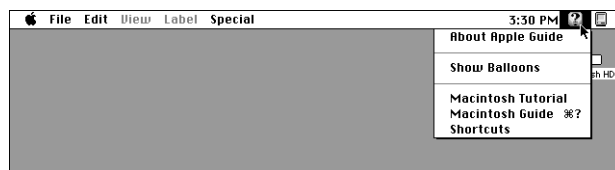

- 4 **While holding down the mouse button, move the arrow until the words "Macintosh Tutorial" are highlighted, then release the mouse button.**

A window appears welcoming you to the tutorial. You can set this book aside for now and follow the instructions on the screen. When you have completed the tutorial, return to this book.

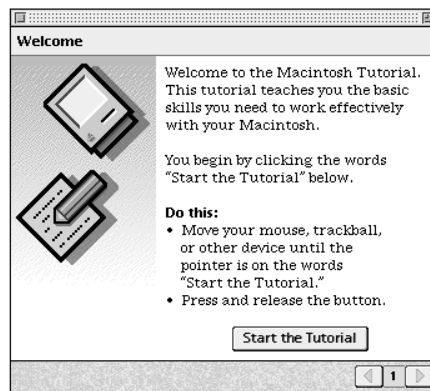

## Reviewing the basics

You can use the following illustrations to review the elements you use on your screen to do work with your computer.

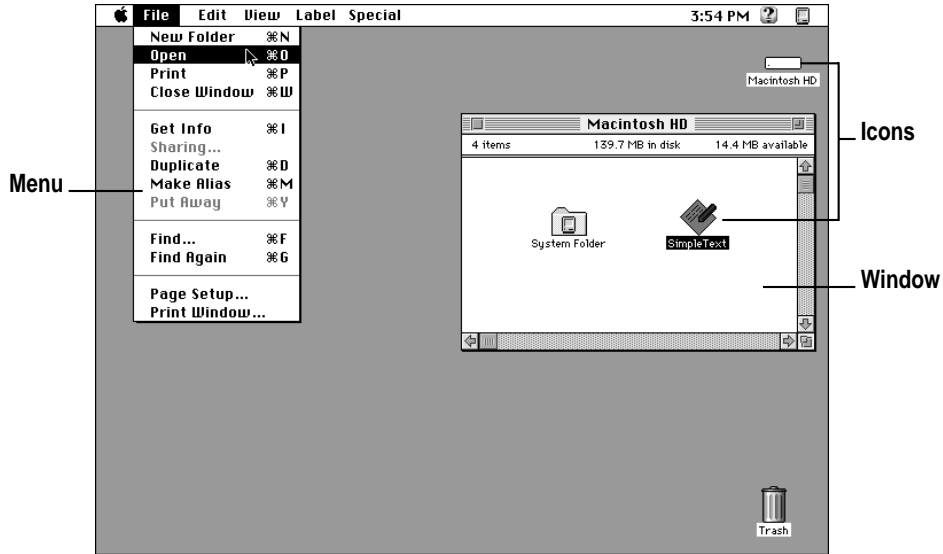

## Menus

The strip across the top of the screen is called the menu bar. The symbols and words in it represent menus of commands. To open a menu, place the pointer on the symbol or word for the menu and press the mouse button.

### Guide menu

To find an answer to a question, look in the Guide (G) menu.

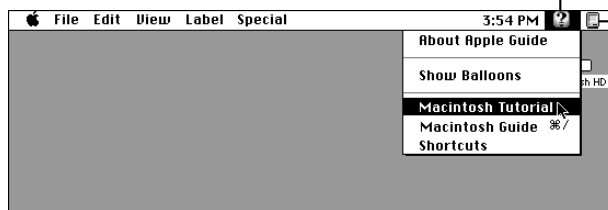

### Application menu

You can have several application programs open at once. To see which program is active or to switch from one program to another, use this menu (called the Application menu).

## Icons

Icons are small pictures that represent disks, programs, documents, and folders. You can double-click any icon to open it and see what it contains.

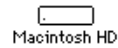

This icon represents your computer's internal hard disk.



Application

Icons like this one represent application programs, which you use to create documents and do other work.



Document

Icons like this one represent documents, which you can create and edit.



Folder

Icons like this represent folders. A folder contains other icons.



Trash

To throw away an item you no longer want, drag it to the Trash icon and choose Empty Trash from the Special menu.

## Windows

Windows are boxes that display text, graphics, or icons. To change the shape or position of a window, or to close the window, use the elements shown here.

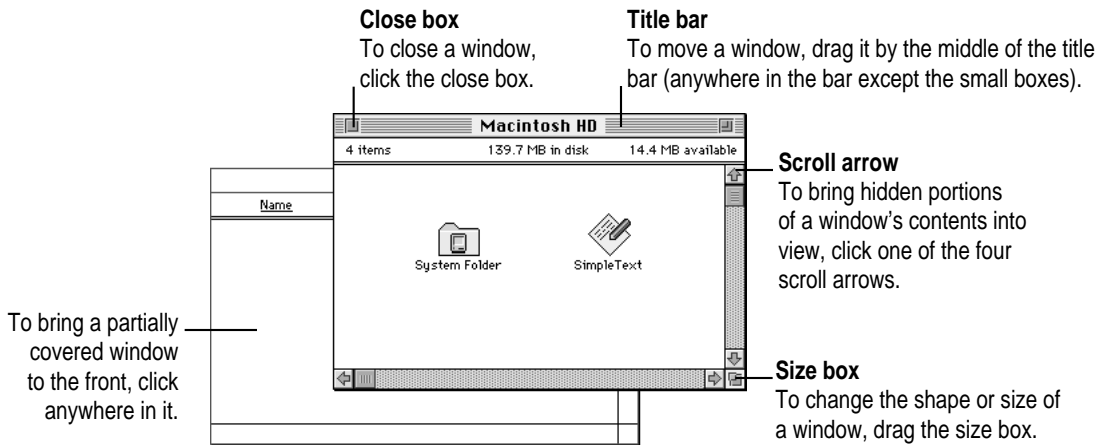

## Turning the computer off

To turn your computer off, you choose Shut Down from the Special menu. Detailed instructions follow.

- 1 Move the tip of the arrow (⬆) to the word “Special” at the top center of the screen.



If the word “Special” does not appear at the top of the screen, you’re working in the wrong program. Pull down the Application menu (to the right of the Guide [?] menu) and choose Finder. Then try step 1 again.

- 2 With the tip of the arrow on the word “Special,” press and hold down the mouse button.
- 3 While holding down the mouse button, move the arrow down until the words “Shut Down” are highlighted, then release the mouse button.



Choosing Shut Down readies the hard disk for a fast restart next time you turn on the computer. It also prompts you to save any unsaved work on a disk before turning the power off.

To turn the computer on again, just press the Power key on the keyboard.

**IMPORTANT** The power button on the front of the computer should not be used to turn off your computer unless there is a problem that prevents it from being turned off with the Shut Down command. (You could lose unsaved work.) To make sure your work is saved, use the Shut Down command.

## Where to find answers

When you have questions about using your Macintosh, there are several places you can look for answers.

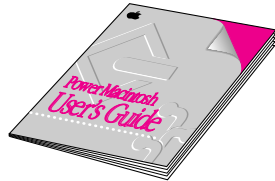

### In this book

Use this book to help you set up your computer and learn about it, or to find solutions to problems with your equipment.



### In the Guide menu

The Guide menu (marked with the  icon) is your main source of information about the Macintosh. To learn how to get different kinds of help from the Guide menu, see Chapter 2 in this book.

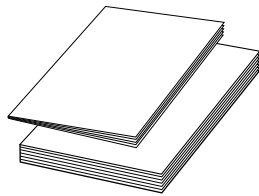

### In other manuals

For answers to questions about other equipment or about application programs you have purchased, see the manuals that came with the equipment or programs.



About Apple Extras

### In documents in the Apple Extras folder

The Apple Extras folder on your hard disk contains a SimpleText document called About Apple Extras (often called a "Read Me" file) with important information about some of the application programs included with your computer. Read Me files can also be found inside application folders.



### From Apple's customer support hotline

If you can't find an answer in any of the materials provided, call the customer support hotline. (The phone number for the hotline is in the service and support information that came with your computer.)

If you have problems with a particular application program, contact the manufacturer of the program.



Use the instructions in this chapter to learn about the help available to you in the Guide menu.

## 2 Getting Help

The Guide menu is your main source of information when you're working with your computer. The menu is identified by a question mark (🔍) in the upper-right corner of the screen.



## Getting answers to your questions

When you have a question while working with your computer, you can get the answer by choosing Macintosh Guide from the Guide menu.

- 1 Pull down the Application menu (in the upper-right corner of the screen) and choose Finder to make it the active application program.



A checkmark in the menu indicates that the Finder is the active program.

- 2 Pull down the Guide menu (marked with the ? icon) and choose Macintosh Guide.



The Macintosh Guide window appears.

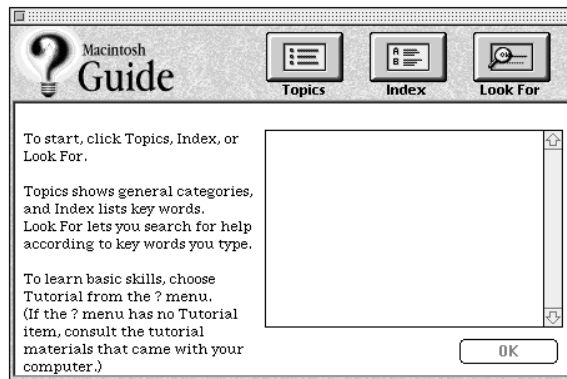

Whenever you use Macintosh Guide, its window remains in front of other windows. If the window gets in your way, you can move it by dragging its title bar (the gray bar across the top of the window).

- 3 Notice the three buttons at the top of the window: **Topics**, **Index**, and **Look For**.



Macintosh Guide gives you three ways of finding information:

- **Topics** lets you choose from a list of general subjects; it is like the table of contents in a book.
- **Index** lets you choose from an alphabetical list of more specific subjects; it is like the index in a book.
- **Look For** lets you search for information related to a specific word or phrase that you type.

In the following sections you will practice using each method.

If you have problems while using Macintosh Guide, see “Tips for Using Macintosh Guide” at the end of this section.

### Getting answers with the Topics button

- 1 In the Macintosh Guide window, click the **Topics** button.

A list of general topics appears on the left side of the Macintosh Guide window. (Depending on the hardware and software you have, the list of topics may look different.)

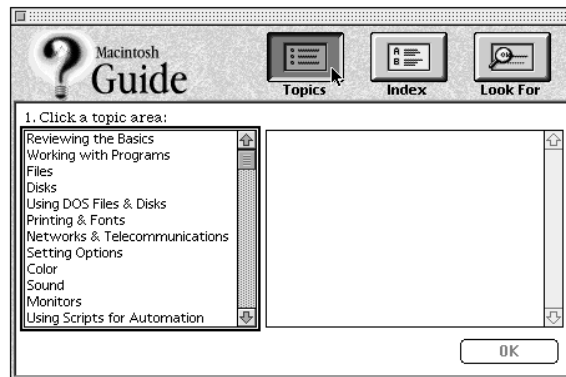

- 2 Click “Customizing Your Computer” or “Setting Options” (whichever is available) in the list of topics.

When you click any topic area, a list of related questions appears on the right side of the Macintosh Guide window.

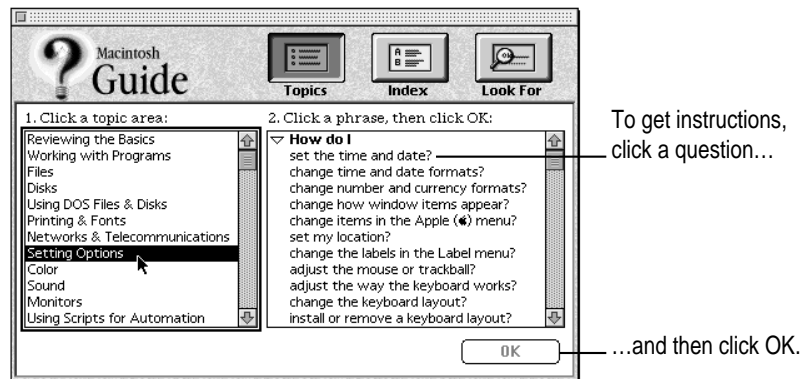

- 3 Click the question “How do I set the time and date?” and then click OK. Or double-click the question.

A small window appears with instructions for you to follow.

If you want to return to the main Macintosh Guide window, click this Topics button. (On some computers, it says “Topics.”)

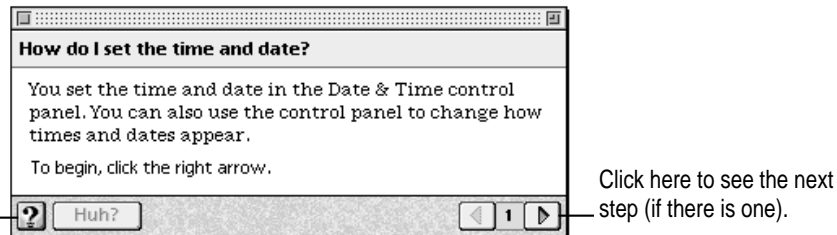

- 4 Read and follow the instructions in this window.

Macintosh Guide provides step-by-step instructions to answer the question you selected. When you have completed each step, click the right arrow in the lower-right corner to see the next step.

- 5 When you have completed all the steps, click the Topics (or ?) button in the lower-left corner to return to the main Macintosh Guide window.

Now continue with the next section.

## Getting answers with the Index button

- 1 In the Macintosh Guide window, click the Index button.

An alphabetical list of subjects appears on the left side of the window.

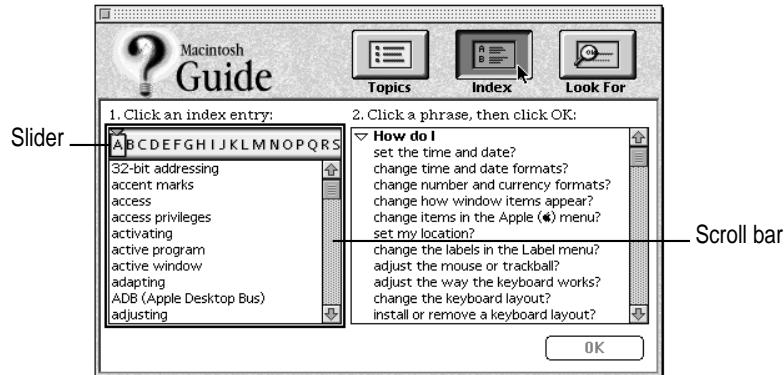

- 2 Scroll through the alphabetical list until the phrase “background pattern” is visible.

You can scroll through the list either by dragging the slider to the letter *B* or by using the scroll bar at the right of the list.

- 3 Click the phrase “background pattern” in the alphabetical list.

When you click any index entry, a list of related questions appears on the right side of the Macintosh Guide window.

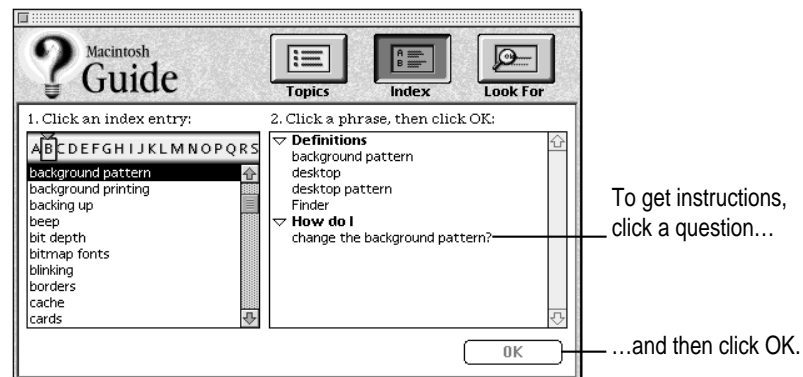

- 4 Click the question “How do I change the background pattern?” and then click OK. Or double-click the question.

A small window appears with instructions for you to follow.

If you want to return to the main Macintosh Guide window, click this Topics button. (On some computers, it says “Topics.”)

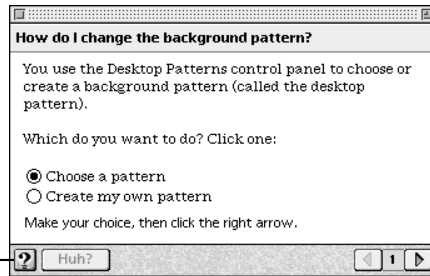

Click here to see the next step (if there is one).

- 5 Read and follow the instructions in the window.

Macintosh Guide provides step-by-step instructions to answer the question you selected. When you have completed each step, click the right arrow in the lower-right corner to see the next step.

- 6 When you have completed all the steps, click the Topics (or ) button in the lower-left corner to return to the main Macintosh Guide window.

Now continue with the next section.

## Getting answers with the Look For button

- 1 In the Macintosh Guide window, click the Look For button.

A small box appears on the left side of the window, where you can type text.

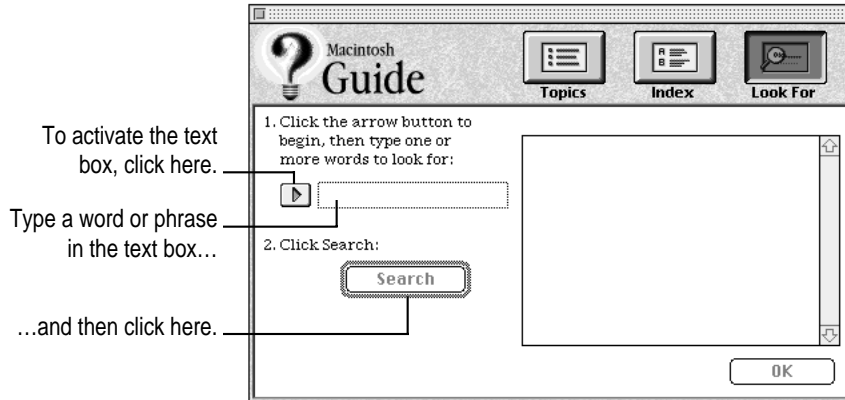

- 2 Click the arrow button to activate the text box.
- 3 Type "trash" in the text box and then click Search.

When you click Search, a list of questions related to the word or phrase you typed appears on the right side of the Macintosh Guide window.

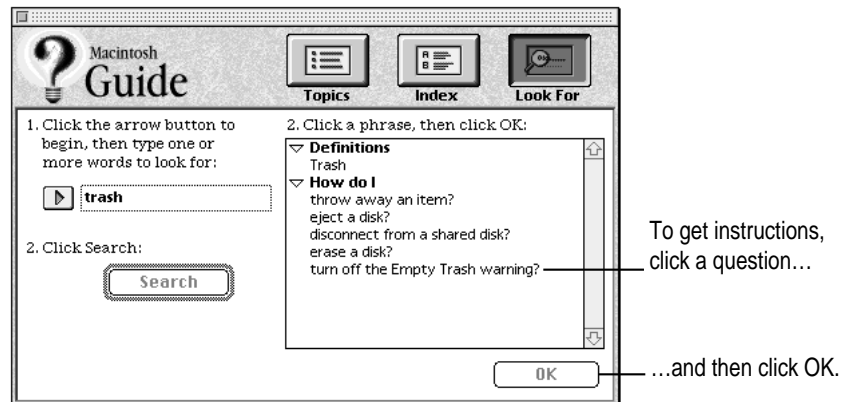

- 4 Click the question “How do I turn off the Empty Trash warning?” and then click OK. Or double-click the question.

A small window appears with instructions for you to follow.

If you want to close  
Macintosh Guide,  
click here.

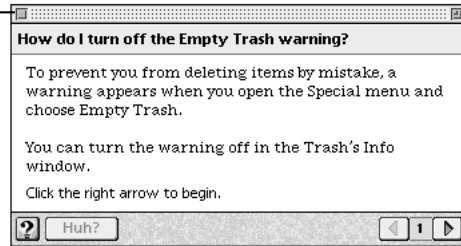

Click here to see the next  
step (if there is one).

- 5 Read and follow the instructions in the window.

Macintosh Guide provides step-by-step instructions to answer the question you selected. When you have completed each step, click the right arrow in the lower-right corner to display the next step.

- 6 When you have completed all the steps, click the close box in the upper-left corner to close Macintosh Guide.

## Tips for using Macintosh Guide

Here are a few tips for using Macintosh Guide effectively:

- Macintosh Guide is available only when you are in the Finder—the desktop area where you can see the icons of disks, folders, and files. (Other programs may also have help available in the Guide menu, however.) If you don't see Macintosh Guide in the Guide menu, pull down the Application menu (to the right of the Guide menu) and choose Finder.
- Follow the steps when you're instructed to; don't skip ahead or read ahead. That way the computer can check to make sure you've done a step correctly.
- Unlike most windows, the Macintosh Guide window stays in front of other windows on the screen so that your instructions are never covered. If you need to move the Guide window out of the way, drag it by the title bar at the top of the window.

You can also move the window out of the way by clicking the zoom box. Click the box once to shrink the window; click it a second time to expand the window to its original size.

- If you need more information about an instruction or a term, click the button labeled “Huh?” to get further explanation. (The “Huh?” button is dimmed when no additional information is available.)
- If you want to return to the main Macintosh Guide window, click the Topics button in the lower-left corner of the Guide window.
- When you're finished using Macintosh Guide, click the close box in the upper-left corner of the window.

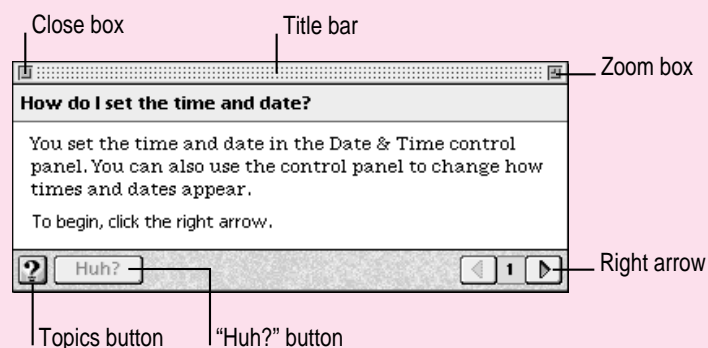

## Identifying objects on the screen

Sometimes you'll see an unfamiliar item on the screen and ask yourself, "What's that?" You can get an answer by using a Macintosh feature known as Balloon Help.

Balloon Help explains the function of icons, menus, commands, and other items on the Macintosh screen in balloons like those you see in comic strips.

Follow these steps to use Balloon Help:

- 1 Pull down the Guide menu (marked with the ) and choose Show Balloons.



- 2 Point to any object on the screen that you want to identify.

A balloon appears next to the object. In the following illustration, for example, pointing to the Trash displays a balloon that explains how to use the Trash to throw items away.



Although balloons appear next to items when you point to them, the way you work does not change; you can still select icons, choose commands, and so on.

- 3 When you're finished using Balloon Help, choose Hide Balloons from the Guide menu.

## Learning useful shortcuts

You can perform many tasks in the Finder more quickly if you use keyboard or mouse shortcuts. For example, instead of clicking an icon and choosing Open from the File menu, you can simply double-click the icon to open it.

Follow these steps to learn keyboard and mouse shortcuts:

- 1 **Pull down the Guide menu (marked with the  icon) and choose Shortcuts.**

The main Macintosh Shortcuts window appears.

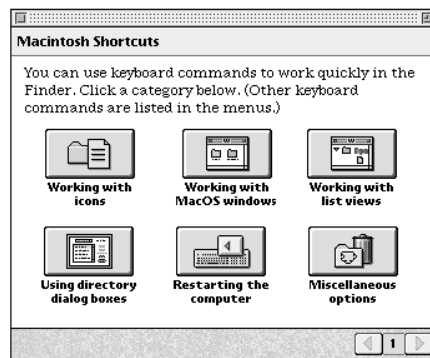

- 2 **Click one of the category buttons.**

Another window appears, describing shortcuts for that category.

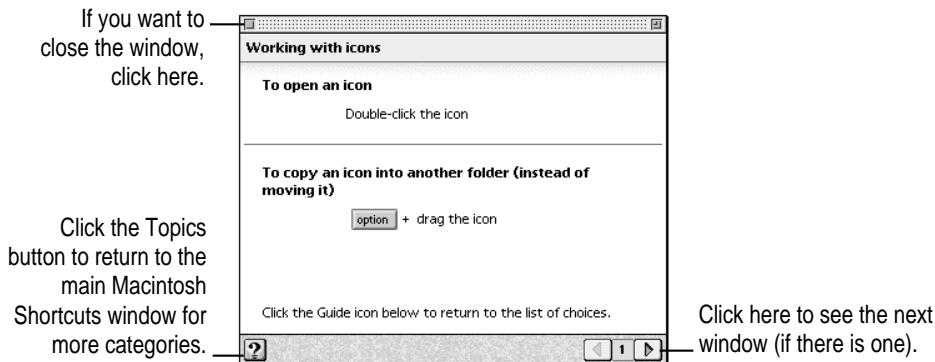

**3 Read about the shortcuts available for the category you selected.**

Click the right arrow in the lower-right corner of the window to display the next window (if there is one).

**4 When you finish reading about the shortcuts for your category, click the Topics button in the lower-left corner to return to the main Macintosh Shortcuts window. Or click the close box in the upper-left corner to close the window.**

Read this chapter for information on expanding your computer system with additional hardware.

# 3

## Connecting Additional Equipment



### Your computer at a glance

The illustration on the next page shows a basic Power Macintosh 9500 system, ready to use. (Remember that your monitor and keyboard may appear slightly different from the ones pictured here, depending on what you purchased.)





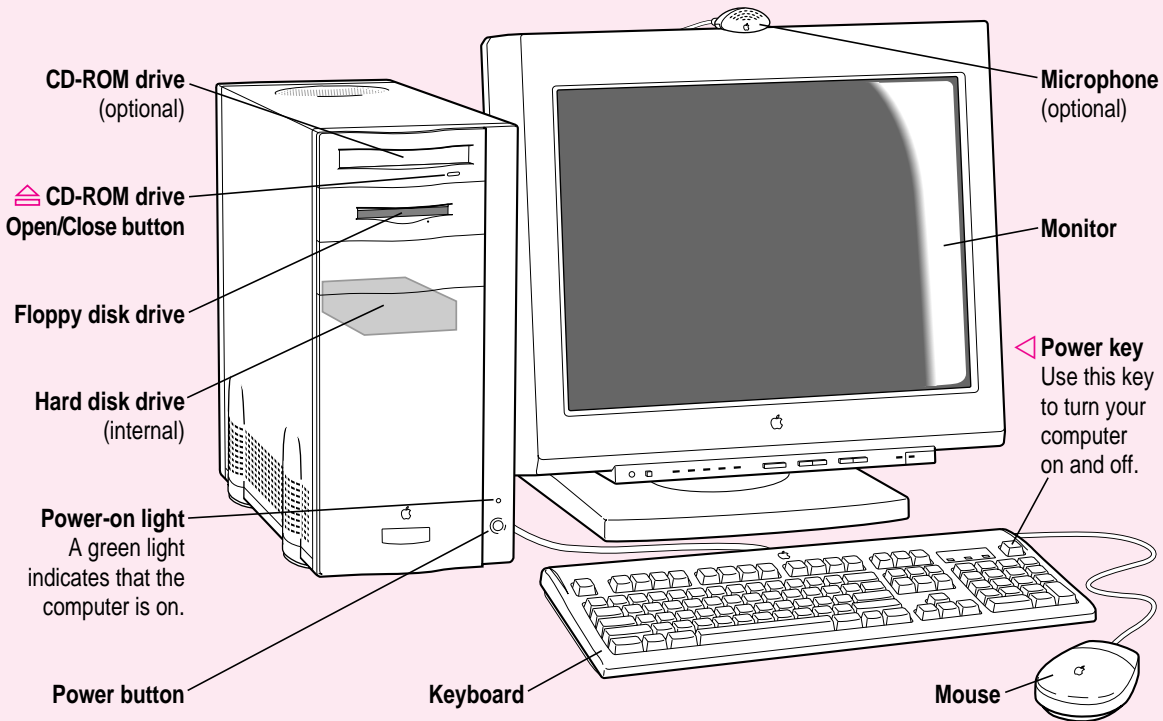

You can also expand your computer system by connecting other equipment to it. The illustration on the facing page shows where equipment should be connected to your Macintosh.

For instructions on connecting audio equipment or SCSI devices, refer to the next two sections of this chapter. For instructions on connecting other equipment, such as a CD-ROM player (also called a CD-ROM drive), see the manual that came with the equipment.

**IMPORTANT** Make sure each device you add is compatible with your computer and does not exceed the maximum power allowance for that device. If it is a SCSI or ADB device, make sure to turn off your computer before connecting the device. For further information, consult your Apple-authorized dealer, the manufacturer of the component you want to add, or the *Technical Information* booklet that came with your computer.



### Your computer's ports and connectors

<b>SCSI port</b>		Connects your Macintosh to SCSI equipment such as external hard disk drives and scanners.
<b>Ethernet port (AAUI)</b>		Connects your Macintosh to a high-speed Ethernet network using an adapter.
<b>Ethernet port (10BASE-T)</b>		Connects your Macintosh to a high-speed 10BASE-T Ethernet network.
<b>Modem port (GeoPort)</b>		Connects an external modem or GeoPort Adapter to your Macintosh.
<b>Printer port (GeoPort)</b>		Connects your Macintosh to a printer, LocalTalk network, or GeoPort Adapter.
<b>Monitor port</b>		Connects a monitor to a monitor (video) card.

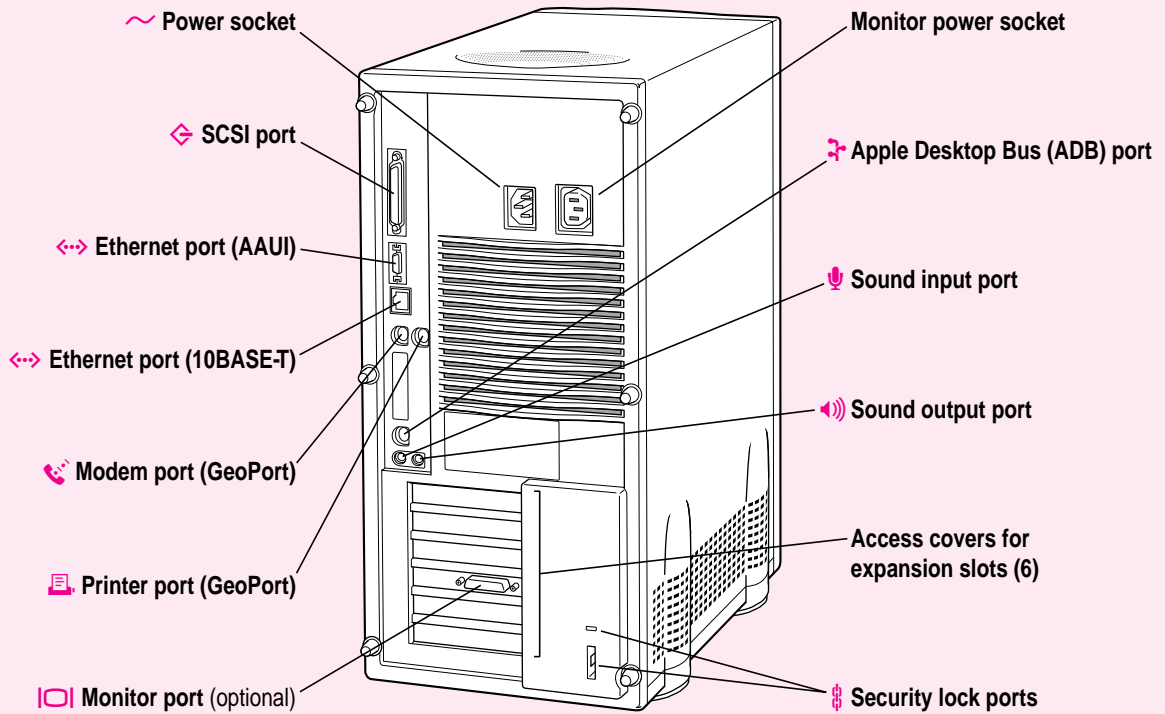

**Apple Desktop Bus (ADB) port**

 Connects your Macintosh to an input device, such as a keyboard or a trackball.

**Sound input port**

 Connects your Macintosh to an Apple PlainTalk Microphone or other audio input equipment.

**Sound output port**

 Connects your Macintosh to headphones, externally powered (amplified) speakers, or other audio output equipment.

**Access covers for expansion slots (6)**

Your Macintosh supports up to six Peripheral Component Interconnect (PCI) cards.

**Security lock ports**

 You can attach a security lock to your Macintosh. See your computer products retailer for security lock devices that work with your computer.

## Connecting audio equipment

Your Macintosh can play and record stereo sound from a variety of sources. You can listen to or reproduce stereo sound by connecting audio equipment to the sound input and output ports on the computer. If you have an internal CD-ROM player, you can also use your computer to play and record sound from audio compact discs (CDs).

For information on using Macintosh system software to choose audio input and output options, record an alert sound, or play audio CDs, see the “Sound” topic of Macintosh Guide, available in the Guide (📖) menu.

### About your computer's sound ports

The sound input port is marked with an icon of a microphone. The sound output port is marked with an icon of a speaker.

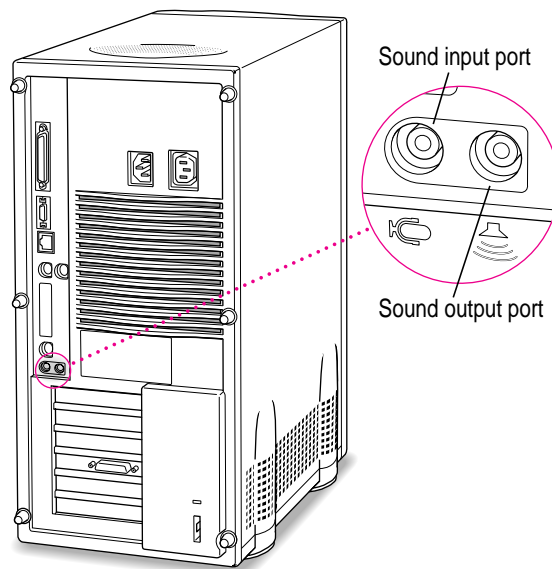

The computer's sound ports accept these 3.5 mm audio connectors:



Stereo miniplug

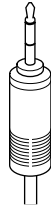

Extended miniplug

The stereo miniplug is found most often on stereo equipment (for example, personal headphones). The extended miniplug is slightly longer and is found on voice-quality microphones (for example, the Apple PlainTalk Microphone). If your equipment has a different type of connector, you can purchase an adapter at an electronics supply store.

### Connecting audio equipment

To play or record sound with your Macintosh, you can attach a microphone, amplifier, tape recorder, or a pair of speakers.

For specific instructions on connecting a microphone, skip to the next section, “Connecting and Positioning a Microphone.” For specific instructions on connecting speakers, see “Connecting External Stereo Speakers,” later in this section.

Follow these steps to connect audio equipment to the Macintosh:

- 1 Make sure that the audio equipment has a cable with a stereo miniplug connector.**

If it does not, attach an adapter that has a stereo miniplug.

- 2 Place the audio equipment near the Macintosh.**
- 3 Shut down the Macintosh and turn off the audio equipment.**
- 4 Attach the cable to the audio equipment and to the appropriate sound port on the Macintosh.**

To record incoming sound on the computer, connect the audio equipment to the sound input port (Ⓜ).

To record the sound produced by the computer or play that sound through external speakers, connect the audio equipment to the sound output port (Ⓜ).

- 5 Turn on the computer and the audio equipment.**

You're now ready to begin listening to and working with sound. For more information on working with sound, see the “Sound” topic of Macintosh Guide, available in the Guide (⌘) menu.

## Connecting and positioning a microphone

With appropriate software, you can use the Apple PlainTalk Microphone that comes with some Macintosh computers (or a compatible line-level microphone) to record your voice or other sounds.

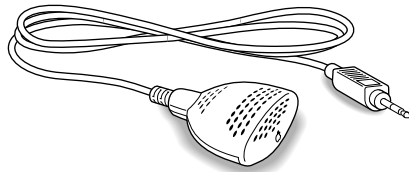

Apple PlainTalk Microphone

You can't use the round, omnidirectional microphone supplied with some other Macintosh models.

Follow these steps to connect and position the microphone:

- 1 Shut down the Macintosh.**
- 2 Plug the microphone's connector into the sound input port (🔊) on the back of the computer.**
- 3 Place the microphone at the top center of the monitor, so that the microphone's Apple (🍏) icon is facing you.**

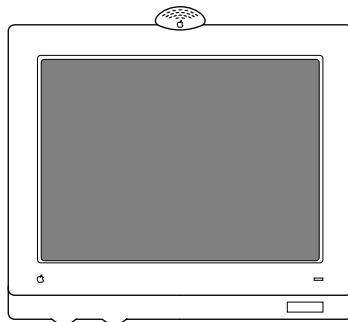

If you can't place the microphone on top of the monitor, position the microphone according to these guidelines:

- The microphone should be between 1 and 3 feet away from you.
- The microphone should be directly in front of you to minimize the effect of background noises.

**4 Turn on the computer.**

You're now ready to begin using your microphone.

### Connecting external stereo speakers

You can take advantage of your computer's stereo sound output by attaching externally powered (amplified) speakers.

**1 Assemble the speakers and the cable you need.**

You need a cable with a stereo miniplug at one end to connect one or both speakers to the computer. (Some speakers require a dual-plug adapter. Others, like those shown in the next illustration, accept a single stereo miniplug and are joined by standard speaker wires.) See the documentation that came with your speakers for more information.

**2 Turn off the Macintosh.**

**3 Plug a stereo miniplug into the sound output port (🔊) on the Macintosh.**

**4 Connect the speakers together with speaker wires, if necessary.**

Your finished connections should look something like this:

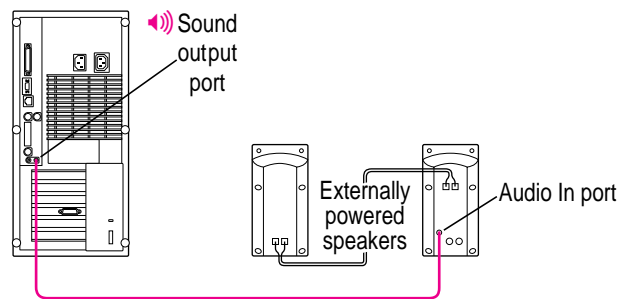

## 5 Turn on the computer.

Now you hear the computer's sound through the external speakers.

*Note:* To control the volume of your external speakers, open the Sound control panel and choose Volumes in the pop-up menu. Use the Built-in Headphones slider to adjust the volume for your external speakers. If you are playing an audio CD, you may also need to adjust the volume control in the program you're using to play CDs.

## Connecting external SCSI devices

Your computer has a port for connecting devices that use the Small Computer System Interface (SCSI, pronounced "skuh-zee"). The SCSI port permits high-speed communication between the computer and the device. The SCSI icon appears above the port on the computer's back panel.

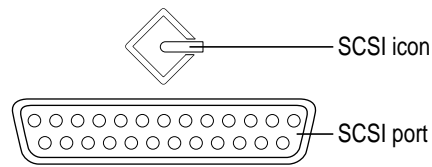

You can connect SCSI devices to the SCSI port in a chain. The first device in the chain plugs into the SCSI port; the second device plugs into the first device, and so on. SCSI devices commonly used with the Macintosh include hard disk drives, CD-ROM players, scanners, printers, and tape or cartridge backup drives. You can attach up to seven SCSI devices to the external SCSI port of your computer.

*Note:* In addition to the external SCSI port, your computer has a second, internal SCSI interface. The internal hard disk drive that came with the computer and the optional CD-ROM player are connected to this internal SCSI interface. You can have an Apple-authorized dealer attach an additional device to the internal SCSI interface. For more information about the SCSI interfaces, see the *Technical Information* booklet that came with your computer.

**IMPORTANT** “Before You Connect a Device” and “Connecting a SCSI Device” contain general instructions for attaching SCSI devices to your computer. Be sure also to follow the specific instructions that came with your external hard disk drive or other SCSI device when connecting the device to your Macintosh.

### Before you connect a device

Before you connect a SCSI device to your Macintosh, be sure to complete these tasks:

- Install any necessary device drivers (software that makes a device work with your computer). Drivers needed for a SCSI device usually come on a floppy disk with the device. (If no drivers come with the device, then the device doesn't need drivers.) Be sure the drivers are designed for Power Macintosh.
- Make sure each SCSI device connected to your Macintosh has its own, unique ID number from 0 to 6 (or from 1 to 6 if you have a second internal hard disk installed). See the instructions that came with each SCSI device for information on checking and setting its SCSI ID number.

**IMPORTANT** If you use two or more devices with the same ID number, your equipment could malfunction and you could lose data as a result.

- Make sure you have the appropriate cable for attaching the SCSI device to your Macintosh.

If the device is the first or only one you're connecting, use a SCSI system cable to connect it to the computer's SCSI port.

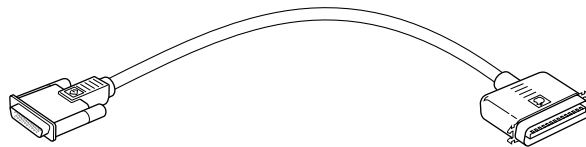

If the device is not the first one, use a SCSI peripheral interface cable to connect it to the last device in the chain.

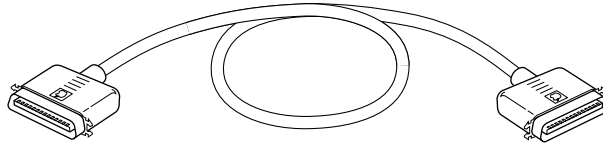

**IMPORTANT** The total length of the cables in a SCSI chain should not exceed 6 meters (20 feet). SCSI cables must have a 110-ohm impedance. For best results, use SCSI cables manufactured by Apple Computer.

- Make sure that the last (or only) device in the SCSI chain has a terminator. Make sure that no other external SCSI device has a terminator.

To ensure accurate transmission of information, a terminator must be at each end of a SCSI chain.

Some external SCSI devices from manufacturers other than Apple have built-in terminators. (Check the information that came with the device.) If the device at the end of the SCSI chain does not have a built-in terminator, you need to attach an external terminator.

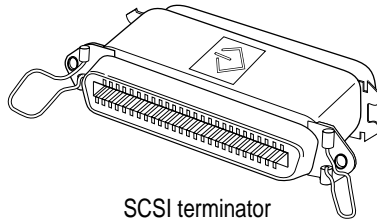

SCSI terminator

If your SCSI device has a built-in terminator, you may choose to use it as your first or last device in the chain, or you may have your Apple-authorized service provider remove any extra built-in terminators. You can attach or remove external terminators yourself.

## Connecting a SCSI device

Use these general instructions in conjunction with the instructions that came with your SCSI device:

- 1 **Turn off your Macintosh.**
- 2 **Make sure the SCSI device is switched off.**

**WARNING** Do not connect or disconnect any device while the device or your Macintosh is turned on. Doing so could damage the device, your computer, or both.

- 3 **Use a SCSI cable to connect the device either to the computer's SCSI port or to the last SCSI device already in the chain.**
- 4 **Turn on the devices in your SCSI chain.**

**IMPORTANT** Always turn on any external SCSI devices connected to your Macintosh before turning on the computer itself. Otherwise, your computer won't be able to recognize that the SCSI devices are connected to it and your computer may not be able to start.

*Note:* If you experience problems after connecting a SCSI device, see the troubleshooting information in Chapter 6 for possible solutions.

## Expanding memory

The dynamic random-access memory (DRAM) in your computer can be expanded. Installing additional DRAM adds more memory to your computer and expands its capabilities. The *Technical Information* booklet that came with your computer describes how much additional memory can be installed in your Power Macintosh.

Memory for your computer is provided in packages called DRAM Dual Inline Memory Modules (DIMMs). The DIMMs must be the correct type for your computer.

The memory used to display images on the screen (called video RAM, or VRAM) can also be expanded.

**WARNING** To avoid damage to your computer, Apple recommends that only an Apple-certified technician install additional DRAM. Consult the service and support information that came with your computer for instructions on how to contact an Apple-authorized service provider or Apple for service. If you attempt to install additional DRAM yourself, any damage you may cause to your equipment will not be covered by the limited warranty on your computer. See an Apple-authorized dealer or service provider for additional information about this or any other warranty question.

It is very important that the DRAM DIMMs be correctly installed in your Power Macintosh, because incorrect installation can result in errors, unpredictable results, and damage to your equipment and data.

## Installing internal drives

Your Macintosh can hold up to four internal storage devices. Possible configurations could include a floppy disk drive, a CD-ROM player, and two hard disk drives (several capacities are available) or a CD-ROM player, a floppy disk drive, a removable hard drive, and a DAT drive. Depending on the configuration you purchased, these storage devices may already be installed. If you want to add an internal drive to your Macintosh, see your Apple-authorized dealer. Refer to the *Technical Information* booklet that came with your Macintosh for more information about internal drives.

## Connecting network cables

Your Macintosh can be connected to a high-speed Ethernet network via an AAUI Ethernet connector or a high-speed 10BASE-T Ethernet connector. You can also connect to a LocalTalk network.

It is possible to be physically connected to more than one kind of network at the same time, but you can use only one of your connections at a time. If both 10BASE-T and AAUI networks are connected, your Macintosh automatically uses the 10BASE-T connection. If 10BASE-T and LocalTalk are connected, your Macintosh uses the 10BASE-T connection. If AAUI and LocalTalk are connected, your Macintosh uses the AAUI connection.

## About Macintosh networking

Your Power Macintosh can connect to a network that consists of as few as two computers or as many as thousands or even millions of computers and other devices. The network allows you and the other people connected to it to share information, access remote services, and share computing resources such as printers and modems.

A network extends the features of your Macintosh by extending your reach to the services and resources provided on the network. For example, your computer alone lets you store, retrieve, and modify information on floppy disks, hard disks, and CD-ROM discs. On a network, however, you can also store and retrieve information on the hard disks and CD-ROM discs of other computers, access information that other people have stored for you, or use mail or other network services.

Your computer comes equipped with two built-in network interfaces: LocalTalk and Ethernet. You can also purchase additional Peripheral Component Interconnect (PCI) cards for alternative networks such as TokenRing, ISDN, or FDDI.

To connect your computer to a network you need to do two things: connect your computer to the network using the appropriate cable, and set up your network configuration in the AppleTalk control panel, the TCP/IP control panel, or both.

To set up your network configuration, open the AppleTalk control panel to choose the physical network interface you are using. (The AppleTalk control panel also contains zone information—a default zone is chosen for you.) If you plan to use TCP/IP on your Power Macintosh, you also need to choose settings in the TCP/IP control panel. You can set up your connection in two ways: manually, by entering a static Internet address, or automatically by using a network service to connect with a dynamic Internet address. Refer to the “Networks” or “Networking & Communications” topic of Macintosh Guide, available in the Guide (🔍) menu for more information on setting up network configurations.

If you’re using a static Internet address, you’ll need the following information before configuring your system (your network administrator or Internet access provider can provide this information):

- **Internet (IP) address:** for example, 192.3.232.55
- **Domain name and domain name server address:** A domain connects an Internet address to a name for your site, for example, acme.com. Enter your Domain name or type a period (.).
- **Gateway address:** This address provides the path the information will take through the network at your site to reach the Internet.
- **Subnet mask:** A subnet mask further defines the location of your machine. You don’t need to change the default unless instructed to do so by your network administrator.

If you’re using a server on the network that will be issuing you an Internet address using a technique called bootstrapping, then you need to decide what protocol you will use: BOOTP (BOOTstrap Protocol), or DHCP (Dynamic Host Configuration Protocol). Your network administrator will tell you which to choose.

If you see an error message after configuring your AppleTalk and TCP/IP control panels, such as, “Unable to locate host,” or “Could not create a socket,” this could indicate a problem in the TCP/IP configuration. Contact your network administrator for additional assistance.

Read this chapter for information on installing and working with application programs on your computer.

# 4

## Installing and Using Application Programs



Your computer has several application programs already installed, as well as some programs that need to be installed before you can use them. The programs that come with your computer include

- AppleScript, which allows you to automate any actions you perform repeatedly on your Macintosh
- Drive Setup, which enables you to initialize, test, and update hard disks and other storage media. Drive Setup lets you partition very large disks (up to 2 terabytes)
- PowerTalk, which provides built-in mail and collaboration services
- QuickDraw GX, which gives your computer more powerful printing and typographical capabilities
- Text-to-speech software that allows your Macintosh to speak typed text in compatible applications such as SimpleText

You'll find most of these plus other programs in the Apple Extras folder on your hard disk. (Drive Setup is in the Utilities folder.) To find out if a program needs to be installed, look inside the program's folder for an icon labeled Installer. If you find an Installer icon and want to use that program, double-click the Installer and follow the instructions on the screen.

**IMPORTANT** If your computer did not come with a CD-ROM player and you did not get the CD-ROM disc that contains system software, be sure to make a backup copy of the programs in the Apple Extras folder. Backup copies allow you to restore your software if anything should go wrong. It is always a good idea to make backup copies of application programs and other software.

## Installing application programs

You'll probably want to buy and install additional programs. See the manuals you receive with your programs for instructions on installing and using them.

In most cases, you'll install an application program on your internal hard disk from a CD-ROM disc that contains the program. The illustration shows how to insert a CD-ROM disc into your computer's disk drive, with the disc lying flat, label side up.

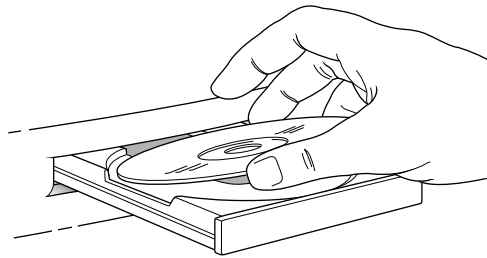

For instructions on how to eject CD-ROM discs, see “Ejecting a CD-ROM Disc” in Chapter 5. Some application programs come on floppy disks. See the “Disks” topic of Macintosh Guide, available in the Guide (⌘) menu for information on inserting and ejecting floppy disks.

To use your programs most effectively, follow these guidelines:

- To avoid installation problems, turn off virus protection programs and use Apple Extensions Manager to turn off system extensions (except for Macintosh Easy Open) before you install any software. To start Apple Extensions Manager, restart your computer while holding down the space bar. Use Apple Extensions Manager to turn off all system extensions except Macintosh Easy Open (this extension is needed to rebuild the desktop correctly). To turn extensions back on, use Apple Extensions Manager to turn them on, then restart your computer.
- Put only one copy of each program on your hard disk. Having more than one copy can cause errors.
- Whenever you copy a program disk to your hard disk, be careful not to copy a System Folder. Always check to see what you've copied, and drag any extra System Folders to the Trash.
- If a program malfunctions consistently, try installing a fresh copy. If that doesn't help, find out from the software manufacturer whether your version of the program is compatible with the hardware and system software you're using.

## Working with several programs at a time

You can open as many application programs and desk accessories as your computer's memory allows.

All open programs are listed in the Application menu at the right end of the menu bar. The name of the active program (the one you're using right now) has a checkmark next to it, and its icon appears in the menu bar.

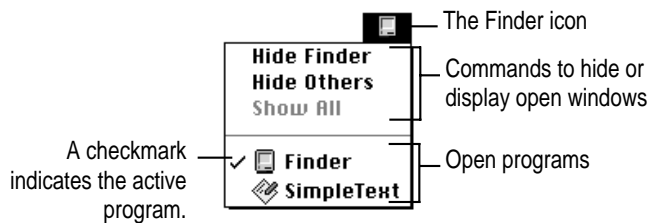

## Finding out which programs are open

If you have several programs and windows open, you can find out which program is active and which other programs are open by pulling down the Application menu.

## Switching programs

You can switch to another open program or desk accessory by choosing its name from the Application menu.

If a program's icon is dimmed in the menu, that means its windows are hidden. Choosing the program from the Application menu displays its windows.

You can also switch to another program by clicking in a window that belongs to an open program, by double-clicking a program icon, or by double-clicking the icon of a document that was created with the program.

## Hiding and showing windows on the desktop

You can hide all windows except those of the active program by choosing Hide Others from the Application menu.

The other programs remain open even though their windows are hidden. When you switch to another program, its windows become visible again.

If you want to see all the open windows, choose Show All from the Application menu.

## Backing up your files

Making backup copies of important files is good protection against possible damage to the originals.

- You can back up files stored on your hard disk by copying them to floppy disks.
- You can back up an entire floppy disk by copying it to another floppy disk of the same capacity or larger, or by copying it to a hard disk.
- You can use a commercial backup program to copy new and changed files from a hard disk to another hard disk, to a tape drive, or to a series of floppy disks.
- If your computer is on a network, you may be able to back up files by copying them to a shared disk on the network.

## Using Power Macintosh application programs

Your Power Macintosh is compatible with most application programs intended for use with Macintosh computers. But certain programs are designed especially for Power Macintosh computers. (These are sometimes called “native” applications.) You’ll find that these programs take best advantage of your computer’s speed.

### Special memory requirements

Some Power Macintosh programs may be slightly larger than other programs and may take up more memory. If you find that you are running out of memory when you use your Power Macintosh programs, you can use space on your computer’s hard disk as additional memory. For instructions on how to use hard disk space as memory, see the “Memory” topic of Macintosh Guide, available in the Guide (🔍) menu.

You can also have more memory added to your computer, as described in “Expanding Memory” in Chapter 3.

## Shared libraries

Power Macintosh programs use special files called *shared libraries*. These files help Power Macintosh programs to run more efficiently, and can be used by more than one Power Macintosh program simultaneously. Any necessary shared libraries are installed automatically in the System Folder when you install Power Macintosh programs.

If a Power Macintosh program requires a shared library and there is not enough memory available for the shared library, you'll see a message that the program could not be opened because of insufficient system memory. If this happens, see the "Memory" topic of Macintosh Guide, available in the Guide (⌘) menu, for instructions on turning on virtual memory.

If a required shared library is missing, you'll see a message that the program could not be opened because the shared library could not be found. If this happens, follow the directions that came with your program to reinstall the program. If the shared library is still missing, contact the program's manufacturer for assistance.

Read this chapter for information on using the internal CD-ROM player, if your computer has one.

# 5

## Using the Optional CD-ROM Player



This chapter provides information on the optional CD-ROM player. Refer to Appendix A, “Health, Safety, and Maintenance Tips” for information on the proper handling of these discs.

Your internal CD-ROM (Compact Disc Read-Only Memory) player for Macintosh computers works with CD-ROM discs, standard audio compact discs (CDs), and single-session or multisession Photo CDs. Your CD-ROM player provides access to large amounts of information. However, you cannot save information on CD-ROM discs. ROM stands for *read-only memory*, meaning that the player cannot “write” information onto CD-ROM discs.

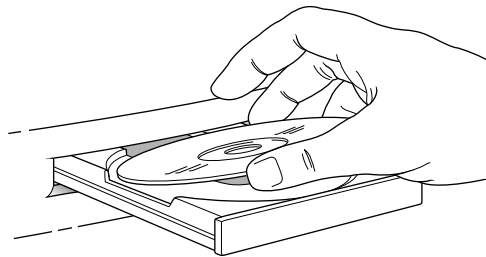

A wide selection of CD-ROM discs is available for entertainment, education, and business. A typical disc can hold over 650 megabytes (MB) of information—the equivalent of 270,000 pages of text, up to 8 hours of speech or music (depending on the sound quality), hundreds of high-resolution images, or any combination of text, sound, and graphics.

## Inserting a CD-ROM disc

Follow these instructions to insert a CD-ROM disc into your CD-ROM player. Then follow the instructions provided with your disc, as well as the instructions in this manual.

- 1 Start up your Macintosh computer, if it's not already on.**
- 2 Press the Open/Close button to open the tray of the CD-ROM player.**

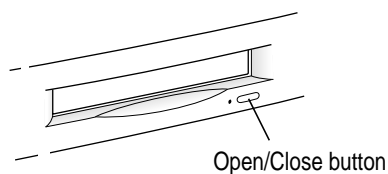

The tray opens.

- 3 Place a CD-ROM disc in the tray, with the disc label facing up.**

Make sure the disc is lying flat and centered in the tray. If you are using a small (8 cm) disc, make sure it is centered within the inside ring on the tray.

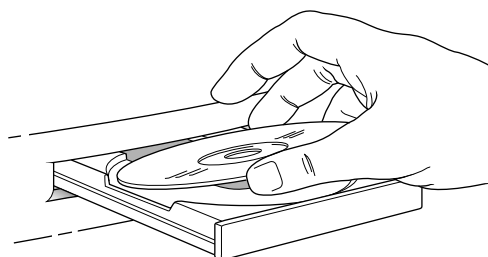

- 4 Push the tray in, or press the Open/Close button, to close the tray.**

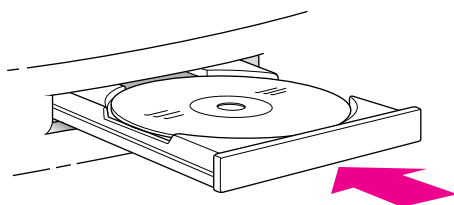

In a few moments, an icon for the CD-ROM disc appears on your screen.

## Ejecting a CD-ROM disc

Follow these instructions to open the tray and eject a CD-ROM disc from your computer.

**IMPORTANT** You may not be able to eject a disc if it is being shared. To turn off file sharing, use the Sharing Setup control panel.

### 1 Open the tray.

There are several ways to open the tray of your CD-ROM player.

*If a CD-ROM disc icon appears on your screen:*

- Select the disc icon on your screen and drag the icon to the Trash.
- Click the disc icon, then choose the Put Away command in the File menu.
- While the AppleCD Audio Player window is active, choose Eject CD from the File menu, or simultaneously press the ⌘ and E keys. (AppleCD Audio Player is a program that allows you to control your CD-ROM player and is available in the Apple [🍏] menu.)

*If no CD-ROM disc icon appears on your screen:*

- Press the Open/Close button for your CD-ROM player.

### 2 Take the CD-ROM disc out of the tray.

Store your disc in a safe place, away from heat, dust, and moisture.

### 3 Push the tray in, or press the Open/Close button, to close the tray.

To avoid possible damage to the tray or the CD-ROM player, keep the tray closed when you are not using it.

## Playing audio CDs

With your CD-ROM player and your computer's built-in speaker, you can play audio compact discs (CDs) or audio tracks on CD-ROM discs. You can also attach headphones or speakers to the computer to listen to audio CDs and audio tracks. See Chapter 3, "Connecting Additional Equipment," for information on connecting sound equipment to your computer.

To start, stop, and otherwise control audio discs, use the AppleCD Audio Player program, available in the Apple (🍏) menu. Your audio CD software will only play tracks that contain audio information. You can listen to an audio CD or audio tracks in the background while you do other work on your computer. For more information about playing audio CDs, see the "CD-ROM Discs" topic of Macintosh Guide, available in the Guide (🔍) menu.



## Working with Photo CDs

You can use your CD-ROM player to open Photo CD images stored on Photo CDs. A Photo CD image is a digitized version of a standard photograph that you can open and view on your computer screen.



You can do many things with the images on your Photo CDs:

- Open and view the images individually on your computer screen.
- View the images on your computer screen in a series, as you would view a slide presentation.
- Copy and save the images, print them, paste them into word-processing documents or other documents that accept graphics, and edit them with a graphics application program.

Photo CD images are an excellent source of graphics for desktop publishing, multimedia presentations, business documents, and professional-quality graphic design. For more information on working with Photo CD images, see the “CD-ROM Discs” topic of Macintosh Guide, available in the Guide (⌘) menu.

## Sharing a CD-ROM disc over a network

You can share a CD-ROM disc using your computer's file-sharing feature. If the disc has audio portions, you will be able to hear the audio yourself, but other people on the network will not. Likewise, you cannot hear the audio portions of discs you access over a network.

For further information about file sharing, see the “Networks and Telecommunications” or “Sharing Files” topic of Macintosh Guide, available in the Guide (📖) menu.



Chapter 6 Troubleshooting

II  
*part*

A decorative graphic consisting of a white wavy line that starts from the left, curves up and then down, ending in a white rectangular shape. The text 'II' and 'part' is overlaid on the right side of this graphic.



Consult this chapter if you experience problems using your computer.

# 6

## Troubleshooting



### When you have questions

If you want to know how to do a particular task with your computer, refer to Macintosh Guide in the Guide (🔗) menu. For instructions on using Macintosh Guide, see Chapter 2 of this manual.

### If you have trouble

While you're using your computer, you may occasionally see a bomb icon or an error message, or the pointer (⏏) may “freeze” on the screen. If you have trouble with your computer, take a few minutes to read the information in this chapter. If your problem is related to a particular procedure, you should also look for information on that procedure in Macintosh Guide, available in the Guide (🔗) menu. For additional troubleshooting information and a list of common questions relating to your system software, see the “Troubleshooting” topic of Macintosh Guide.

If you are unable to access Macintosh Guide (for example, if your screen is “frozen”), refer to this chapter to see if you can resolve the problem.

## Take your time

When you see an error message, you don't have to take action immediately. The message stays on the screen until you click the OK (or Restart) button or turn off the Macintosh.

To help diagnose and correct the problem, gather as much information on the situation as you can. Then follow the instructions in the next section, "Start Over."

- Make a note of exactly what you were doing when the problem occurred. Write down the message on the screen and its ID number (if any). Also list the programs you were using and the names of any items you know have been added to the System Folder since the system software was installed. This information will help a service person diagnose the problem. (It is helpful to keep a printed copy of the items in your System Folder. For instructions on printing the contents of a folder, see the "Printing" or "Printing & Fonts" topic of Macintosh Guide, available in the Guide [?] menu.)
- Check the screen for any clues. Is a menu selected? What programs and document icons are open? Note anything else that seems relevant.
- If you were typing text and were not able to save it before the problem occurred, you can write down the parts of the text still visible on the screen so that some of your work will be easy to replace.
- Ask other Macintosh users about the problem you're having; they may have a solution for it.

If you need repair service, consult the service and support information that came with your computer for instructions on how to contact an Apple-authorized service provider or Apple for assistance.

If you know that the problem is with a particular application program, contact the manufacturer of that software for assistance.

## Start over

Often you can eliminate a problem simply by clearing the computer's memory and starting over.

If you can, save any open documents before restarting the Macintosh. If your system is frozen and does not respond to anything you do, or if you have a “bomb” message on the screen, saving may not be possible. You can try pressing ⌘-Option-Esc to quit the program in use when the problem occurred; if this works, you can then save the documents open in other programs before restarting. (Be sure to restart the computer immediately after you save your documents; quitting a program using ⌘-Option-Esc may leave corrupt data in the computer's memory. This corrupt data is erased when you restart the computer.)

To restart your Macintosh, try the following solutions:

- **If you can, choose Restart from the Special menu or from the dialog box that's on the screen.**

Dialog boxes contain messages from the computer. If something goes wrong, a message may appear on the screen, asking you to restart the computer.

- **If you can't choose Restart, hold down the ⌘ and Control keys while you press the Power key on the keyboard (marked with a triangle).**

This key combination restarts the computer. (Use this key combination only when you can't choose Restart from the Special menu.)

- **Turn off your computer with the power button on the front panel of the computer, wait at least 10 seconds, and then turn it on again.**

If the computer does not turn off, try pressing and holding down the power button for 3–4 seconds.

- **If the power button doesn't turn off the computer, unplug your Macintosh.**
- **If you suspect that the problem is with other equipment, such as a printer or an external hard disk that's attached to your computer, turn that equipment off for 10 seconds or longer, then turn it on again and restart the Macintosh.**

## Rebuild your desktop regularly

A process known as “rebuilding the desktop” helps your Macintosh keep track of data on your startup disks. Although you usually use the hard disk in your computer as a startup disk, you can also start up from any other disk that has system software installed. It’s a good idea to rebuild the desktop of your startup disks regularly.

To rebuild the desktop of a startup disk, follow these steps:

- 1 Hold down the Option and ⌘ keys while you start up your computer.**

Do not release the keys until you see a message asking whether you want to rebuild the desktop.

- 2 Click OK.**

## Solutions to common problems

This section contains descriptions of problems you could experience with your computer. Some problems may be caused by your CD-ROM player, so if you don’t find your problem here, be sure to check the section, “Solutions to CD-ROM Problems,” later in this chapter.

### The computer is turned on but the screen is dark.

One of the following is probably the cause:

- You have a screen saver program that darkens the screen when the computer has not been used for a certain period.  
Press a key or move the mouse to turn off the screen saver.
- The computer is in sleep mode. Press a key on the keyboard and/or move the mouse.
- The monitor’s brightness control (☼) is not adjusted properly.  
Check the monitor’s brightness control and turn it up if necessary.

- The Macintosh or the monitor is not getting power.

If you have a separate monitor, check that the monitor is plugged in and turned on, and that the monitor cable is firmly connected to both the computer and the monitor.

Check that the computer's power cord is firmly connected to the computer and plugged into a grounded electrical outlet, and that the outlet has power.

If you have more than one monitor, and only one is dark, check that it is set up correctly in the Monitors control panel. For information on using more than one monitor, see the "Monitors" topic of Macintosh Guide, available in the Guide (⌘) menu.

- If none of these steps solves the problem, you may need to reset your computer's Parameter RAM (PRAM). Reset PRAM by turning off the computer and disconnecting all external SCSI devices. Next, restart the Macintosh while holding down the key combination ⌘-Option-p-r. Wait for the second startup chime, then release the keys. (Note that the "caps lock" key must be in the up position. This procedure won't work with the uppercase "P" and "R" keys.)

If you are displaying video from your computer on a television screen, it is normal for your computer monitor to be dark.

**The computer's clock keeps time inaccurately.**

Your computer has a clock that runs continuously. When the computer is turned off, a battery keeps the clock running. If your clock begins to keep time inaccurately, have an Apple-authorized service provider replace the battery. Consult the service and support information that came with your computer for instructions on how to contact an Apple-authorized service provider or Apple for assistance.

When you start up, a disk icon with a blinking question mark appears in the middle of the screen.



This icon indicates that your Macintosh cannot find the system software it needs to start up. One of the following is probably the cause:

- Your computer may be having a problem recognizing external equipment that uses the Small Computer System Interface (SCSI).

Shut down the computer, turn off all external SCSI equipment, and disconnect the first SCSI device in the chain from your computer's SCSI port. Then restart the computer. If the computer starts up after you disconnect your SCSI equipment, refer to the manuals that came with the equipment for information on the proper way to connect SCSI equipment and assign SCSI ID numbers.

If you have a printer connected to your computer's SCSI port, make sure your printer is not supposed to be connected to the printer port instead. Check the manuals that came with your printer for information on how to properly connect it.

- System software may not be installed on the startup hard disk, the system software may be damaged, or the hard disk may not be working properly.

Start up your computer using the *Disk Tools* floppy disk or (if you have a built-in CD-ROM player) with the CD-ROM disc that contains system software. (For instructions on how to start up your computer from the CD-ROM disc, see "Starting Up From a CD-ROM Disc" in the section "Initializing a Hard Disk" later in this chapter.) Then follow the instructions in "Repairing a Damaged Disk" later in this chapter to test your startup hard disk and repair any damage.

If repairing the disk doesn't help, follow the instructions in "Installing or Reinstalling System Software" later in this chapter to reinstall system software on your startup hard disk.

**When you try to start up from a floppy disk, a disk icon with an X appears in the middle of the screen and the floppy disk is ejected.**



This icon indicates that the floppy disk you tried to start up from is not a startup disk.

Wait a few seconds. The computer should start up from its internal hard disk. Make sure you insert floppy disks only after the computer has begun starting up.

**A “sad Macintosh” icon appears and the computer won’t start up.**



This icon indicates that your Macintosh cannot start up because of a problem with the system software or the computer hardware.

Eject any floppy disks by turning off the computer and then holding down the mouse button while you turn the computer on again. Try starting up with the *Disk Tools* floppy disk or (if you have a built-in CD-ROM drive) with the CD-ROM disc that contains system software. (For instructions on how to start up your computer from the CD-ROM disc, see “Starting Up From a CD-ROM Disc” in the section “Initializing a Hard Disk” later in this chapter.) If the “sad Macintosh” icon appears again, consult the service and support information that came with your computer for information on contacting an Apple-authorized service provider or Apple for assistance.

### **The hard disk icon does not appear on the desktop.**

If you don't see a hard disk icon on the desktop, try the following:

- Use the Drive Setup program to make the disk available. Drive Setup is located in the Utilities folder on your hard disk. For instructions, start Drive Setup, then choose Drive Setup Guide from the Guide (Ⓜ) menu.
- If the hard disk is internal, shut down your computer, wait at least 10 seconds, and then turn it on again.
- If the hard disk is external, make sure that it is turned on and that its cable is connected firmly; then restart the Macintosh.
- Check the ID numbers of all SCSI equipment connected to your computer. No two SCSI devices on the same SCSI chain can have the same ID number. In addition, there are special requirements for assigning SCSI ID numbers that don't conflict with your computer or its internal storage devices. See Chapter 3 and the manuals that came with your SCSI equipment for information on setting SCSI ID numbers.
- If the hard disk is your startup disk, start your computer using the *Disk Tools* floppy disk or (if you have a built-in CD-ROM player) with the CD-ROM disc that contains system software. (For instructions on how to start up your computer from the CD-ROM disc, see “Starting Up From a CD-ROM Disc” in the section “Initializing a Hard Disk” later in this chapter.) Then follow the instructions in “Repairing a Damaged Disk” later in this chapter to test your startup hard disk and repair any damage.

If repairing the disk doesn't help, follow the instructions in “Installing or Reinstalling System Software” later in this chapter to reinstall system software on your startup hard disk.

### **Icons do not appear correctly on your screen.**

You need to rebuild the desktop—a process that helps your Macintosh keep track of files and folders on your hard disk. For instructions, see “Rebuild Your Desktop Regularly” in the section “If You Have Trouble” earlier in this chapter.

If icons do not appear correctly after you rebuild the desktop, restart your computer while pressing the Shift key to temporarily turn off system extensions. When you see the “Welcome to Macintosh—extensions off” message, release the Shift key and press the Option and ⌘ keys simultaneously until you see a message asking if you want to rebuild the desktop.

### **Your Macintosh can't read a floppy disk.**

If you see a message that a floppy disk is unreadable, try one of the following:

- If the disk has never been used, you may simply need to initialize it. For instructions, see the “Disks” topic of Macintosh Guide, available in the Guide (🔍) menu.
- The disk may be damaged. See “Repairing a Damaged Disk” later in this chapter for information on testing and repairing disks.
- If the disk is a high-density disk previously used on another computer, the disk may have been formatted incorrectly as an 800K disk rather than as a 1440K (high-density) disk. If so, use the other computer to copy the disk's contents onto a properly formatted disk.
- The disk may have been formatted for use on another kind of computer. You may be able to use a program that lets you work with such disks on your Macintosh.

If you are trying unsuccessfully to use a DOS floppy disk, consider the following:

- Make sure Macintosh PC Exchange is installed and turned on. Macintosh PC Exchange is a control panel that allows your Macintosh to read files from DOS computers.
- When formatting floppy disks on a DOS computer for use in a Macintosh, you need to format standard double-sided disks as 720K disks and high-density disks as 1440K disks. Double-sided disks formatted in 1440K format and high-density disks formatted in 720K format may not work in a Macintosh.

If you think your DOS floppy disk might have a format that doesn't work with a Macintosh, use a DOS computer to copy the contents of the disk onto a properly formatted disk.

### You can't eject a floppy disk

If you can't eject a floppy disk in the usual way, try the following in order:

- Hold down the ⌘ and Shift keys and press the number 1 key on your keyboard to eject a disk in the internal disk drive.
- Turn off the computer. If the disk isn't ejected, then hold down the button on your mouse or other pointing device while you turn the computer on again.
- Locate the small hole near the disk drive's opening, and carefully insert the end of a large straightened paper clip into it. Push gently until the disk is ejected. Do not use excessive force.

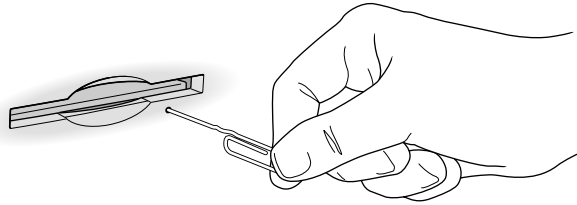

If none of these solutions work, take the computer or disk drive to your Apple-authorized service provider to have the disk removed.

### You installed a CD-ROM player after you bought your computer and your computer won't restart after you've copied software for your CD-ROM player to the System Folder.

- If you attempt to install software for your CD-ROM player without using the Installer, you may not be able to restart your computer. Restart the computer with the Shift key held down (to turn off system extensions), then remove any CD-ROM software files you copied by dragging them to the Trash. Reinstall the software according to the instructions that came with the drive.

If this procedure doesn't solve the problem, start your computer using the *Disk Tools* floppy disk or the CD-ROM disc containing system software that came with your computer. (For instructions on starting your computer using a floppy disk, see "Starting Up From a Floppy Disk" in the section "Initializing a Hard Disk," later in this chapter.)

**Your computer won't restart and there is a CD-ROM disc inside the CD-ROM player.**

- Your computer may be trying to start up from the CD-ROM disc. Press the Open/Close button on the front of the computer to open the tray, and remove the CD-ROM disc. Close the tray, then restart your computer.

**Your computer starts up and you see large folder-shaped areas, containing labeled pictorial buttons, instead of the usual Macintosh desktop.**

- Your computer may have started up from a CD-ROM disc containing At Ease, an alternative to the Macintosh desktop. You need to have the Macintosh desktop on your screen before you can use the installation instructions in this manual.

To return to the Macintosh desktop, choose Shut Down from the Special menu. When your computer is off, press the Open/Close button of your CD-ROM player to open the tray, then remove the CD. Close the tray. Then start up your computer again.

To avoid having the computer start up from a CD-ROM disc, remember to remove any disc in the drive before you shut down your computer.

**You can't start an application program or it quits unexpectedly. Or, when you try to open a program, you see a message that not enough memory is available.**

One of the following is probably the cause:

- The Macintosh ran out of memory.

Quit the programs that you have open and then open the program you want to use, or restart your Macintosh.

Use the Memory control panel to turn on virtual memory. (This is especially important if you have a Power Macintosh computer or Power Macintosh upgrade card and are using programs designed specifically for the Power Macintosh.) For more information on virtual memory, see the "Memory" topic of Macintosh Guide, available in the Guide (🔍) menu.

- The program needs more memory.

Use the program's Info window to give it more memory. For more information on increasing a program's memory, see the "Memory" topic of Macintosh Guide, available in the Guide (🔍) menu.

- The program is a 68K application running in emulation mode that requires a separate floating-point unit (FPU). It cannot use the built-in FPU on your computer's microprocessor.

Check the documentation that came with the program to find out if the program requires the FPU found in the 68K chip. If it does, you may need to upgrade to a Power Macintosh version of the program, or install software that emulates the 68K FPU.

- Sometimes incompatible system extensions or control panels can cause software problems. Restart while holding down the Shift key to temporarily turn off all system extensions.

If your program works normally after you do this, use the Extensions Manager control panel to turn off individual extensions and control panels. For detailed instructions, see the "Customizing Your Computer" or "Setting Options" topic of Macintosh Guide, available in the Guide (📖) menu.

If your program performs better when a particular extension or control panel is turned off, contact the software's manufacturer for information or an upgrade.

#### **A dialog box with a bomb appears.**

Your system has a software problem.

- Write down what you were doing when the message appeared, and write down the message.
- Restart your Macintosh. (See "Start Over" in the section "If You Have Trouble," earlier in this chapter, for instructions.) Most software problems are temporary, and restarting usually corrects the problem.
- Check the startup disk and application program you were using when the dialog box appeared. Make sure that all programs, desk accessories, and system extensions you're using are compatible with the system software. Reinstalling the system software may correct the problem.
- If the bomb only occurs in one application program, try reinstalling the program from the original disks. If reinstalling doesn't solve the problem, contact the manufacturer of the program.

- Sometimes incompatible system extensions or control panels can cause system software problems. Restart while holding down the Shift key to temporarily turn off all system extensions.

If your computer works normally after you do this, use the Extensions Manager control panel to turn off individual extensions and control panels. For detailed instructions, see the “Customizing Your Computer” or “Setting Options” topic of Macintosh Guide, available in the Guide (📖) menu.

If your computer performs better when a particular extension or control panel is turned off, contact the extension’s or control panel’s manufacturer for information or an upgrade.

- If the problem recurs, you may need to reinstall system software. See “Installing or Reinstalling System Software” later in this chapter for instructions.

**The pointer (↔) doesn’t move when you move the mouse.**

One of the following situations is probably the cause:

- Your system has a software problem.

Press ⌘-Option-Esc to quit the application program in use when the problem occurred. If this works, you can save the documents open in other programs before restarting.

If that doesn’t solve the problem, follow the suggestions in the previous section, “A Dialog Box With a Bomb Appears.”

- Your keyboard or mouse cable connection may have been loosened or disconnected. Turn the computer off using the power button on the front of the computer, check that the mouse and keyboard cables are connected properly, and then restart the computer.

**IMPORTANT** Do not connect or disconnect the mouse or keyboard while the computer is turned on. You may damage your computer.

- Signals from the mouse are not reaching the computer, either because the mouse needs cleaning or because there is something wrong with the mouse.

Clean the mouse according to the instructions in Appendix A of this book.

If you have another mouse or pointing device, try connecting and using it. (Turn off the computer before connecting it.) If the new device works, there is probably something wrong with the mouse you replaced.

If none of these procedures solves the problem, consult the service and support information that came with your computer for instructions on how to contact an Apple-authorized service provider or Apple for assistance.

**Typing on the keyboard produces nothing on the screen.**

One of the following is probably the cause:

- If the computer beeps every time you press a key, Easy Access is probably turned on.

Open Easy Access from the control panels listed under the Apple (🍏) menu and turn it off.

- You haven't selected any text or set the insertion point (I).

Make sure the program you want to type in is the active program. Then place the pointer (⏏) in the active window and click to set an insertion point (I) or drag to select text (if you want to replace the text with your typing).

- The keyboard is not connected properly.

Turn off the computer using the power button on the front of the computer, then check that the keyboard cable is connected properly at both ends.

If you have a keyboard with an ADB port (marked with the ⌘ icon) on each end, turn off the Macintosh using the power button and plug the keyboard cable into the other ADB port on the keyboard. (You may have to unplug the mouse to do this.) Then restart the computer.

- The keyboard is damaged.

If you have access to another keyboard, try using it instead. (Turn the computer off before connecting it.) If the new keyboard works, there is probably something wrong with the one you replaced.

- Your system has a software problem.

Restart your Macintosh. For instructions, see “Start Over” in the section “If You Have Trouble” earlier in this chapter.

Check the startup disk and application program you were using when the problem occurred. Make sure that all programs, desk accessories, and system extensions you’re using are compatible with the system software.

If the problem recurs, try restarting the computer with system extensions turned off. (To turn system extension off, hold down the Shift key while restarting the computer.) If that doesn’t work, you may need to reinstall system software. See “Installing or Reinstalling System Software” later in this chapter for instructions.

If none of these procedures solves the problem, consult the service and support information that came with your computer for instructions on how to contact an Apple-authorized service provider or Apple for assistance.

**You can’t open a document, or you see a message that an application program can’t be found.**

- Some documents can be opened by more than one application program. Try starting a program that you think might be able to open the document, then choose Open from the program’s File menu to try to open the document.
- Purchase and install the correct software to use the document, or find out if the creator of the document can convert it to a form that one of your programs can use.
- Don’t try to open the files in your System Folder. Most of the files in your System Folder are used by your computer for internal purposes and are not intended to be opened.
- Rebuild your desktop by holding down the Shift key while starting up your computer. Keep holding down the Shift key until you see a message that extensions are turned off; then hold down the Option and ⌘ keys. Keep holding down the Option and ⌘ keys until you see a message asking whether you want to rebuild the desktop. Click OK.
- If the document is from a DOS computer, use the PC Exchange control panel to specify which Macintosh program will open the document. For information about working with DOS documents on your Macintosh, see the information about DOS in Macintosh Guide, available in the Guide (🔍) menu.

**You experience problems using a document from a DOS computer.**

If you can't open a DOS document using a Macintosh program, try the following:

- Open the document from within the program by choosing Open in the program's File menu.
- Use the PC Exchange control panel to specify which Macintosh program will open the document.

If a DOS document is displayed incorrectly, or you see strange codes or characters in the document, try one of the following:

- Your application program may have special procedures for opening and saving documents with different file formats. See the information that came with your program.
- Try opening the document in another program.

*Note:* Some characters that can be displayed on the Macintosh are not accurately displayed on DOS computers, and vice versa.

For more information about working with DOS documents on your Macintosh, see the information about DOS in Macintosh Guide, available in the Guide (Ⓜ) menu.

**You see a message that your application program can't be opened because a file can't be found.**

Power Macintosh programs use special files called *shared libraries*. Any necessary shared libraries should be installed automatically when you install Power Macintosh programs.

Follow the directions that came with your program to reinstall the program. If the shared library is still missing, contact the software program's manufacturer for assistance.

**You experience problems using an older Macintosh program.**

Some older Macintosh programs are not completely compatible with Power Macintosh computers. Check with the program's manufacturer for compatibility and upgrade information.

Open the Memory control panel and turn off Modern Memory Manager. For more detailed instructions, see the "Working with Programs" topic of Macintosh Guide, available in the Guide (📖) menu.

## Solutions to CD-ROM problems

### Problems using the CD-ROM player

**The CD-ROM player icon does not appear on screen.**

- If you have other internal SCSI devices attached to your computer, make sure that each device has a unique SCSI ID number. (If your CD-ROM player was installed in your computer at the factory, it has SCSI ID 3)

Refer to the documentation that came with your SCSI devices if you need to reset SCSI ID numbers.

*Note:* Your computer also has an external SCSI connector. All devices on the same SCSI chain must have unique ID numbers, but devices on different SCSI chains may use the same SCSI ID number. (For example, you could have a CD-ROM player with ID number 3 connected to the internal SCSI chain and a tape drive with ID number 3 connected to the external SCSI chain.)

- If you installed a CD-ROM player after you bought your computer, make sure the CD-ROM software that came with the drive is installed. See the manual that came with the CD-ROM player for software installation instructions.
- If you reinstall the CD-ROM software, make sure to restart your computer after you reinstall the software.

**If you installed a CD-ROM player after you bought your computer and your computer won't restart after you've copied software for your CD-ROM player to the System Folder.**

- If you attempt to install software for your CD-ROM player without using the Installer, you may not be able to restart your computer. Restart the computer while holding down the Shift key (to turn off system extensions), and then remove any CD-ROM software files you copied by dragging them to the Trash. Reinstall the software according to the instructions that came with the drive.

If this procedure doesn't solve the problem, start your computer using the *Disk Tools* floppy disk. (For instructions on starting your computer using a floppy disk, see "Starting Up From a Floppy Disk," later in this chapter.)

**Your computer starts up and you see large folder-shaped areas, containing labeled pictorial buttons, instead of the usual Macintosh desktop.**

- Your computer may have started up from a CD-ROM disc containing At Ease, an alternative to the Macintosh desktop. You need to have the Macintosh desktop on your screen before you can use any of the installation instructions in this manual.

To return to the Macintosh desktop, choose Shut Down from the Special menu. When your computer is off, press the Open/Close button of your CD-ROM player to open the tray, then remove the CD-ROM disc. Close the tray. Then start up your computer again.

To avoid having the computer start up from a CD-ROM disc, remember to remove any disc in the CD-ROM player before you shut down your computer.

### **The tray of your CD-ROM player won't open.**

*If a CD-ROM disc icon appears on your screen:*

- Drag the disc icon to the Trash, or select it and choose Put Away from the File menu. If the AppleCD Audio Player program is active, choose Eject CD from the File menu.

If you see a message that a disc can't be put away because it is being shared, turn off file sharing, then try again to put away the disc.

*If no CD-ROM disc icon appears on your screen:*

- Press the Open/Close button for your CD-ROM player.
- The signal to open the tray may not be reaching the computer. Turn off your computer and locate the small pinhole to the lower right of the CD-ROM tray opening. Insert the end of a large, straightened paper clip firmly and horizontally into the pinhole. Push gently until the tray is released, then carefully pull the tray open. Do not force the tray open; wait until the paper clip has dislodged it or you may break the front of the tray.

**WARNING** Turn off your computer before you attempt to eject the tray using a paper clip. If you don't, you may damage the CD-ROM player.

If neither of these suggestions works, your CD-ROM player may be damaged. Contact an Apple-authorized service provider or Apple for further assistance.

### **Your computer won't restart, and a CD-ROM disc is in the CD-ROM player.**

- Your computer may be trying to start up from the CD-ROM disc. Press the Open/Close button of your CD-ROM player to open the tray, and remove the CD-ROM disc. Close the tray, then restart your computer.

## Problems with CD-ROM discs

**You insert a CD-ROM disc, but its icon doesn't appear on the Macintosh desktop.**

- Make sure that the disc label is facing up and the disc is centered in the tray. If you're using a small (8 cm) disc, make sure it is within the tray's inner ring.
- Make sure the tray is closed all the way.
- Try restarting your computer.
- Try starting your computer from the CD-ROM disc that contains system software while holding the "c" key down. If only the hard drive icon appears on the desktop, then there may be a hardware problem with your CD-ROM player. If the CD-ROM icon appears above the hard drive icon, try reinstalling your CD-ROM software following the instructions in "Installing or Reinstalling CD-ROM Software."
- If you installed the CD-ROM player after you bought your computer, make sure the CD-ROM software is installed. (Refer to the documentation that came with the CD-ROM player.)

CD-ROM software is already installed on Macintosh computers that come with CD-ROM players. You can reinstall it by following the procedure in "Installing or Reinstalling CD-ROM Software" later in this chapter.

**Your computer displays the message "This is not a Macintosh disk: Do you want to initialize it?" when you insert a CD-ROM disc in the CD-ROM player.**

- Make sure that the Foreign File Access and/or Audio CD Access CD-ROM extensions are installed in your System Folder and are turned on. (If they are not turned on, use the Extensions Manager control panel to turn them on and then restart your computer.)
- Make sure the CD-ROM software is installed. (The CD-ROM software is already installed on Macintosh computers that come with CD-ROM players.) If you installed a CD-ROM player after buying your computer, see the manual that came with your player.
- The disc may use a format that the Macintosh cannot recognize.

**Your computer ejects a CD-ROM disc without giving you any error message.**

- Make sure the disc is flat in the tray and the disc label is facing up. If you're using a small (8 cm) disc, make sure it's centered within the tray's inner ring.
- The disc may need to be cleaned. (See "Handling CD-ROM Discs" in the section "Handling Your Equipment" in Appendix A.) If there are visible scratches on the shiny side of the disc, you may be able to remove them with a CD polishing kit (available from your audio CD dealer). If the scratches can't be removed, you'll need to replace the disc.
- The disc may be damaged. Try another disc in the drive, and try the original disc in another drive. If the original drive reads other discs or if the original disc doesn't work in another drive, the disc is probably damaged. You'll need to replace the disc.

**You can't open a document on a CD-ROM disc.**

- Try opening the application program first; then open the document.
- Read the manual that came with your CD-ROM disc. Some discs come with software that you need to install on your computer before using the disc.

**You can't save changes you make to information on a CD-ROM disc.**

- CD-ROM is a read-only medium. This means that information can be read (retrieved) from it, but not written (stored) on it. You can save the changed information on a hard disk or floppy disk.

## **Problems using ISO 9660 or High Sierra discs**

**You cannot access files on a CD-ROM disc that uses the ISO 9660 or High Sierra format.**

- Discs in the ISO 9660 and High Sierra disc formats have version numbers attached to file names. Some application programs need these version numbers in order to work with files. To make the version numbers available to programs on your computer, follow these instructions:

Drag the CD icon to the Trash. When the tray opens, hold down the Option key and push the tray back in, continuing to hold down the Option key until the disc is fully in the drive. The program you are using should now be able to locate file names on that CD-ROM disc.

## Problems playing audio CDs

**You don't hear any sound when you play an audio CD or an audio track on a CD-ROM disc using the AppleCD Audio Player.**

- If your CD-ROM player was installed after you bought your computer, make sure the audio cable is properly connected. See the documentation that came with the CD-ROM player for more information.
- If you have headphones or speakers connected to the computer, adjust the connector to make sure they are firmly connected. Make sure the volume control on your headphones or speakers is not turned down too low.
- If you do not have headphones or speakers connected to the computer, make sure that nothing else is plugged into the sound output port on your computer.
- Some programs change the sound options to suit their needs. You may need to reset the sound options in a control panel. Refer to the “Sound” topic of Macintosh Guide available in the Guide (⌘) menu.
- If you are using a CD-ROM disc over a network, you won't be able to hear the audio portion.
- Make sure the volume is turned up in the AppleCD Audio Player. With the Audio Player open, drag the volume control slider up or press the Up Arrow key on your keyboard.
- The CD may have been paused. Click the Play/Pause button once or twice.

**While playing an audio track on a CD-ROM disc that combines audio tracks and data, you double-click the disc icon and the audio track stops playing.**

- You can't open data files on a CD-ROM disc and listen to audio tracks on that disc at the same time.

**You are unable to record sound from an audio CD.**

- Check your computer's sound input port to see if a microphone or other device is connected.
- You may need to reset the sound options in a control panel. Refer to the “Sound” topic of Macintosh Guide, available in the Guide (⌘) menu.

## Problems using Photo CDs

### Your CD-ROM player will not open Photo CDs.

- Reinstall the CD-ROM software (available through the “MultiMedia Software” option in Custom Install when you reinstall system software).

### Your computer does not display color icons for individual images on a Photo CD.

- Your system may be low on memory. To view color icons, restart your computer and then reopen the Photos folder. See the “Memory” topic of Macintosh Guide, available in the Guide (🔗) menu for more information on managing memory.

### After you open an image on a Photo CD, the image is scrambled, colors are displayed incorrectly, or no image appears in the window.

- The program you are using may not be designed to work with large (high-resolution) image files. You can open the image with another program or you can assign more memory to the program. (For more information on managing memory, see the “Memory” topic of Macintosh Guide, available in the Guide (🔗) menu.)

### After you open an image on a Photo CD, your system is “frozen” and does not respond to any input, or you have a “bomb” message on your screen.

- Restart your Macintosh. The program you are using may not be designed to work with large (high-resolution) image files. You can open the image with another program or you can assign more memory to the program. (For more information on managing memory, see the “Memory” topic of Macintosh Guide available in the Guide (🔗) menu.)

## If your computer's performance decreases

If you notice a decrease in your computer's speed and general performance after you add special software like a control panel, system extension, or custom utility, it may be because this software does not work well with Power Macintosh computers.

- To find out if a system extension is the problem, hold down the Shift key while you restart the computer. This temporarily turns off system extensions. If the computer performs better without this software, one of the system extensions is likely to be the problem. (If you just added a new system extension, it is the most probable cause of the problem.) Return the system extensions to the System Folder one at a time, restarting and checking your computer's performance each time until you identify the extension that is causing problems. Contact the software's manufacturer for information or an upgrade.
- To find out if a new control panel or custom utility you've added is the problem, drag it out of the System Folder. (This software may be in the Control Panels or elsewhere inside the System Folder.) Next, restart your computer and check its performance. If there's an improvement, the new software was probably the cause of the problem. Contact the software's manufacturer for information or an upgrade.

If you don't know which control panel or custom utility is causing the problem, you can drag all of these items out of the System Folder and restart the computer. If the computer performs better when the software is removed, you need to find out which item is causing the problem. Return the control panels and custom utilities to the System folder one at a time, restarting and checking your computer's performance each time until you identify the one that is causing problems.

If you still do not notice an improvement, follow the instructions in "Installing or Reinstalling System Software" later in this chapter to reinstall system software on your startup hard disk.

## Solving printer problems

- *All printers:* Check your printer settings in the Chooser, making sure you have selected the correct printer. Next, turn off the computer and printer and check the printer cable connections. If neither of these suggestions solves the problem, reinstall your printer driver (this software probably came with your printer on a floppy disk).
- *Personal LaserWriter LS, LaserWriter Select 300, and Personal LaserWriter 300:* The system software installed on your computer includes a new version (version 1.2) of the Personal LaserWriter 300 printer driver. This driver works with all three of these printers. Do not install your older Personal LaserWriter LS or LaserWriter Select 300 drivers; the older printer drivers are not compatible with Power Macintosh computers.
- *StyleWriter and StyleWriter II printers:* The system software installed on your computer includes a new version (version 2.0) of the StyleWriter I/II printer driver. This driver works with both the StyleWriter II and the StyleWriter printers. Do not install your older StyleWriter driver; the older driver is not compatible with Power Macintosh computers.

If your printer is different from the ones just mentioned, its driver may not be included on the Power Macintosh hard disk. You should install the driver for your printer if you encounter printing problems. Install the driver from the disks that came with the printer.

## Obtaining updated Apple software

Apple software updates include all of the latest versions of Apple software, including most printer drivers, System Enablers, and updates to utilities, networking, and communication software.

**IMPORTANT** Be sure to read the posted Apple Software License Agreement before installing any software.

Currently, Apple's Customer Service Division (CSD) posts Apple software updates to the following online services:

- AppleLink
- CompuServe
- Internet: Apple Computer Higher Education gopher server
- Internet: ftp.info.apple.com (formerly ftp.austin.apple.com)
- Internet: ftp.support.apple.com

Specific paths and details for each service follow.

### AppleLink

Apple software updates are posted to the APPLE SW UPDATES board located in the following path:

AppleLink Services (main window)  
Software Sampler  
Apple SW Updates

### eWorld

Apple software updates are posted to the Apple Software Updates board located in the following path:

Computer Center  
Apple Customer Center  
Apple Software Updates

## CompuServe

Apple software updates are posted to two separate areas on CompuServe: Apple Support Forum and Apple New Updates. All updates are posted simultaneously to both areas. Updates are removed from the Apple New Updates area after three weeks.

Apple Support Forum (GO APLSUP) contains all software and information libraries. Software is organized by category into separate libraries, including

- System Software
- Apple II
- Newton
- System Enablers
- Printing
- Display & Peripheral Software
- Networking & Communications
- DOS & Windows

Apple New Updates (GO APLNEW) contains all recently published Apple software updates, allowing you to download the latest and most popular Apple Software Updates quickly and easily.

### Internet: Apple Computer Higher Education gopher server

Apple recommends using TurboGopher client software to access the Apple Computer Higher Education gopher server. The “Apple Support Area” folder is located in the following path:

Home Gopher Server  
  Computer Information  
    Apple Computer Higher Education gopher server  
      Apple Support Area  
        Apple SW Updates

TurboGopher Client software is available via anonymous File Transfer Protocol (ftp) to boombox.micro.umn.edu in the /pub/gopher directory.

- Host name: info.hed.apple.com

### Internet: ftp.info.apple.com

This is a File Transfer Protocol (ftp) server with all of the latest Apple software updates. (This ftp site was formerly called ftp.austin.apple.com)

- Host name: ftp.info.apple.com, IP number is: 204.96.16.4
- Path: ftp/Apple.Support.Area/Apple.SW.Updates

You can also download Apple software updates via Apple’s Worldwide Web server, www.info.apple.com. The Apple web site allows you an easy way to download Apple software updates from ftp.info.apple.com.

- URL for the Apple web site is: http://www.info.apple.com
- IP number for the Web site is: 204.96.16.2



## Internet: <ftp.support.apple.com>

This is a File Transfer Protocol (ftp) server with all of the latest Apple software updates.

- Host name: <ftp.support.apple.com>.
- IP number: 130.43.6.3
- Path: /pub/Apple SW Updates

## America Online ftp (file transfer protocol) gateway

You can log onto our <ftp.info.apple.com> server via the America Online ftp gateway. You need an America Online account. Once online, follow these steps:

- 1 Use the keyword “ftp” to take you to the ftp area.
- 2 Click the FTP button (icon of disk with sunglasses).
- 3 In the favorite sites list, double-click “<ftp.info.apple.com>”.

A dialog box will appear with the <ftp.info.apple.com> welcome screen.

- 4 Click the OK button.
- 5 Double-click the `Apple.Support.Area` folder to open it.
- 6 Double-click the `Apple.Software.Updates` folder to open it.

Each time you open a folder, a new Macintosh window opens.

## Initializing a hard disk

Before you can use a new disk, the disk must be prepared so that the computer knows where to store information on the disk. This preparation is called *initializing* (or *formatting*) the disk.

### When do you need to initialize a hard disk?

The hard disk inside your computer was initialized at the factory, so you shouldn't need to initialize it. You need to initialize a hard disk only if

- you purchase a hard disk that has not been initialized at the factory
- your hard disk is damaged

If a hard disk needs to be initialized, the disk's icon does not appear on the desktop when you start up the computer using another disk.

If the hard disk you want to initialize is not the startup disk, you can use the Drive Setup program to initialize it. Drive Setup is located on the floppy disk labeled *Disk Tools* that came with your computer. If your computer came with a CD-ROM player and you didn't receive floppy disks, you can find Drive Setup on the CD-ROM disc that contains system software. For instructions, start Drive Setup and choose Drive Setup Guide from the Guide (Ⓜ) menu.

If the hard disk you want to initialize is the startup disk, follow the instructions in this chapter.

**WARNING** Initializing a disk erases any information that may be on it. Before you initialize a damaged disk, try to repair it as described in “Repairing a Damaged Disk” later in this chapter.

## Starting up from a CD-ROM disc

To initialize, test, or repair a hard disk, or to install system software on a hard disk, you need to start up your computer from another disk. If your computer has a CD-ROM player, you can start up your computer using the CD-ROM disc containing system software that came with the computer.

To start up the computer using the CD-ROM disc, follow these steps:

- 1 Turn your computer on.**
- 2 When you see the desktop on your screen, press the Open/Close button on your CD-ROM player, and insert the CD-ROM disc containing system software into the player.**
- 3 Turn your computer off.**

The CD-ROM disc will remain in the CD-ROM player.

- 4 Hold down the C key on your keyboard and restart your computer.**

Continue to hold down the key until you see the “Welcome to Macintosh” message.

## Starting up from a floppy disk

To initialize, test, or repair a hard disk, or to install system software on a hard disk, you need to start up your computer from another disk. If you don't have a built-in CD-ROM player, you can start up the computer using either the *Disk Tools* or disk 1 from the set of system software disks that came with your computer.

To start up your computer using a floppy disk, follow these steps:

- 1 Shut down your computer.**
- 2 Insert the floppy disk into the disk drive.**

If you want to initialize, test, or repair your hard disk, use the *Disk Tools* disk to start up your computer. If you want to install system software, use disk 1 from the set of system software disks that came with your computer.

- 3 Turn on the computer.**

## How to initialize a hard disk

You initialize an Apple SCSI hard disk by using a program called Drive Setup, which is on the floppy disk labeled *Disk Tools* that came with your computer. If your computer came with a CD-ROM player and you didn't receive floppy disks, you can find Drive Setup on the CD-ROM disc that contains system software. (To initialize a hard disk from another manufacturer, use the utility software that came with the hard disk.)

- 1 **Start up your computer from the *Disk Tools* disk or the CD-ROM disc that contains system software.**

See “Starting Up From a CD-ROM Disc” or “Starting Up From a Floppy Disk” earlier in this section.

- 2 **Open the Drive Setup icon.**

You may need to look in a folder called Utilities to find Drive Setup.



Drive Setup

- 3 **In the list of drives, click the disk you want to initialize.**

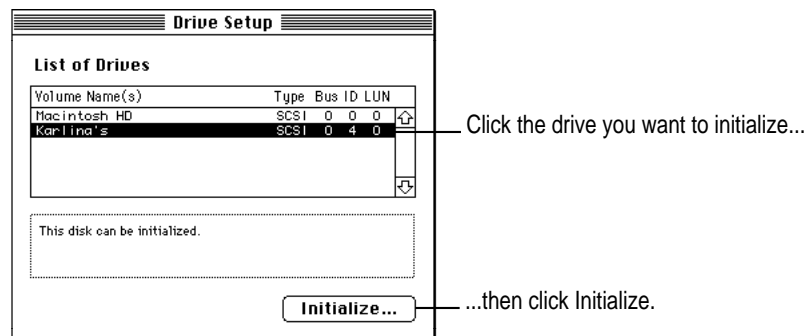

- 4 **Click Initialize to initialize the hard disk.**
- 5 **Click Quit when you see a message reporting that initialization was successful.**

If a message reports that initialization failed, try again. If initialization fails a second time, take the disk to your Apple-authorized service provider for repair.

## Repairing a damaged disk

Disks can become damaged by repeated use and handling.

### When do you need to repair a disk?

If you see a message reporting that a disk is damaged or unreadable, you may need to repair the disk.

### Try these suggestions first

If you can't start up from a hard disk or you don't see the hard disk icon on the desktop, try the following:

- If the hard disk is internal, shut down your Macintosh, wait at least 10 seconds, and then turn it on again.
- If the hard disk is external, make sure that it is turned on and that its cable is connected firmly; then restart the Macintosh.
- If the hard disk is your startup disk, start up with a different startup disk. If the hard disk's icon appears on your desktop, reinstall system software on the hard disk. See "Installing or Reinstalling System Software" later in this chapter.
- Check the ID numbers of all SCSI equipment connected to your computer. Your computer has two SCSI chains, an internal one and an external one. All devices on the same SCSI chain must have unique ID numbers, but devices on different SCSI chains may use the same SCSI ID number. (For example, you can have a CD-ROM player with ID number 3 connected to the internal SCSI chain and a tape drive with ID number 3 connected to the external SCSI chain. You cannot have 2 SCSI devices connected to the external SCSI chain that both use ID number 3.)

On the internal SCSI chain, the computer itself has the ID number 7, and the factory-installed hard disk has the number 0. If your computer came with a CD-ROM player installed, it is also connected to the internal SCSI chain and has ID number 3.

On the external SCSI chain, SCSI devices are numbered either 0 to 6, or 1 to 6 if you have an additional hard drive installed (its number is 0).

Check that both chains of devices are terminated properly. For information on setting SCSI ID numbers and terminating a SCSI chain, see Chapter 3 of this manual and the manuals that came with your SCSI equipment.

- Test the disk following the instructions that come next.

## How to test a hard disk

You can test an Apple SCSI hard disk with the Drive Setup program, which is on the floppy disk labeled *Disk Tools* that came with your computer. If your computer has a built-in CD-ROM player, and you didn't receive floppy disks, you can find the Drive Setup program on the CD-ROM disc that contains system software.

- 1 Start up your computer from the *Disk Tools* disk or the CD-ROM disc that contains system software.**

See “Starting Up From a CD-ROM Disc” or “Starting Up From a Floppy Disk” in the section “Initializing a Hard Disk” earlier in this chapter.

- 2 Open the Drive Setup icon.**

You may need to look in a folder called Utilities to find Drive Setup.



Drive Setup

- 3 In the list of drives, click the disk you want to test.

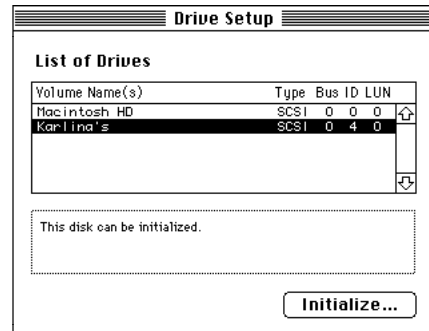

- 4 Pull down the Functions menu and choose Test Disk.
- 5 When a message tells you that testing is complete, click Quit.

If the test reveals a problem, you may be able to correct it by using Disk First Aid or another disk repair program (see the instructions in the next section), or you may need to reinitialize the disk (see “Initializing a Hard Disk” earlier in this chapter). Consult an Apple-authorized service provider for assistance if necessary. If you had a hard disk from another manufacturer installed after you bought your computer, use the software that came with the disk or contact the disk vendor to get the latest version of software.

### How to repair a hard disk or floppy disk

You can repair some types of disk damage by using the Disk First Aid program, which is included either on the *Disk Tools* floppy disk or on the CD-ROM disc containing system software that came with your computer.

- 1 Start up your computer from the *Disk Tools* disk or the CD-ROM disc that contains system software.

See “Starting Up From a CD-ROM Disc” or “Starting Up From a Floppy Disk” in the section “Initializing a Hard Disk” earlier in this chapter.

**2 Open the Disk First Aid icon.**

You may need to look in a folder called Utilities to find Disk First Aid.



Disk First Aid

**3 Click the icon of the disk you want to test.**

Disk icons appear in a box at the top of the Disk First Aid window.

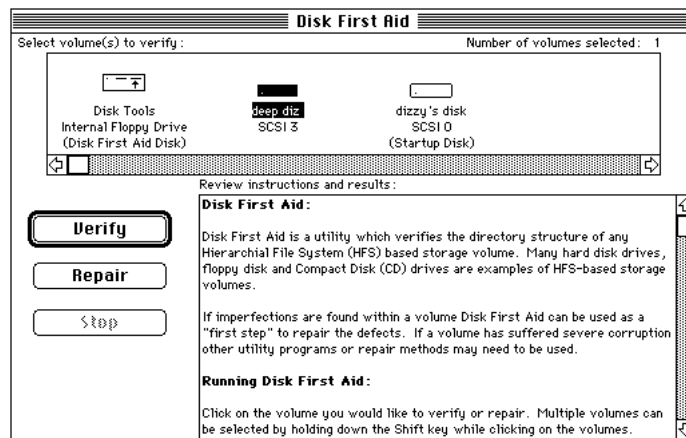

**4 Click Repair to begin testing and repairing the disk.**

You can't repair the startup disk or the disk that contains the Disk First Aid program, but you can test these disks by clicking Verify. If the program reveals a problem with either of these disks, start up the computer from another disk so that you can repair the damaged disk.

If you want to test and repair another disk, click its icon and then click Repair.

**5 When testing and repair are finished, choose Quit from the File menu.**

### If Disk First Aid cannot correct the problem

- Try repairing the disk again. Sometimes repeating the process corrects the problem.
- Use another disk repair or recovery program. Some disk repair programs let you recover information from a damaged disk.
- Consult a computer repair specialist for help.
- Once you have recovered all the information you can, erase (reinitialize) the disk. If initialization doesn't work, discard the damaged disk (if it's a floppy disk), or take it to your Apple-authorized service provider for repair (if it's a hard disk).

## Installing or reinstalling system software

System software is the set of programs and other files that your computer uses to start itself up, keep track of your files, and run the application programs you use. System software is kept in the folder called the System Folder. When you turn on your computer, it looks for a startup disk, which is a disk that contains the system software. The startup disk is usually the hard disk that's inside your computer, though another hard disk or a floppy disk can also be a startup disk.

The accessory kit that came with your Macintosh provides system software on either a set of floppy disks or a CD-ROM disc. You can use the floppy disks or the CD-ROM disc to install the system software on your Macintosh if you need to do so.

### When should you install system software?

Your Macintosh came with all the necessary system software installed on its internal hard disk, so you don't need to install system software on that disk unless you encounter software problems.

If you have a new hard disk or a newly initialized hard disk that doesn't contain system software, or if you want to upgrade to a more recent version of system software on a hard disk, follow the instructions in "Installing System Software" later in this section.

## When should you reinstall system software?

If you have a problem with your system software, you may see this icon in the middle of the screen:



If this icon appears, follow the instructions in “Repairing a Damaged Disk” earlier in this chapter to test your startup hard disk and repair any damage.

If repairing the disk doesn’t help, follow the instructions in the next section, “Installing System Software,” to reinstall system software on your startup hard disk.

## Installing system software

Follow the steps in this section to do what is commonly called a “normal” installation of system software.

If you’re installing system software on a hard disk for the first time, make sure that your hard disk has been initialized, a process that prepares the disk to store information. If you see the hard disk’s icon on the desktop when you start up the computer, the disk has been initialized. If no disk icon appears when you start up, see “Initializing a Hard Disk” earlier in this chapter for instructions.

To do a normal installation, follow these steps:

- 1 Start up your computer from the *Disk Tools* disk or the CD-ROM disc that contains system software.**

See “Starting Up From a CD-ROM Disc” or “Starting Up From a Floppy Disk” in the section “Initializing a Hard Disk” earlier in this chapter.

- 2 Find and open the Disk First Aid icon.**

You may need to look in a folder called Utilities to find Disk First Aid.



Disk First Aid

After Disk First Aid starts, follow the instructions on the screen. Disk First Aid checks your hard disk for any problems.

- 3 When Disk First Aid has finished checking your hard disk, choose Quit from the File menu.
- 4 Open the Drive Setup program.  
You use the Drive Setup program to update your hard disk.
- 5 In the list of drives, click your startup disk.
- 6 Pull down the Functions menu and choose Update Driver.
- 7 When the update process is finished, quit Drive Setup.
- 8 Shut down your computer.
- 9 Start up your computer from disk 1 from your set of system software disks, or from the CD-ROM disc that contains system software.

See “Starting Up From a CD-ROM Disc” or “Starting Up From a Floppy Disk” in the section “Initializing a Hard Disk” earlier in this chapter.

The Installer’s Welcome screen appears. You may have to double-click the System Software Installer icon to open the Installer program.

- 10 Click OK.

The Easy Install dialog box appears.

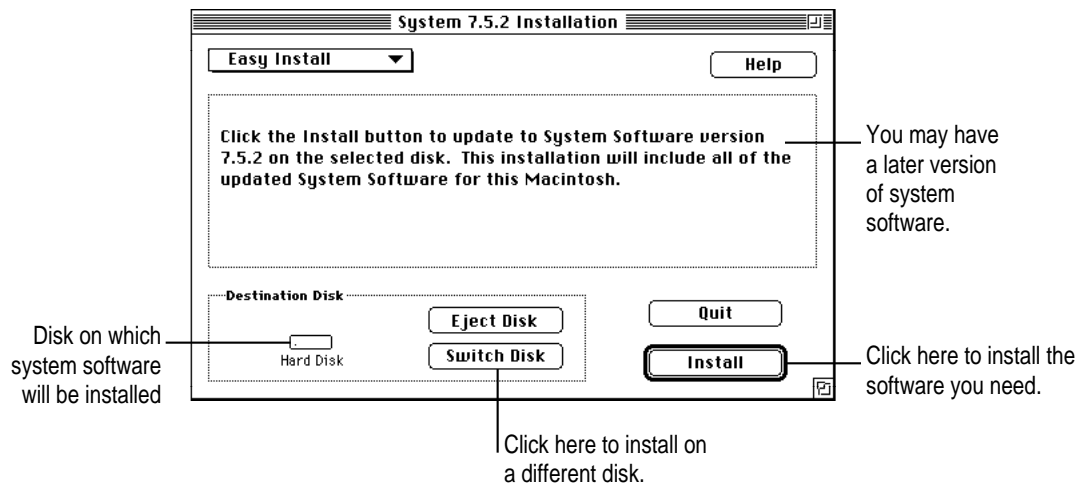

- 11 Make sure that the hard disk named in the box is the one on which you want to install system software.**

If it isn't, click Switch Disk until the correct disk name appears.

- 12 Click Install.**

- 13 Follow the instructions that appear on the screen.**

If you're installing system software from floppy disks, you see messages asking you to insert different disks.

- 14 When you see a message reporting that the installation was successful, click Restart.**

If a message reports that installation was not successful, try installing again. (Follow the instructions on the screen.)

If, after reinstalling system software by doing a normal installation, you still experience problems with your computer, follow the steps in the next section for doing a "clean" installation of system software.

**IMPORTANT** Certain system extensions or application programs that were originally on your hard disk may not be installed with the Installer program. If you notice that a certain extension or program was not installed, you may need to install it separately. You can find these additional extensions and programs on the CD-ROM disc that contains system software. (Application programs from other vendors can be reinstalled from backup copies you made.) If you don't have a CD-ROM player, see the service and support information that came with your computer for information on how to contact Apple directly for assistance.

## Doing a clean installation of system software

The steps in this section outline what is commonly called a “clean” installation of system software. A clean installation allows you to discover which item in your System Folder is causing a problem. A clean installation creates a brand new System Folder and saves everything in your original System Folder in a different location. You can then follow the instructions in “Replacing Special Software,” later in this section, to reinstall system extensions, control panels, and other special software one at a time from the old System Folder to the new System Folder. This procedure allows you to determine which item in the old System Folder was the source of the problem.

Do a clean installation if you can’t determine what is damaged in your System Folder (especially if you think any special software, such as control panels, system extensions, or custom utilities, may be causing the problems you’re experiencing). You should also do a clean installation if you’re still having problems with your computer after you’ve reinstalled system software by doing a normal installation.

To do a clean installation, follow these steps:

- 1 Start up your computer from the *Disk Tools* disk or the CD-ROM disc that contains system software.**

See “Starting Up From a CD-ROM Disc” or “Starting Up From a Floppy Disk” in the section “Initializing a Hard Disk” earlier in this chapter.

- 2 Find and open the Disk First Aid icon.**

You may need to look in a folder called Utilities to find Disk First Aid.



Disk First Aid

After Disk First Aid starts, follow the instructions on the screen. Disk First Aid checks your hard disk for any problems.

- 3 When Disk First Aid has finished checking your hard disk, choose Quit from the File menu.**

**4 Open the Drive Setup program.**

You use the Drive Setup program to update your hard disk.

**5 In the list of drives, click your startup disk.**

**6 Pull down the Functions menu and choose Update Driver.**

**7 When the update process is finished, quit Drive Setup.**

**8 Shut down your computer.**

**9 Start up your computer from disk 1 of the set of system software disks that came with your computer, or from the CD-ROM disc that contains system software.**

See “Starting Up From a CD-ROM Disc” or “Starting Up From a Floppy Disk” in the section “Initializing a Hard Disk” earlier in this chapter.

The Installer’s Welcome screen appears. You may have to double-click the System Software Installer icon to open the Installer program.

**10 Click OK.**

The Easy Install dialog box appears.

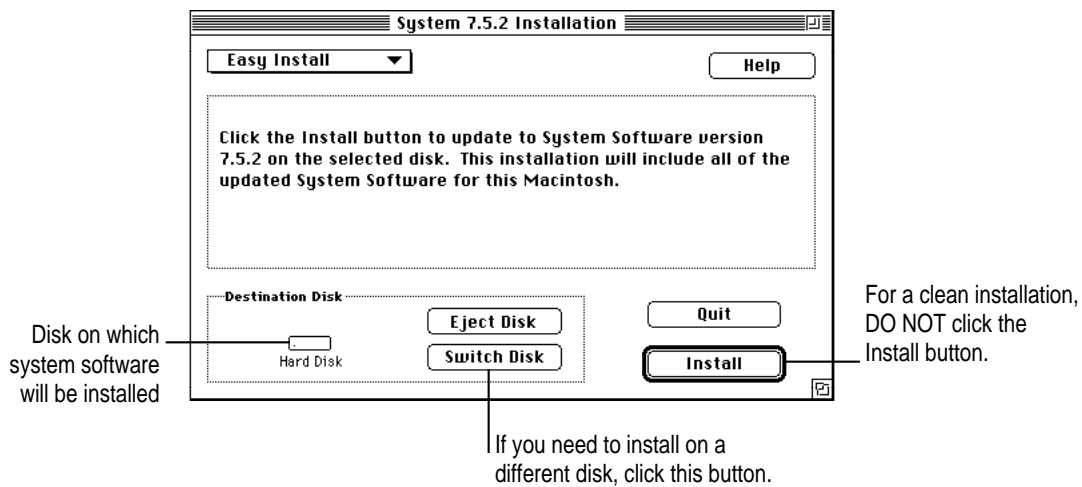

- 11 **Make sure that the hard disk named in the Destination Disk box is the one on which you want to install system software.**

If it isn't, click Switch Disk until the correct disk name appears.

- 12 **Hold down Shift-⌘-K to start the clean installation.**

The following dialog box appears.



- 13 **Click the Install New System Folder button and click OK.**

The Easy Install dialog box appears. The Install button has changed to Clean Install, and the contents of your old System Folder have been moved to a new folder named Previous System Folder.

- 14 **Click Clean Install.**

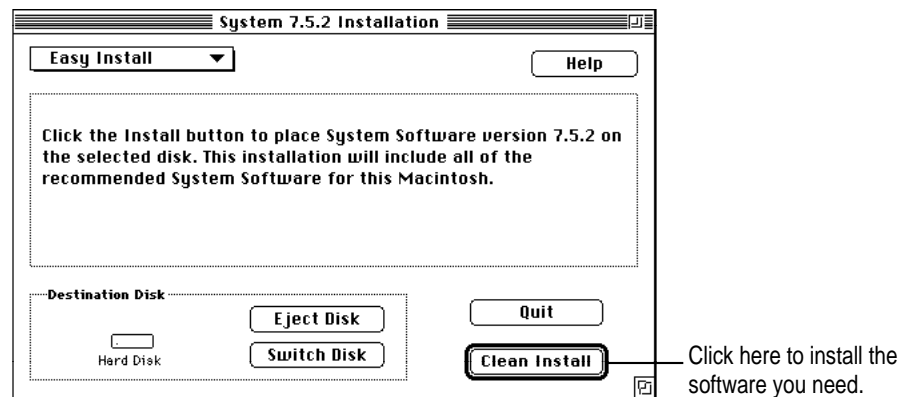

- 15 **Follow the instructions that appear on the screen.**

It takes a few minutes to complete the installation.

- 16 When you see a message reporting that the installation was successful, you may need to click Restart.**

You need to click Restart only if you installed software onto the startup disk.

If a message reports that installation was not successful, try repeating the clean installation procedure.

**IMPORTANT** Certain system extensions or application programs that were originally on your hard disk may not be installed with the Installer program. If you notice that a certain extension or program was not installed, you may need to install it separately. You can find these additional extensions and programs on the CD-ROM disc that contains system software. (Application programs from other vendors can be reinstalled from backup copies you made.) If you don't have a CD-ROM player, see the service and support information that came with your computer for information on how to contact Apple directly for assistance.

### Replacing special software

Special software consists of items such as control panels, system extensions, custom utilities, fonts, or Apple menu items that you may have added to your old System Folder. To make sure that special software does not create any conflicts with other programs on your computer, follow this procedure to safely replace these items in your new System Folder:

- 1 Copy any special software items from the Previous System Folder back to your System Folder one item at a time, restarting the computer after copying each item.**

**IMPORTANT** Be very careful not to *replace* (copy over) any of the files in the System Folder with files from the Previous System Folder.

- 2 Check after each restart to make sure your computer is not having any software problems.**

If any of your special software items cause software problems, contact the software manufacturer for assistance or an upgrade.

## Doing a custom installation

For most Macintosh users, the Easy Install procedure described in the previous sections is appropriate, because it automatically installs all the items you need. However, if you'd like to select a combination of system software files for your specific needs, you can customize your system software installation. You use custom installation to install or update one or more specific files, or to save space on your hard disk by installing only the files you want.

To install customized system software, follow these steps:

- 1 Start up your computer from disk 1 of the set of system software disks that came with your computer, or from the CD-ROM disc that contains system software.**

See “Starting Up From a CD-ROM Disc” or “Starting Up From a Floppy Disk” in the section “Initializing a Hard Disk” earlier in this chapter.

- 2 Click OK.**

The Easy Install dialog box appears.

- 3 Choose Custom Install from the pop-up menu.**



The Custom Install dialog box appears, listing all available system software components.

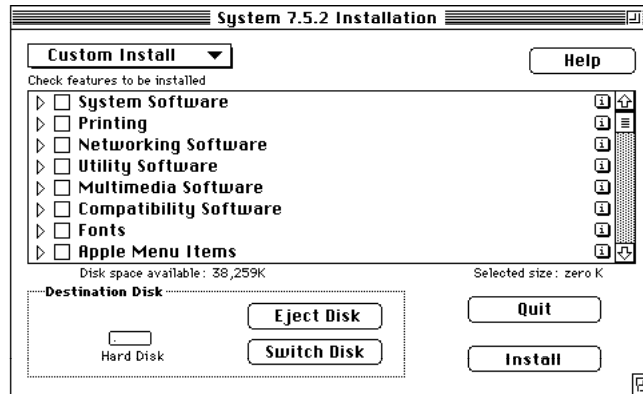

- 4 Scroll through the list of components, clicking the checkbox next to each component you want to install.

You can see and select individual items within each component by clicking the arrow to the left of the component, then clicking the item you want to install. To get additional information about each component listed, click the box with the letter *i* in it to the right of the component.

- 5 Click Install.
- 6 Follow the instructions that appear on the screen.
- 7 When you see a message reporting that the installation was successful, click Quit.

If a message reports that installation was not successful, try installing again. (Follow the instructions on the screen.)

- 8 Restart your Macintosh.

The system software is installed and your computer is ready to use. Don't forget to eject the CD-ROM disc or floppy disk containing system software when you are finished.

## Installing or reinstalling CD-ROM software

CD-ROM software is a set of programs and files that allow your CD-ROM player to work correctly with your computer and allow it to play different kinds of CDs, like Photo CDs or audio CDs. If your computer came with a CD-ROM player installed, the CD-ROM software is part of system software and was pre-installed for you on your computer's hard disk. (It is also available on floppy disks and a CD-ROM disc that came with your Macintosh.)

If you added a CD-ROM player after you bought your computer, the CD-ROM software is probably on floppy disks that came with the player.

### When should you install or reinstall CD-ROM software?

If your Macintosh came with the CD-ROM player already installed, you don't need to install the CD-ROM software unless you encounter problems. (See "Solutions to CD-ROM Problems" earlier in this chapter for descriptions of the kinds of problems you might encounter.)

If you added a CD-ROM player after you bought your computer, you should install the CD-ROM software before you attempt to use the CD-ROM player.

### Reinstalling CD-ROM software

- 1 Start up your computer from disk 1 of the set of system software disks that came with your computer.**

See "Starting Up From a Floppy Disk" in the section "Initializing a Hard Disk" earlier in this chapter.

- 2 Click OK.**

The Easy Install dialog box appears.

- 3 Choose Custom Install from the pop-up menu.**



The Custom Install dialog box appears, listing all available system software components.

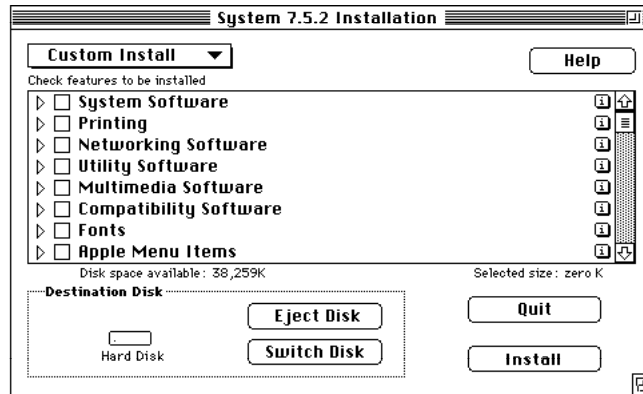

- 4 **Select Multimedia Software by clicking the checkbox next to it.**

To get additional information about each component listed, click the box with the letter *i* in it to the right of the component.

- 5 **Click Install.**

- 6 **Follow the instructions that appear on the screen.**

- 7 **When you see a message reporting that the installation was successful, click Quit.**

If a message reports that installation was not successful, try installing again. (Follow the instructions on the screen.)

- 8 **Restart your Macintosh.**

The CD-ROM software is reinstalled and your computer is ready to use. Don't forget to eject the CD-ROM disc or floppy disk containing system software when you are finished.

**Appendix A** Health, Safety, and Maintenance Tips

**Appendix B** Installing an Expansion Card

**Appendix C** Special Keys on Your Keyboard



# III *part*



Read this appendix for important health and safety instructions, as well as tips on keeping your computer in good working order.



## Appendix A Health, Safety, and Maintenance Tips



For your own safety and that of your equipment, follow all the instructions in this chapter. Keep these instructions available for reference by you and others.

### Health-related information about computer use

Muscle soreness, eye fatigue, and other discomforts and injuries sometimes associated with using computers can occur from performing any number of activities. In fact, misuse of the same muscles during multiple activities can create a problem that might not otherwise exist. For example, if you engage in nonwork activities that involve repetitive stress on the wrist—such as bicycling—and also use your computer’s keyboard improperly, you may increase your likelihood of developing wrist problems. Some individuals are at greater risk of developing these problems because of their health, physiology, lifestyle, and general exposure to stress. Work organization and conditions, such as workstation setup and lighting, also play a part in your overall health and comfort. Preventing health problems is a multifaceted task that requires careful attention to the way you use your body every hour of every day.

The most common health effects associated with using a computer are musculoskeletal discomfort and eye fatigue. We’ll discuss each area of concern.

## Musculoskeletal discomfort

As with any activity that involves sitting for long periods of time, using a computer can make your muscles sore and stiff. To minimize these effects, set up your work environment carefully, using the guidelines that follow, and take frequent breaks to rest tired muscles. To make working with your computer more comfortable, allow enough space in your work area so that you can change position frequently and maintain a relaxed posture.

Another type of musculoskeletal concern is repetitive stress injuries (RSIs), also known as cumulative trauma disorders (CTDs). These problems can occur when a certain muscle or tendon is repeatedly overused and forced into an unnatural position. The exact causes of RSIs are not totally understood, but in addition to awkward posture, such factors as the amount of repetition, the force used in the activity, the individual's physiology, workplace stress level, and lifestyle may affect the likelihood of experiencing an RSI.

RSIs did not suddenly arise when computers were invented; tennis elbow and writer's cramp, for example, are two RSIs that have been with us for a long time. Although less common than other RSIs, one serious RSI discussed more often today is a wrist problem called carpal tunnel syndrome, which may be aggravated by improper use of computer keyboards. This nerve disorder results from excessive pressure on the median nerve as it passes through the wrist to the hand.

This section offers advice on setting up your work area to enhance your comfort while you use your computer. Since the effects of repetitive movements associated with using a computer can be compounded by those of other work and leisure activities to produce or aggravate physical problems, proper use of your computer system must be considered as just one element of a healthy lifestyle.

No one, of course, can guarantee that you won't have problems even when you follow the most expert advice on using computer equipment. You should always check with a qualified health specialist if muscle, joint, or eye problems occur.

## Eye fatigue

Eye fatigue can occur whenever the eyes are focused on a nearby object for a long time. This problem occurs because the eye muscles must work harder to view an object that's closer than about 20 feet (6 meters). Improper lighting can hasten the development of eye fatigue. Although eye fatigue is annoying, there's no evidence that it leads to permanent damage.

Whenever you're engaged in an activity that involves close-up work—such as reading a magazine, doing craft work, or using a computer—be sure to have sufficient glare-free lighting and give your eyes frequent rest breaks by looking up and focusing on distant objects. Remember to have your eyes examined regularly.

To prevent discomfort and eye fatigue:

- Arrange your work space so that the furniture is properly adjusted for you and doesn't contribute to an awkward working posture.
- Take frequent short breaks to give your muscles and eyes a chance to rest.

## Arranging your office

Here are some guidelines for adjusting the furniture in your office to accommodate your physical size and shape.

- An adjustable chair that provides firm, comfortable support is best. Adjust the height of the chair so your thighs are horizontal and your feet flat on the floor.

The back of the chair should support your lower back (lumbar region). Follow the manufacturer's instructions for adjusting the backrest to fit your body properly.

- When you use the computer keyboard, your shoulders should be relaxed. Your upper arm and forearm should form an approximate right angle, with your wrist and hand in roughly a straight line.

You may have to raise your chair so your forearms and hands are at the proper angle to the keyboard. If this makes it impossible to rest your feet flat on the floor, you can use a footrest with adjustable height and tilt to make up for any gap between the floor and your feet. Or you may lower the desktop to eliminate the need for a footrest. Another option is to use a desk with a keyboard tray that's lower than the regular work surface.

- Position the mouse at the same height as your keyboard. Allow adequate space to use the mouse comfortably.
- Arrange the monitor so the top of the screen is slightly below your eye level when you're sitting at the keyboard. The best distance from your eyes to the screen is up to you, although most people seem to prefer 18 to 28 inches (45 to 70 cm).
- Position the monitor to minimize glare and reflections on the screen from overhead lights and windows. You may want to use a tiltable monitor stand. The stand lets you set the monitor at the best angle for viewing, helping to reduce or eliminate glare from lighting sources you can't move.

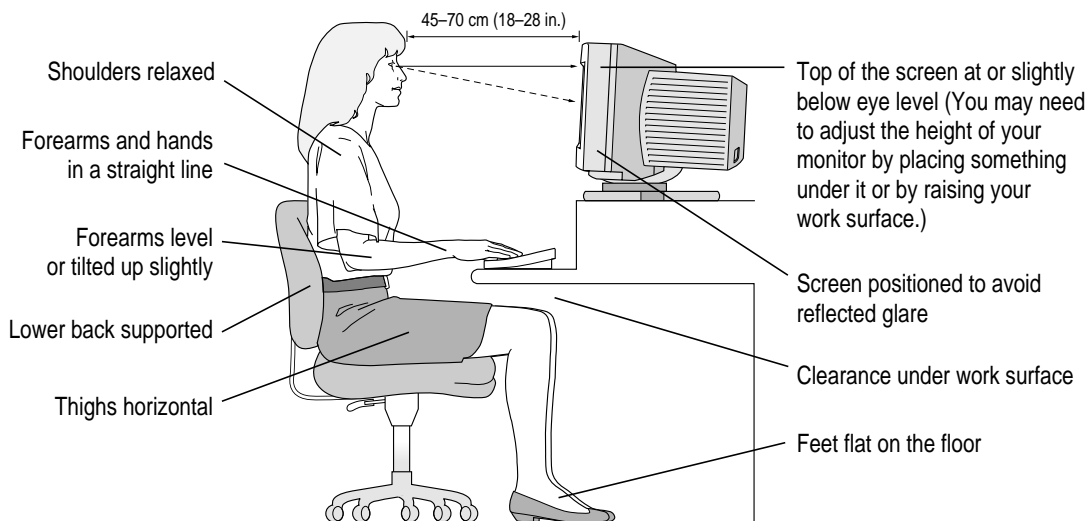

## Avoiding fatigue

- Change your seated position, stand up, or stretch whenever you start to feel tired. Frequent short breaks are helpful in reducing fatigue.
- Use a light touch when typing or using a mouse and keep your hands and fingers relaxed.
- Some computer users may develop discomfort in their hands, wrists, or arms after intensive work without breaks. If you begin to develop chronic pain or discomfort in your hands, wrists, or arms, consult a qualified health specialist.
- Allow adequate work space so that you can use your keyboard and mouse comfortably. Place papers or other items so you can view them easily while using your computer. A document stand may make reading papers more comfortable.
- Eye muscles must work harder to focus on nearby objects. Occasionally focus your eyes on a distant object, and blink often while you work.
- Clean your screen regularly. Keeping the screen clean helps reduce unwanted reflections.

## What about electromagnetic emissions?

There has been recent public discussion of the possible health effects of prolonged exposure to extremely low frequency (ELF) and very low frequency (VLF) electromagnetic fields. Such fields are associated with electromagnetic sources such as television sets, electrical wiring, and some household appliances—as well as computer monitors.

Apple has reviewed scientific reports and sought the counsel of government regulatory agencies and respected health organizations. Based on the prevailing evidence and opinions, Apple believes that the electric and magnetic fields produced by computer monitors do not pose a health risk.

In response to those customers who wish to reduce their exposure to electromagnetic fields, Apple has lowered the emission levels of our products. We are also actively encouraging further scientific research so we can continue to promote the health and safety of our customers and employees.



## Safety instructions

For your own safety and that of your equipment, always take the following precautions.

Turn off the computer completely and disconnect the power plug (by pulling the plug, not the cord) if any of the following conditions exists:

- the power cord or plug becomes frayed or otherwise damaged
- you spill something into the case
- your Macintosh is exposed to rain or any other excess moisture
- your Macintosh has been dropped or the case has been otherwise damaged
- you suspect that your Macintosh needs service or repair
- you want to clean the case (use only the recommended procedure described later in this chapter)

Be sure that you always do the following:

- Keep your Macintosh away from sources of liquids, such as wash basins, bathtubs, shower stalls, and so on.
- Protect your Macintosh from dampness or wet weather, such as rain, snow, and so on.
- Read all the installation instructions carefully before you plug your Macintosh into a wall socket.
- Keep these instructions handy for reference by you and others.
- Follow all instructions and warnings dealing with your system.

**WARNING** Electrical equipment may be hazardous if misused. Operation of this product, or similar products, must always be supervised by an adult. Do not allow children access to the interior of any electrical product and do not permit them to handle any cables.

## Handling your computer equipment

Follow these guidelines for handling your computer and its components:

- When setting up your computer, place components on a sturdy, flat surface, and carefully follow all setup instructions.
- When connecting or disconnecting a cable, always hold the cable by its connector (the plug, not the cord).
- Turn off your computer and all its components before connecting or disconnecting any cables to add or remove any component. Failure to do so could seriously damage your equipment.
- Never force a connector into a port. If the connector and port do not join with reasonable ease, they probably don't match. Make sure that the connector matches the port and that you have positioned the connector correctly in relation to the port.
- Take care not to spill any food or liquid on the computer, keyboard, mouse, or other components. If you do, turn your computer off immediately and unplug it before cleaning up the spill. Depending on what you spilled and how much of it got into your equipment, you may have to bring your equipment to an Apple-authorized service provider.
- Protect the computer and its components from direct sunlight and rain or other moisture.
- Keep all ventilation openings clear and unobstructed. Without proper air circulation, components can overheat, causing damage or unreliable operation.

**WARNING** This equipment is intended to be electrically grounded. Your Macintosh is equipped with a three-wire grounding plug—a plug that has a third (grounding) pin. This plug will fit only a grounded AC outlet. This is a safety feature. If you are unable to insert the plug into the outlet, contact a licensed electrician to replace the outlet with a properly grounded outlet. Do not defeat the purpose of the grounding plug!

## Handling the monitor

Follow these procedures for handling a monitor:

- Turn down the screen brightness control if you leave the computer turned on for extended periods. If the brightness is not turned down, the image on the screen could “burn in” and damage the screen.

You can also use a “screen saver” program, which dims or varies the image on the screen when the computer has been idle for a specified period of time. These programs are available from independent suppliers and user groups.

- Make sure that the ventilation openings on the computer and the monitor are clear and unobstructed.
- Some large monitors cannot safely be placed on top of the computer. Check the instructions that came with the monitor for setup information.
- If there is interference on the monitor’s screen or on a television or radio near your computer, move the affected equipment farther away.

## Handling the keyboard

Take care not to spill any liquid on the keyboard. If you do, turn off your computer immediately.

- If you spill liquid that is thin and clear, unplug the keyboard, turn it upside down to let the liquid drain out, and let it dry for 24 hours at room temperature. If, after you take these steps, the keyboard doesn’t work, take it to an Apple-authorized service provider for repair.
- If you spill liquid that is greasy, sweet, or sticky, unplug the keyboard and take it to an Apple-authorized service provider for repair.

## Handling floppy disks

Store disks at temperatures between 50° F and 125° F.

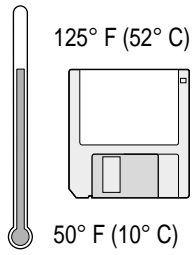

Do not use a pencil or an eraser on a disk or disk label.

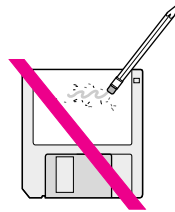

Keep disks dry.

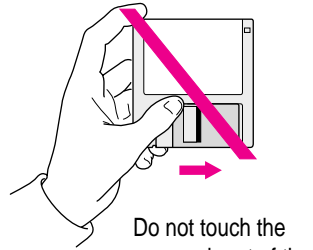
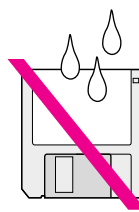

Do not touch the exposed part of the disk behind the metal shutter.

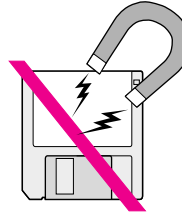

Keep disks away from magnets.

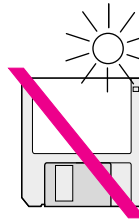

Avoid exposing disks to extremely hot temperatures.

## Handling CD-ROM discs

Keep these important safety instructions in mind as you use CD-ROM discs:

- Hold a disc by the edges or by one edge and the center hole. Do not touch the disc surface.
- To clean discs, wipe the shiny surface with a soft damp cloth, working in straight lines from center to edge. Do not use any form of cleaning agent.
- To avoid damage to your discs, keep these points in mind:

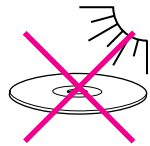

Do not expose discs to direct sunlight.

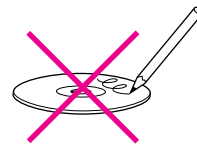

Do not write on discs.

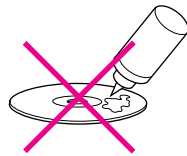

Do not spill liquids on discs.

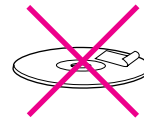

Do not put tape on discs.

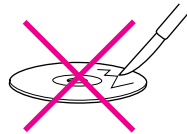

Do not scratch discs.



Do not get dust on discs.

Other important safety instructions to keep in mind as you use your CD-ROM player:

- Position your computer so that when the tray opens, it doesn't bump into anything.
- Do not leave the disc tray open. If dust gets on the lens of the CD-ROM player, the player may have problems reading your compact discs.
- Do not put anything (for instance, a cup) on top of the tray when it is open.
- Do not force the tray open by hand.
- Do not wipe the lens with a paper towel or other abrasive surface. If you need to clean the lens, see an Apple-authorized service provider for a lens cleaner.
- Never transport your computer with a disc inside the CD-ROM player.
- Keep your computer equipment away from any source of liquid (such as wash basins, bathtubs, and shower stalls). If you drink coffee or other beverages while you're at your computer, take care not to spill.
- Avoid exposing your equipment to damp or wet weather. If your system is near a window, be sure the window is closed in rainy weather.

The tray on your CD-ROM player automatically closes when you shut down your computer. You may want to open the tray and take out your CD-ROM disc before shutting down.



## Ejecting a floppy disk

For instructions on ejecting a floppy disk or a removable media disk, see the “Disks” topic of Macintosh Guide, available in the Guide (📖) menu.

## If you can't eject a floppy disk

If you can't eject a floppy disk in the usual way, try the following in order:

- Hold down the ⌘ and Shift keys and press the number 1 key on your keyboard to eject a disk in the internal disk drive.
- Turn off the computer. If the disk isn't ejected, then hold down the button on your mouse or other pointing device while you turn the computer on again.
- Locate the small hole near the disk drive's opening, and carefully insert the end of a large straightened paper clip into it. Push gently until the disk is ejected. Do not use excessive force.

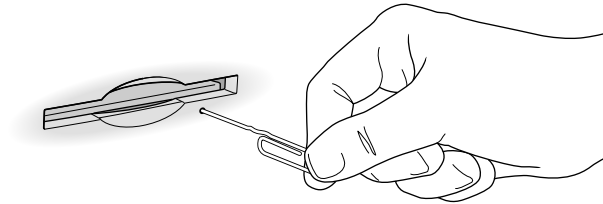

If nothing works, take the computer or disk drive to your Apple-authorized service provider to have the disk removed.

## Power supply

The power supply in your computer is a high-voltage component and should not be opened for any reason, even when the computer is off. If the power supply needs service, contact your Apple-authorized dealer or service provider.

## Cleaning your equipment

Follow these general rules when cleaning the outside of your computer and its components:

- Use a damp, soft, lint-free cloth to clean the computer's exterior. Avoid getting moisture in any openings.
- Don't use aerosol sprays, solvents, or abrasives.

### Cleaning the computer case

To clean the case, do the following:

- 1 Turn off the computer completely and then disconnect the power plug. (Pull the plug, not the cord.)
- 2 Wipe the surfaces lightly with a clean, soft cloth dampened with water.

### Cleaning the monitor

To clean the screen, put household glass cleaner on a soft cloth and wipe the screen. Don't spray the cleaner directly on the screen, because the liquid might drip into the monitor or computer.

### Cleaning the mouse

The mouse contains a small ball that must roll smoothly for the mouse to work properly. You can keep this ball free of dirt and grease by using the mouse on a clean, lint-free surface and cleaning it occasionally.

You need a few cotton swabs and a clean, soft, lint-free cloth.

- 1 Turn off your computer.

- 2 Turn the mouse upside-down and turn the plastic ring on the bottom counterclockwise to disengage it.

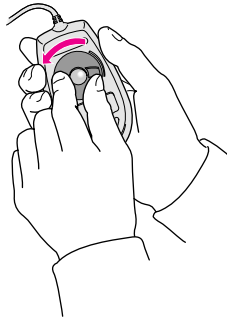

If you have an older mouse, you may need to press the plastic ring (rather than turn it) to disengage it.

If the mouse is locked, see the next section, “Locking and Unlocking the Mouse,” for instructions on how to unlock it.

- 3 Turn the mouse right-side up with one hand and catch the ring and the ball with your other hand.
- 4 Clean the three small rollers inside the mouse with a cotton swab moistened with water. Rotate the rollers to clean all around them.

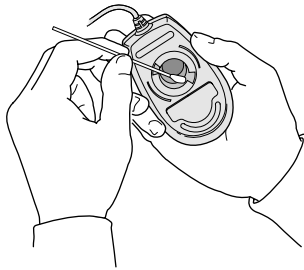

- 5** Wipe the mouse ball with a clean, soft, dry, and lint-free cloth.
- 6** If necessary, wash the mouse ball with warm soapy water (use a mild soap such as a dishwashing liquid) and then dry the mouse ball thoroughly.
- 7** Gently blow into the mouse case to remove any dust that has collected there.
- 8** Put the ball and the ring back in place.

Your mouse should roll smoothly across your mouse pad or desk. If it doesn't, repeat these instructions carefully.



## Locking and unlocking the mouse

Some mouse devices can be locked so that the ball can't be removed. A locking mouse has a small hole on the plastic ring.

To lock the mouse, follow these steps:

- 1 Insert a straightened paper clip into the hole on the plastic ring.**

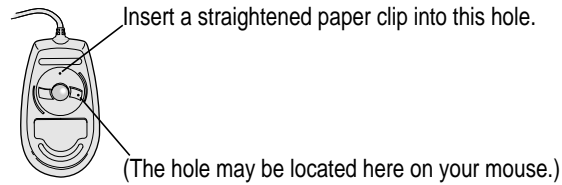

- 2 Press down on the paper clip while you turn the ring clockwise.**

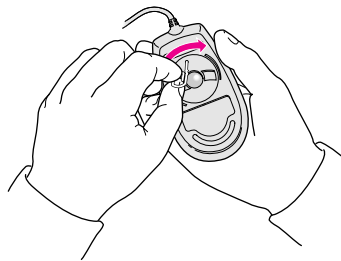

Turn the ring a very short distance, until it stops. When the recessed area on the ring is not lined up with the recessed area surrounding the ring, the mouse is locked.

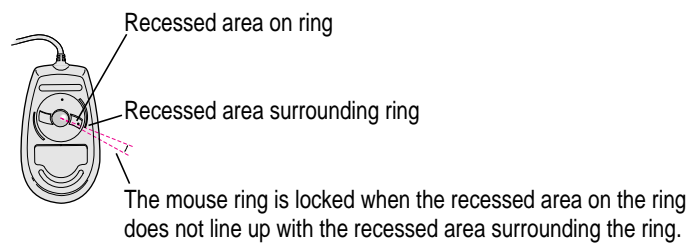

To unlock the mouse, follow these steps:

- 1** Insert a straightened paper clip into the hole on the plastic ring.

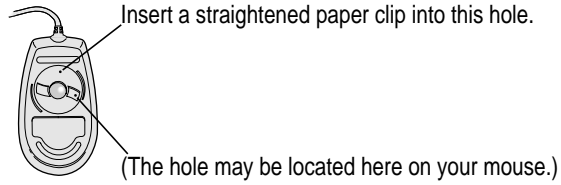

- 2** Press down on the paper clip while you turn the ring counterclockwise.

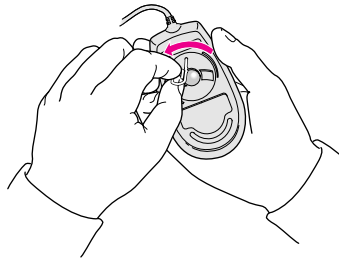

Turn the ring a very short distance. When the recessed area on the ring is lined up with the recessed area surrounding the ring, the mouse is unlocked.

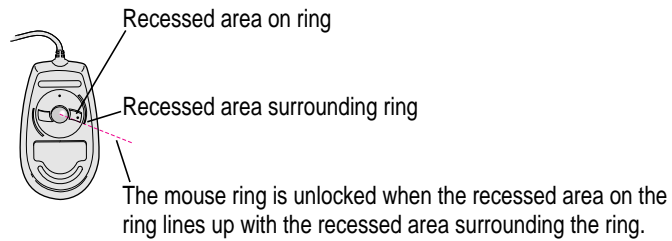



Read this appendix for instructions  
on installing an expansion card  
in your computer.



## Appendix B Installing an Expansion Card

• • • • •

You can install printed circuit boards (called *cards*) for video and graphics applications, networking and communications, additional processing power, or other purposes. The cards fit into *expansion slots* inside the computer.

Your Macintosh has six expansion slots, each designed to accept a Peripheral Component Interconnect (PCI) card. There is also an expansion slot that contains the computer's processor card. (The processor card can be upgraded by replacing it with a more powerful processor card.)

**WARNING** If an expansion card requires an adapter, be sure to use the adapter card designed specifically for your model of the computer. Failure to do so could damage the card and your computer.

**IMPORTANT** Some cards may need to be installed by an Apple-authorized service provider. Check the information that came with the card.

## Expansion card power requirements

The combined power consumption of expansion cards must not exceed the limits specified for your Macintosh model. If you have more than one expansion card installed, check the information that came with your cards to make sure that their power consumption is within the limits specified in the *Technical Information* booklet.

## Installing an expansion card

**IMPORTANT** Some cards may need to be installed by an Apple-authorized service provider. Check the information that came with the card.

**1 Turn off the computer.**

Leave the computer plugged in to ground it.

**2 Loosen the six large screws at the corners and sides of the back panel.**

Do not completely remove the screws or the back panel.

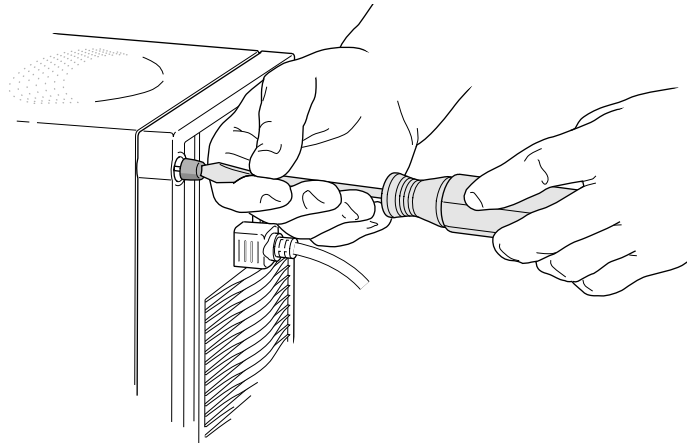

**3 Remove the cover from the computer.**

Slide the cover away from the back panel an inch or two. Then raise the cover straight up and off the computer.

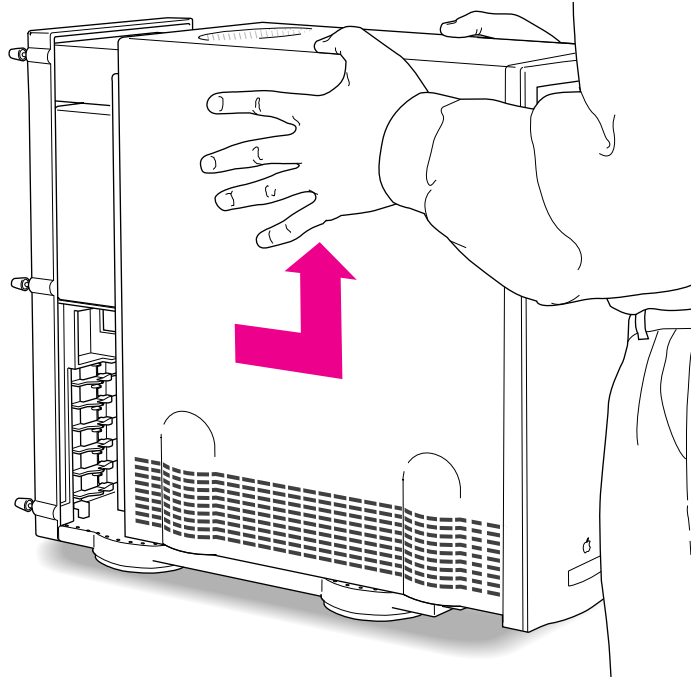

- 4 **Touch the metal part of the power supply case inside the computer to discharge static electricity.**

Always do this before you touch any parts, or install any components, inside the computer.

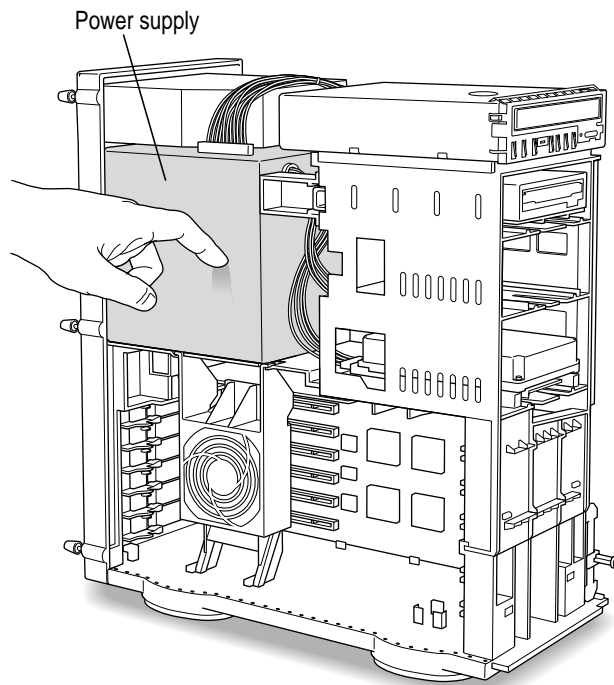

**5 Lower the auxiliary fan.**

Squeeze the sides of the fan and pull down.

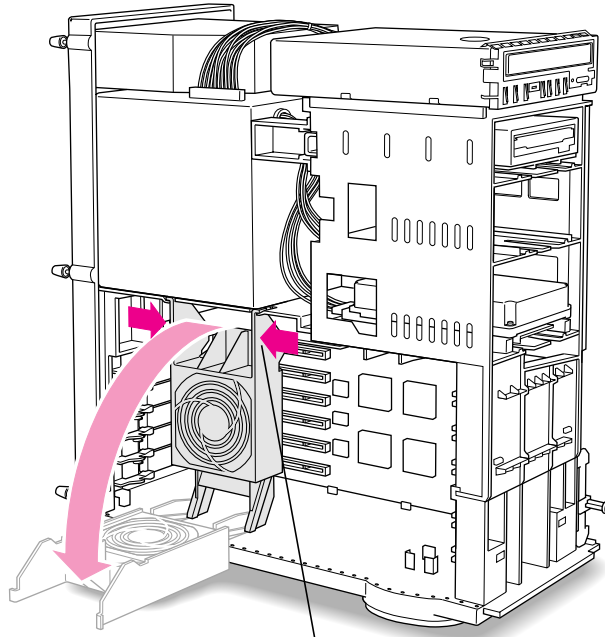

To lower the auxiliary fan, squeeze the sides to unlatch it.

- 6** Being careful not to touch the sharp edges, pull out the metal access port cover behind the expansion slot you want to use, and set the access port cover aside.

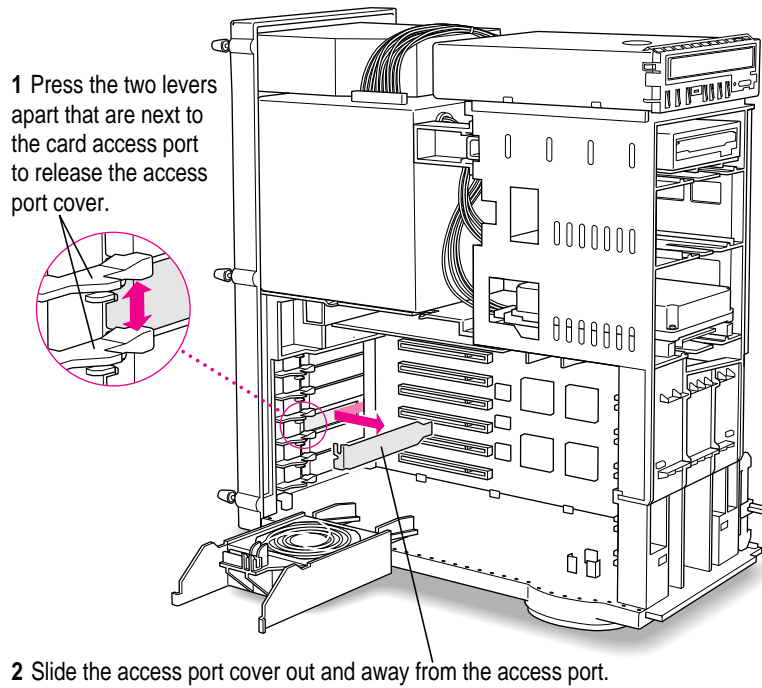

- 7** Remove the card from its static-proof bag.

Hold the card by its edges to avoid touching the connector.

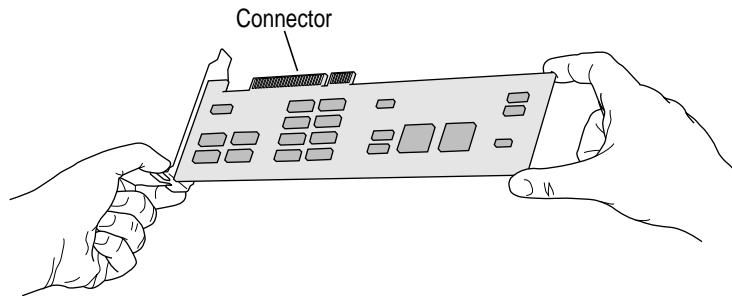

**8** Align the connector end of the card with the expansion slot.

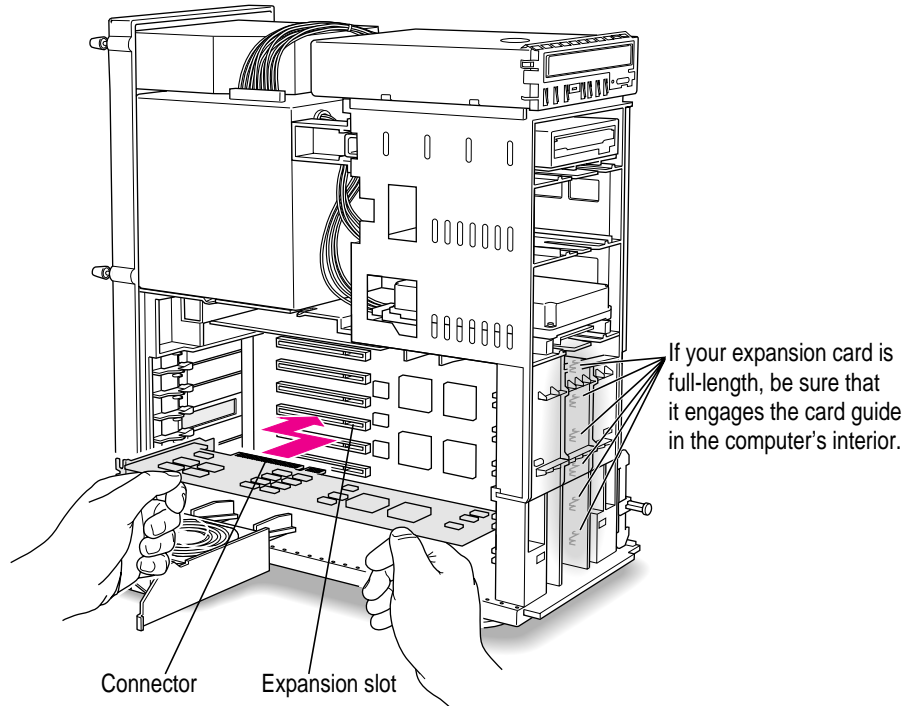

**9** Press the card gently but firmly until the connector is fully inserted.

- Slide the card between the two levers that held the access port cover you removed earlier. You may need to press the levers apart slightly to guide the card between them.
- Don't force the card. If you meet a lot of resistance, pull the card out and try again.
- To see if the card is properly connected, pull it gently. If it resists and stays in place, it's connected. (Make sure you don't pull the card so much that you accidentally disconnect it.)

If you have other cards to install, put them in now by repeating steps 6 through 9.

**10** Lift the auxiliary fan back into place.

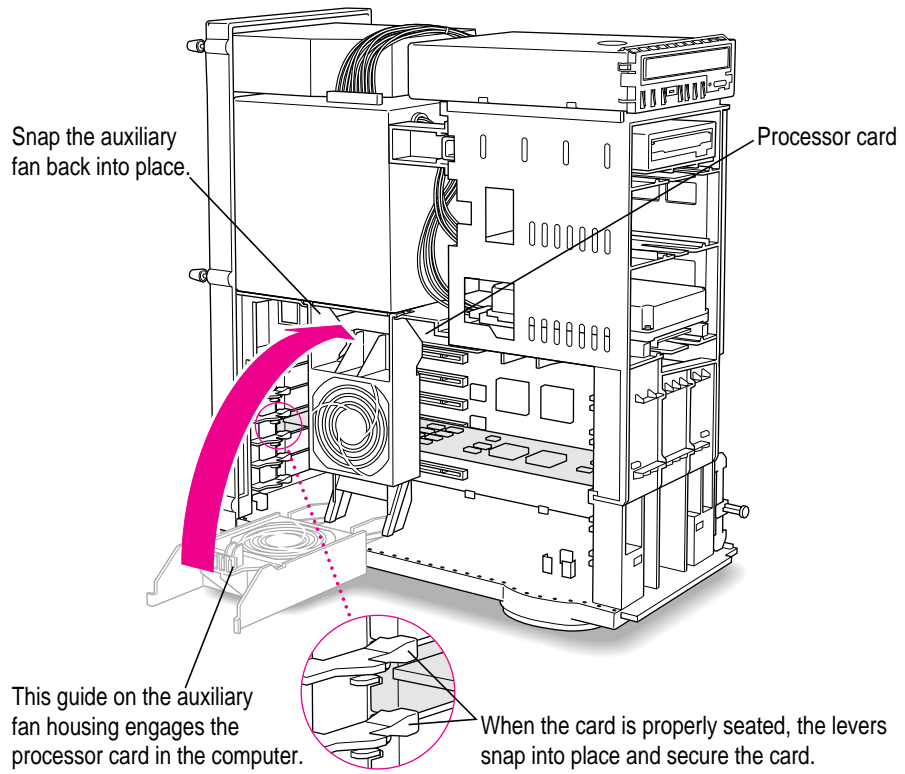

**11 Replace the cover on the computer.**

Lower the cover all the way down onto the case. Push the cover back until it touches the back panel.

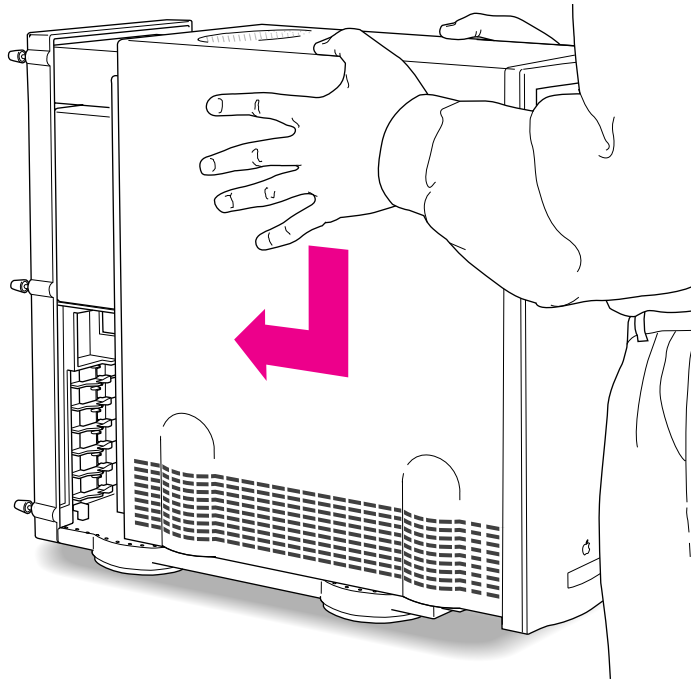

**12 Tighten the screws on the back panel.**

You are now finished installing the card. You may turn on the computer and start using the new card.

**WARNING** Always replace the cover before turning the computer on.

## Upgrading the processor

Your computer's processor can be upgraded with the installation of a processor upgrade card.

To upgrade your processor, remove the old processor card, then follow the procedure in this chapter for installing expansion cards to install the new processor card. (Note that you do not need to remove the access port cover as described in step 6.)

Refer to the documentation that came with the processor upgrade card for instructions specific to the card.

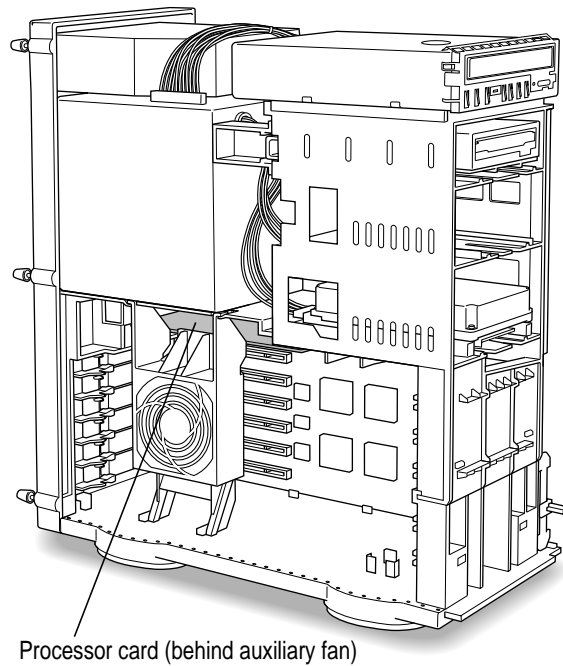

Read this appendix to learn how to use the special keys on your keyboard.

## Appendix C Special Keys on Your Keyboard

Your computer keyboard contains certain special keys that typewriter keyboards don't have. Many of these keys allow you to give commands to the computer without using the mouse. For example, in many application programs, you can press the ⌘ (Command) key at the same time as the Q key to quit a program.

The following table describes what you can do with the special keys on your keyboard. The special keys on your keyboard depend on the model of keyboard you have; some keyboards do not have all the keys listed here.

### Special keys on Apple keyboards

#### Arrow keys

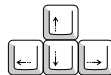

Use to move the insertion point, as an alternative to using the pointer. In some programs, the arrow keys have other functions.

#### Caps Lock key



Use to capitalize a series of letters (numbers and symbols aren't affected).

#### Clear key



Use to delete the current selection (or use the Delete key). In some programs, Clear has other functions.

#### ⌘ (Command) key



Use in combination with other keys as an alternative to choosing a menu command.

*continued* ▶

## Special keys on Apple keyboards *(continued)*

### Control key



In combination with other keys, this key provides shortcuts or modifies other actions.

### Delete key



Use to delete selected material, or the character to the left of the insertion point.

### Enter key



In a dialog box, pressing Enter is the same as clicking the outlined button. In some programs, pressing this key confirms information you have provided.

### Escape key



The function of this key depends on the program you're using.

### Function keys



Some programs allow you to use the 12 function keys to give commands. You can assign commands or action sequences to function keys with special utility programs.

### Option key



Use in combination with other keys to produce special characters or modify actions.

### Numeric keys



Use to produce numbers and mathematical symbols; some programs use these keys as function keys to initiate actions.

### Power key



On some models, press to turn on the computer. Also press to shut down the computer on certain models.

### Return key



Use to move the insertion point to the beginning of the next line. In a dialog box, pressing Return is the same as clicking the outlined button.

### Shift key



Use to produce capital letters (or the upper character on the key).

### Tab key



Use to move the insertion point to the next stopping place (such as a tab stop or field in a dialog box or program).

### Other special keys



The function of these keys depends on the operating system and program you're using.

## Typing special characters and symbols

You can type a variety of international and other special symbols and characters (including characters with diacritical marks, such as accents) by pressing combinations of keys.

The Key Caps program, which is installed with your system software, shows you the characters produced when you type certain keys and key combinations in the fonts available on your computer. Choose Key Caps from the Apple (🍏) menu, then choose the font from the Key Caps menu.

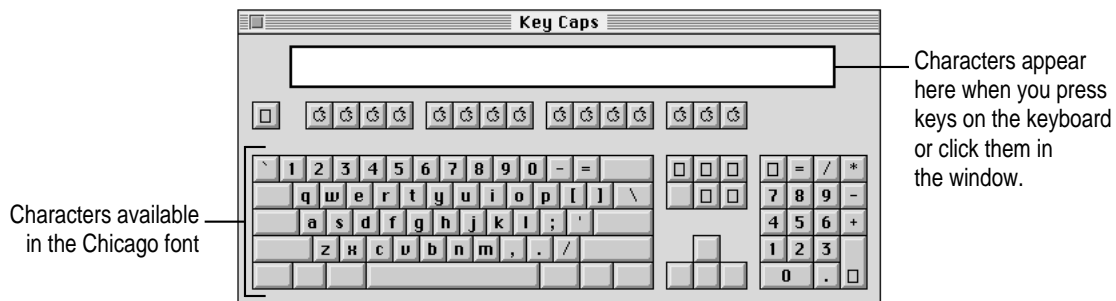

To have Key Caps show more options for special characters, press each of these keys or key combinations: Option, Shift, Shift-Option, Shift-⌘, and Option-⌘.

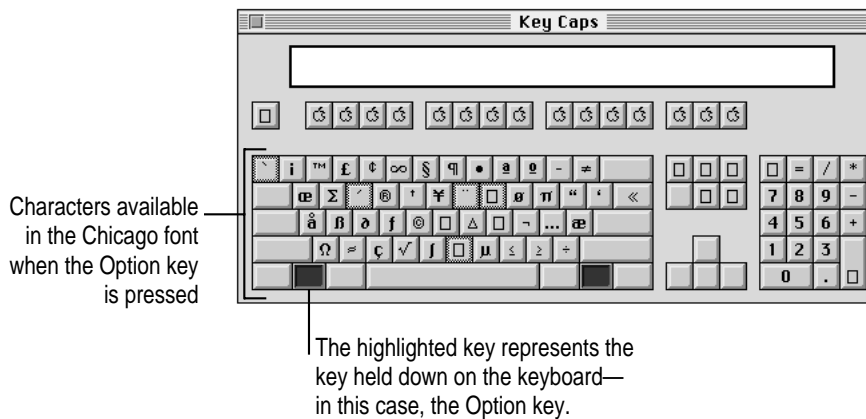

If you press the Option key, Key Caps outlines lightly the keys that you can use in combination with letter keys to type letters with accents or other diacritical marks.

*If you see rectangles:* If you see rectangles instead of diacritical marks on some of the pictures of keys in Key Caps, try pressing Option-⌘ to see the diacritical marks. However, you only need to use the Option key (not Option-⌘) in combination with the other keys to type letters with diacritical marks.

If you press the Option key at the same time as a key for a specific diacritical mark and then release both keys, Key Caps outlines in bold the keys for letters that can be typed with that mark. (You'll see that most key combinations for diacritical marks can be used with the Space bar as well as letter keys—producing the mark without a letter.)

The most common diacritical marks and how to create them are summarized next.

Diacritical mark	Key combination
Grave accent ( ` )	Option-`, then type the character
Acute accent ( ´ )	Option-e, then type the character
Circumflex ( ^ )	Option-i, then type the character
Tilde ( ~ )	Option-n, then type the character
Umlaut ( ¨ )	Option-u, then type the character
The letter "c" with a cedilla ( ç )	Option-c

- **To type a letter or a space with a specific diacritical mark, press the Option key and the key for the mark simultaneously. Then type the letter that needs the mark.**

If you are having trouble getting a mark and letter to appear together, try again. Be sure to press the Option key before (or at the same time as) the key for the mark; then, after you release both keys, type the letter to be marked.

## Special key combinations

If difficulties with your mouse or computer don't allow you to use standard methods of quitting a program or restarting your computer, you can try using these special key combinations.

To do this...	...press this key combination
Force a program to quit	⌘-Option-Esc
Force the computer to restart	⌘-Control-Power key

Here are other key combinations you may find useful.

To do this...	...press this key combination
Start a "debugging" application used by software programmers*	⌘-Power key
Start the computer from a CD-ROM disc	C key (at startup)
Rebuild desktop	Shift key (while starting up) release, then hold Option-⌘

\*If you do not have a debugging program installed, your screen displays a caret prompt (>). To return to the desktop, type "G."



If you can't find what you're looking for in this index, look in Macintosh Guide—available in the Guide (🔍) menu on your computer.



## Index

• • • • •

### A

- AAUI network, connecting to 45
- accent marks, typing 141–142
- access covers for expansion slots 35, 134
- active program 16, 49, 50
- acute accent (´), typing 142
- adapter for expansion card 129
- ADB port. *See* Apple Desktop Bus (ADB) port
- America Online, obtaining Apple software updates 89
- amplifier, connecting 37–38
- Apple-authorized service providers, contacting. *See also* troubleshooting
  - attaching devices to the internal SCSI interface 40
  - connecting additional equipment 33
  - disk initialization failure 92, 97
  - installing additional DRAM 44
  - installing expansion cards 129, 130
  - interference with radio and television reception vi
  - lens cleaner for CD-ROM lens 121
  - liquid or other spills on computer equipment 117, 118
  - pointer doesn't move when you move the mouse 74
  - problems ejecting a floppy disk 70, 122
  - problems opening tray of CD-ROM player 79
  - problems starting up the computer 67
  - reinstalling system extensions or application programs 100, 104
  - removing built-in terminators 42
  - repair service 62, 75
  - replacing the clock battery 65
  - servicing the power supply 122
- AppleCD Audio Player 56, 82
- Apple Desktop Bus (ADB) port 8, 9, 35, 74
- Apple Extensions Manager 49
- Apple Extras folder
  - application programs contained in 47
  - as a source of help 19
- AppleLink software updates, obtaining 86
- Apple (🍏) menu, Key Caps program 141–142
- Apple PlainTalk Microphone 2. *See also* microphone
- AppleScript program 47
- Apple software updates, obtaining 86–89
- AppleTalk control panel 45–46

- Application menu
  - Hide Others/Show All commands 50
  - using 16
  - working with several programs at a time 49–50
- application programs
  - backing up 48
  - can't be found 75
  - can't be opened 76
  - compatibility issues with older Macintosh programs 77
  - icons for 17
  - included with your computer 47
  - installing and using 48–50
  - opening/saving documents with different file formats 76
  - Power Macintosh “native” applications 51–52
  - reinstalling 72, 100, 104
  - won't start or quit unexpectedly 71–72
- arrow keys 139
- arrow pointer on screen
  - moving 14–15
  - what to do if it “freezes” 61, 63, 73–74
- At Ease 71, 78
- Audio CD Access CD-ROM
  - extension 80
- audio CDs 56, 82
- audio equipment, connecting 36–40
- auxiliary fan 133, 136

## B

- backing up
  - application programs 48
  - files and disks 51
- Balloon Help 30
- battery in clock, replacing 65
- blinking question mark icon 66, 98
- “bomb” message/icon on screen 61, 63, 72, 83
- brightness control 13, 64, 118
- BOOTP bootstrapping protocol 46

## C

- cables
  - audio equipment 37, 82
  - Ethernet 45
  - external stereo speaker 39
  - keyboard 2, 8, 9, 73, 74
  - monitor 2, 7, 65
  - mouse 8, 9, 73
  - network 45
  - printer 85
  - safe handling of 117
  - SCSI peripheral interface 42
  - SCSI system 41
- Caps Lock key 139
- cards. *See* expansion cards
- carpal tunnel syndrome 112
- cartridge backup drives, connecting 40–43
- CD-ROM discs. *See also* CD-ROM system software disc
  - cleaning 120
  - ejecting 55
  - guidelines for handling 120
  - icon doesn't appear on desktop 80
  - inserting 48, 54
  - problems with 80–81
  - sharing over a network 58
  - starting up from 91, 143
  - storage capacity of 53
  - using ISO 9660 or High Sierra discs 81
- CD-ROM drive/player
  - connecting 40–43
  - icon doesn't appear on screen 77
  - illustration 34
  - installing 44
  - installing software for 107–108
  - opening/closing 54, 55, 79
  - overview 53
  - playing audio CDs 56, 82
  - problems using 77–79
  - safety instructions vii, 121
  - software installation problems 70, 77, 78, 80
  - working with Photo CDs 57

- CD-ROM system software disc, starting up from
  - basic instructions 91
  - installing system software 99, 102, 105
  - for troubleshooting 66, 67, 68, 70, 80
  - to use Disk First Aid 95, 98, 101
  - to use Drive Setup 90, 94
- cedilla (ç), typing 142
- chains, SCSI 40, 42, 43
- chair, adjusting for computer use 113, 114
- Chooser, printer settings 85
- circumflex (^), typing 142
- C key (at startup) to start from a CD-ROM disc 143
- cleaning computer equipment 120, 123–125
- clean installation of system software 101–104
- Clear key 139
- clock in computer keeps time inaccurately 65
- close box 17
  - in Macintosh Guide window 28, 29
- ⌘-Control-Power key to restart the computer 63
- ⌘ key 139
- ⌘-Option-Esc to quit a program 63, 73, 143
- ⌘-Option-p-r to reset PRAM 65
- ⌘-Power key to start a debugging application 143
- ⌘-Shift-1 keys to eject a floppy disk 70
- compatibility issues with system
  - extensions or control panels 72, 73, 84
- CompuServe, obtaining Apple software updates 87
- computer case, cleaning 123
- computer equipment. *See* equipment
  - connecting. *See also* installing
    - audio equipment 36–40
    - computer 3
    - external stereo speakers 39–40
    - keyboard 8–9
    - microphone 38–39
    - monitor 4–7
    - mouse 8–9
    - SCSI devices 40–43
    - to a network 45–46
  - Control key 140
  - control panels
    - AppleTalk 45–46
    - Extensions Manager 72, 73
    - Memory 71, 77
    - Monitors 65
    - PC Exchange 75, 76
    - performance problems and 84
    - Sharing Setup 55
    - TCP/IP 45–46
    - turning off 72, 73, 74
  - cumulative trauma disorders (CTDs) 112
  - customer support hotline 19. *See also* Apple-authorized service providers
  - custom installation of system software 105–106
  - Custom Install dialog box 106, 108
  - custom utilities, performance problems and 84

## D

- dampness, protecting the computer from 116, 117, 121
- DAT drive, installing 44
- Delete key 140
- desktop
  - At Ease 71, 78
  - hard disk icon doesn't appear 68
  - hiding/showing windows on 50
  - looks unusual 71, 78
  - rebuilding 64, 68, 75, 143
- device drivers for SCSI devices, installing 41
- diacritical marks, typing 141–142
- DIMMs 44
- disconnecting power to the computer 4
- Disk First Aid program 95–97, 98–99, 101
- disk repair/recovery programs 97
- Disk Tools* disk, starting up from
  - basic instructions 91
  - for troubleshooting 66, 67, 68, 70, 78
  - to use Disk First Aid 98, 101
  - to use Drive Setup 90, 94, 95
- documents. *See also* files
  - can't open 75, 76, 81
  - icons for 17
- DOS disks, using in the Macintosh 69
- DOS documents, problems opening on the Macintosh 75, 76
- DRAM Dual Inline Memory Modules (DIMMs) 44
- Drive Setup program
  - initializing a hard disk 90, 92
  - making a hard disk available 68
  - overview 47
  - testing a hard disk 94–95
  - updating a hard disk 99, 102
- dual-plug adapter 39
- dynamic random-access memory (DRAM), expanding 44

## E

- Easy Access 74
- Easy Install dialog box 99, 102, 103
- ejecting
  - CD-ROM discs 55
  - floppy disks, problems with 122
- electromagnetic emissions, health effects of exposure to 115
- Empty Trash command (Special menu) 17
- Enter key 140
- equipment
  - arranging and adjusting for optimal use 112, 113–114
  - cleaning 123–125
  - guidelines for handling 117–121
  - illustration 2, 34–35
  - safety precautions 116
- error messages. *See under* troubleshooting
- Escape key 140
- Ethernet cables 45
- Ethernet network 45
  - connecting to 45–46
- Ethernet ports (AAUI, 10BASE-T) 34, 35
- expansion cards
  - installing 4, 129–137
  - power requirements 130
- expansion slots 129, 135
  - access covers for 35, 134
- Extensions Manager control panel 72, 73
- external stereo speakers, connecting 39–40
- eye fatigue associated with computer use 111, 113, 115

## F

- fatigue from computer use, avoiding 113, 115
- FDDI networks 45
- files. *See also* documents
  - backing up 51
- file sharing
  - ejecting CD-ROM discs and 55
  - sharing a CD-ROM disc 58
- Finder
  - activating 22, 29
  - icon 49
- floating-point unit (FPU)
  - requirements 72
- floppy disk drive
  - illustration 34
  - installing (internal) 44
- floppy disks
  - backing up 51
  - can't eject 70
  - can't start up from 67
  - ejecting 122
  - format/density issues 69
  - guidelines for handling 119
  - repairing 95–97
  - starting up from 91
  - unreadable 69
- folders
  - Apple Extras 19, 47–48, 68
  - icons for 17
  - Previous System Folder 103, 104
  - System Folder 49, 52, 84, 97, 101–104
  - Utilities 68, 92, 94, 96, 98, 101
- Foreign File Access CD-ROM
  - extension 80
- formatting a hard disk 90–92
- Function keys 140
- furniture for computer use, arranging 113–114

## G

- graphics, Photo CD images as a source for 57
- grave accent (`), typing 142
- grounding the computer 3, 117
- Guide (⌘) menu. *See also* Macintosh Guide
  - displaying 15, 16, 22
  - Hide Balloons command 30
  - Shortcuts command 31–32
  - Show Balloons command 30

## H

- hard disk
  - backing up 51
  - icon 12, 17
  - icon does not appear on the desktop 68, 90, 93
  - initializing 90–92
  - making available 68
  - repairing 93, 95–97
  - testing 94–95
  - updating 99, 102
- hard disk drive
  - connecting 40–43
  - illustration 34
  - installing (internal) 44
- hard disk space, using as memory 51
- health-related information about computer use 111–115
- help. *See* Apple-authorized service providers; Balloon Help; customer support hotline; Guide (⌘) menu; Macintosh Guide; troubleshooting
- Hide Balloons command (Guide [⌘] menu) 30
- Hide Others command (Application menu) 50
- hiding/showing windows on the desktop 50
- High Sierra CD-ROM discs 81
- “Huh?” button, Macintosh Guide window 29

## I, J

### icons

- ADB 8, 9
  - application program 17
  - blinking question mark 66, 98
  - defined 17
  - Disk First Aid 96, 98, 101
  - disk with an X 67
  - document 17
  - do not appear correctly on screen 68
  - Finder 49
  - folder 17
  - hard disk 12, 17
  - ports 34–35
  - “sad Macintosh” 67
  - SCSI 40
  - Trash 17
- Index button, Macintosh Guide 23, 25–26
- initializing a hard disk 90–92
- inserting a CD-ROM disc 48
- Installer program
- clean installation of system software 101–104
  - custom installation of system software 105–106
  - installing CD-ROM software 70, 78, 107–108
  - normal installation of system software 99–100
- installing. *See also* connecting
- additional DRAM 44
  - CD-ROM software 107–108
  - device drivers for SCSI devices 41
  - expansion card 4, 129–137
  - internal storage devices 44
  - monitor card 4
  - processor upgrade card 138
  - system extensions 100, 104
  - system software 97–106

interference with radio and television reception vi, 118

international characters and symbols, typing 141–142

### Internet

- configuring your system for 45–46
  - ISDN networks 45
  - obtaining Apple software updates 88–89
- ISO 9660 CD-ROM discs 81

## K

### keyboard

- connecting 8–9
  - correct posture for using 113–114
  - guidelines for handling 118
  - illustration 2, 34
  - ports 8, 9
  - typing produces nothing on screen 74
- keyboard cable
- checking connections 73, 74
  - illustration 2
  - plugging in 8, 9
- keyboard shortcuts 31–32
- keyboard tray 114
- Key Caps program (Apple [⌘] menu) 141–142
- key combinations
- for common diacritical marks 142
  - for special functions 143

## L

- LaserWriter Select 300 model, printer driver compatibility 85
- liquid spills on computer equipment 116, 117, 118, 121
- LocalTalk network, connecting to 45
- locking the mouse 126
- Look For button, Macintosh Guide 23, 27–28

## M

- Macintosh Easy Open 49
- Macintosh Guide. *See also* Guide (🔍) menu
  - activating 22
  - closing 28, 29
  - Index button 23, 25–26
  - Look For button 23, 27–28
  - moving the window out of the way 29
  - returning to main window 24, 26, 29
  - tips for using 29
  - Topics button 23–24
- Macintosh Tutorial 14–15
- memory
  - allocating more 71
  - DRAM 44
  - expanding 44
  - “not enough memory” message 71–72
  - PRAM 65
  - using hard disk space as 51
  - virtual memory 71
  - VRAM 44
- Memory control panel 71, 77
- memory requirements for Power Macintosh applications 51
- menu bar 16
- menus 15, 16
- microphone
  - connecting 38–39
  - illustration 2, 34
- modem port (GeoPort) 34, 35
- Modern Memory Manager, turning off 77
- moisture, protecting the computer from 116, 117, 121
- monitor
  - brightness control 13, 64, 118
  - cleaning the screen 115, 123
  - guidelines for handling 118
  - illustration 2, 34
  - placement and position of 5, 114
  - turning on 12
- monitor cable 2, 7, 73
- monitor card 4
- monitor port 7, 34, 35
- monitor power cord 5–6
- monitor power cord socket 6, 35
- Monitors control panel 65
- mouse
  - cleaning 123–125
  - connecting 8–9
  - how to use 14–15
  - illustration 2, 34
  - locking/unlocking 126–127
  - problems with 73–74
- mouse button 14, 15
- mouse cable 8, 9, 73
- mouse ports 8, 9
- mouse shortcuts 31–32
- musculoskeletal discomfort associated with computer use 111, 112

## N

- network cables 45
- networks
  - connecting to 45–46
  - sharing a CD-ROM disc and 58
- normal installation of system software 98–101
- “not enough memory” message 52
- Numeric keys 140

## O

- Option-⌘ keys to rebuild the desktop 64, 68, 143
- Option key 140
  - combined with other keys for typing diacritical marks 142

## P

- Parameter RAM (PRAM), resetting 65
- PC Exchange control panel 69, 75, 76
- performance issues 84
- Peripheral Component Interconnect (PCI) cards 45, 129
- Personal LaserWriter LS and 300 models, printer driver compatibility 85
- Photo CDs 57, 83
- plugging in the computer 3
- pointer. *See* arrow pointer on screen ports
  - Apple Desktop Bus (ADB) 8, 9, 35, 74
  - Ethernet (AAUI) 34, 35
  - Ethernet (10BASE-T) 34, 35
  - joining connectors to 117
  - keyboard 8, 9
  - modem (GeoPort) 34, 35
  - monitor 7, 34, 35
  - mouse 8, 9
  - printer (GeoPort) 34, 35
  - SCSI 34, 35, 40
  - security lock 35
  - sound input/output 35–39
- power button 18, 34, 63
- power cords
  - checking connections 65
  - connecting the monitor 5–6
  - disconnecting the computer's cord 4
  - illustration 2, 3
- power cord sockets 3, 6, 35

## Power key

- illustration 11, 34, 140
  - restarting the computer 63
  - turning on the computer 11, 18, 34, 140
- Power Macintosh “native” application programs 51–52
- Power-on light 34
- PowerPC microprocessor ix
- power supply 122, 132
- power switch on monitor 12
- PowerTalk program 47
- precautions. *See* safety instructions
- Previous System Folder 103, 104
- printer driver compatibility issues 85
- printer port (GeoPort) 34, 35
- printers
  - connecting 40–43
  - problems with 85
- problems. *See* troubleshooting
- processor upgrade card, installing 138
- programs. *See* application programs *and* names of specific programs

## Q

- QuickDraw GX program 47

## R

- radio and television reception, interference with vi, 118
- RAM. *See* memory
- Read Me file 19
- rebuilding the desktop 64, 68, 75, 143
- Reduced Instruction Set Computing (RISC) technology ix
- reinstalling
  - CD-ROM software 107–108
  - system software 97–106

- repairing disks 93–97
- repetitive stress injuries (RSIs) 112
- replacing special software in new System Folder 104
- replacing the clock battery 65
- Restart command (Special menu) 63
- restarting the computer
  - methods for 63, 143
  - troubleshooting and 66–67, 70–73, 75, 78, 80
- Return key 140

## S

- “sad Macintosh” icon 67
- safety instructions
  - CD-ROM discs 120
  - CD-ROM drive/player vii, 121
  - cleaning equipment 120, 123–125
  - connecting a SCSI or ADB device 33
  - floppy disks 119
  - general precautions 116
  - handling equipment 117–118
  - installing additional DRAM 44
- scanners, connecting 40–43
- screen. *See also* monitor
  - appears dark 64
  - cleaning 115, 123
  - minimizing glare and reflections 114, 115
- screen saver programs 64, 118
- scroll arrows 17
- scroll bar, Macintosh Guide Index window 25
- SCSI chains 40, 42, 43
- SCSI devices
  - computer doesn’t recognize 66
  - connecting 40–43
- SCSI ID numbers 41, 66, 68, 77, 93
- SCSI interface (internal) 40
- SCSI peripheral interface cable 42
- SCSI port 34, 35, 40
- SCSI system cable 41
- SCSI terminators 42
- security lock ports 35
- shared libraries for Power Macintosh applications 52, 76
- Sharing Setup control panel 55
- Shift key 140
- Shortcuts command (Guide [⌘] menu) 31–32
- Show All command (Application menu) 50
- Show Balloons command (Guide [⌘] menu) 30
- showing/hiding windows on the desktop 50
- Shut Down command (Special menu) 18, 71, 78
- size box 17
- sleep mode 64
- slider, Macintosh Guide Index window 25
- software license agreement 86
- software updates, obtaining 86–89
- sound input/output ports 35–39
- special characters and symbols, typing 141–142
- special keys 140, 143
- Special menu
  - Empty Trash command 17
  - Restart command 63
  - Shut Down command 18, 71, 78
- spills on computer equipment 116, 117, 118, 121
- startup disk, defined 97
- static electricity, discharging 132
- stereo miniplug 37, 39
- stereo speakers, connecting 39–40
- StyleWriter and StyleWriter II models, printer driver compatibility 85
- switching to another program 50
- symbols and international characters, typing 141–142

- system extensions
  - performance problems and 84
  - reinstalling 100, 104
  - turning off
    - before installing application programs 49
    - to rebuild the desktop 68, 75
    - to resolve software problems 70, 72, 73, 78
- System Folder
  - creating a new one 101–104
  - decreased performance and 84
  - discarding extras 49
  - replacing special software items 104
  - shared libraries and 52
  - system software and 97
- system software
  - installing/reinstalling 97–106
  - problems starting up the computer 66
- System software floppy disks, starting up from
  - basic instructions 91
  - installing CD-ROM software 107
  - installing system software 99, 102, 107

## T

- Tab key 140
- tape backup drives, connecting 40–43
- tape recorder, connecting 37–38
- TCP/IP control panel 45–46
- television and radio reception,
  - interference with vi, 118
- temperature ranges for storing floppy disks 119
- 10BASE-T network, connecting to 45
- terminators for SCSI chains 42
- testing a hard disk 94–95
- text box, Macintosh Guide Look For window 27
- Text-to-speech program 47
- tilde (~), typing 142
- title bar, Macintosh Guide window 29

- TokenRing networks 45
- Topics button
  - Macintosh Guide 23–24, 26, 29
  - Macintosh Shortcuts 31–32
- Trash, dragging items to 17
- troubleshooting. *See also* Apple-
  - authorized service providers
  - arrow pointer “freezes” on screen 61, 63, 73–74
  - audio CD problems 82
  - CD-ROM disc problems 80–81
  - CD-ROM player problems 77–79
  - computer’s clock keeps time inaccurately 65
  - diagnosing problems 62–63
  - error messages
    - “application program can’t be found” 75
    - “application program can’t be opened because a file can’t be found” 76
    - blinking question mark icon 66, 98
    - “bomb” message/icon on screen 61, 63, 72, 83
    - “Could not create a socket” 46
    - “not enough memory” message 52, 71
    - resolving 61, 62
    - “This is not a Macintosh disk: Do you want to initialize it?” 80
    - “Unable to locate host” 46
- floppy disks
  - can’t eject 70, 122
  - can’t read 69
  - can’t start up from 67
  - format/density issues 69
  - repairing 95–97
- hard disk
  - icon does not appear 68
  - repairing 93–97
- icons
  - CD-ROM disc icon doesn’t appear on desktop 80
  - do not appear correctly on screen 68

- network configuration problems 46
- Photo CD problems 83
- printer problems 85
- restarting the computer
  - can't restart after installing software for CD-ROM player 70, 78
  - can't restart with CD-ROM disc inside the player 71, 79
  - using ⌘-Control-Power key to restart 63
- screen is dark 64
- starting up
  - computer can't find system software to start up 66
  - computer doesn't recognize SCSI equipment 66
  - disk with an X appears on screen 67
  - "sad Macintosh" icon appears 67
  - turning on the computer 13
  - unusual desktop appears after computer starts up 71, 78
  - system is "frozen" 61, 63, 73, 83
  - system software problems 66
- working with programs
  - application won't start or quits unexpectedly 71–72
  - can't open a DOS document on the Macintosh 75, 76
  - compatibility issues with older Macintosh programs 77
  - performance problems 84
  - typing produces nothing on screen 74–75
  - using ⌘-Option-Esc to quit a program 63
- turning off Easy Access 74
- turning off system extensions. *See* system extensions
- turning off the computer 18, 34, 116, 117, 140

- turning on the computer 11, 13, 18, 34, 140
- turning on the monitor 12
- tutorial, starting the Macintosh Tutorial 14–15
- typing produces nothing on screen 74

## U

- umlaut (¨), typing 142
- unlocking the mouse 127
- updated Apple software, obtaining 86–89
- updating the hard disk 99, 102
- Utilities folder
  - Disk First Aid program 96, 98, 101
  - Drive Setup program 68, 92, 94

## V

- ventilation for computer equipment 117, 118
- video RAM (VRAM), expanding 44
- viewing PhotoCD images 57
- virtual memory 71
- virus-protection programs 49
- volume control of external speakers 40

## W, X, Y

- warranty on computer 44
- windows, viewing and moving 17
- work space, arranging 113–114

## Z

- zoom box, Macintosh Guide window 29



Apple Computer, Inc.

1 Infinite Loop

Cupertino, California 95014-2084

408.996.1010

030-8760-A

Printed in U.S.A.