



# **Administrator's Guide**

*for the Workgroup Server 6150/66*

 Apple Computer, Inc.

© 1995 Apple Computer, Inc. All rights reserved.

Under the copyright laws, this manual may not be copied, in whole or in part, without the written consent of Apple. Your rights to the software are governed by the accompanying software license agreement.

The Apple logo is a trademark of Apple Computer, Inc., registered in the United States and other countries. Use of the “keyboard” Apple logo (Option-Shift-K) for commercial purposes without the prior written consent of Apple may constitute trademark infringement and unfair competition in violation of federal and state laws.

Every effort has been made to ensure that the information in this manual is accurate. Apple is not responsible for printing or clerical errors.

Apple Computer, Inc.  
1 Infinite Loop  
Cupertino, CA 95014-2084  
(408) 996-1010

Apple, the Apple logo, AppleShare, AppleTalk, EtherTalk, LaserWriter, LocalTalk, Macintosh, PlainTalk, and StyleWriter are trademarks of Apple Computer, Inc., registered in the United States and other countries.

AppleCD, Apple Desktop Bus, AppleScript, AppleSearch, AudioVision, Balloon Help, Disk First Aid, Finder, GeoPort, Mac, Macintosh PC Exchange, Power Macintosh, PowerTalk, QuickDraw, and QuickTime are trademarks of Apple Computer, Inc.

Adobe, Adobe Illustrator, and PostScript are trademarks of Adobe Systems Incorporated, which may be registered in certain jurisdictions.

Creo is a registered trademark of Creo Systems Inc.

Helvetica and Times are registered trademarks of Linotype Company.

IBM is a registered trademark of International Business Machines Corporation.

Microsoft is a registered trademark, and Windows is a trademark, of Microsoft Corporation.

Motorola is a registered trademark of Motorola Corporation.

NuBus is a trademark of Texas Instruments.

PowerPC is a trademark of International Business Machines Corporation, used under license therefrom.

QuarkXPress is a registered trademark of Quark, Inc.

Simultaneously published in the United States and Canada.

Mention of third-party products is for informational purposes only and constitutes neither an endorsement nor a recommendation. Apple assumes no responsibility with regard to the performance or use of these products.

# Contents

*Communications regulation information / viii*

*Laser information / ix*

## **Preface About This Guide / xi**

### **1 Setting Up Your Server / 1**

Your server at a glance / 2

Security issues / 3

    Physically isolating the system / 4

    Using a locking cable / 4

Installing an expansion card / 5

Connecting a monitor / 5

    Connecting the monitor's power cord / 5

    Connecting the monitor cable / 7

Connecting the mouse and keyboard / 8

Connecting other devices / 9

Plugging in the server / 9

Turning the server on / 10

    Problems turning on your server? / 12

Setting the system time and date / 12

Turning the server off / 13

---

## **2 Connecting to the Network / 15**

- Connecting to an Ethernet network / 16
  - Connecting to thin coaxial Ethernet / 17
  - Connecting to twisted-pair Ethernet / 18
  - Connecting to other types of Ethernet / 19
- Connecting to a LocalTalk network / 20
- If you need to switch the network connection / 22

## **3 Expanding Your Server and Connecting Other Equipment / 25**

- Installing an expansion card / 26
  - Installing the card / 27
- Expanding memory / 34
- Installing other internal devices / 34
- Connecting hard disks and other SCSI devices / 34
  - Setting the SCSI ID number / 35
  - Connecting a SCSI device / 37
  - Installing a device driver / 38
  - Do you need to initialize a hard disk? / 39
- Connecting a printer / 40
- Connecting an additional monitor / 40
- Connecting a trackball or other input device / 40
- Connecting a microphone / 41
- Connecting a GeoPort Telecom Adapter or modem / 42

## **4 Using Software With Your Server / 43**

Using Power Macintosh programs / 44

    Virtual memory / 44

    Shared libraries / 44

Using older Macintosh programs / 45

Using server application programs / 46

    Setting the system time and date / 46

    Order of installing and starting programs / 46

    Setting up your server to restart programs automatically / 47

Additional capabilities for your server system / 48

Backing up your files / 48

## **5 Troubleshooting / 49**

When you run into trouble / 49

    Take your time / 49

    Start over / 50

Solutions to common problems / 51

When you need to reinstall system software / 60

    Reinstalling system software / 60

    Creating startup floppy disks / 64

What to do if your server's performance decreases / 65

    Doing a clean installation of system software / 66

If there's a problem with your CD-ROM drive software / 69

Repairing a damaged disk / 70

    Try these suggestions first / 70

    How to test a hard disk / 71

    How to repair a hard disk or floppy disk / 72

    If Disk First Aid cannot correct the problem / 73

## **Appendix A Safety, Maintenance, and Health Information / 75**

- Important server safety instructions / 75
- Handling your computer equipment / 77
  - Handling the monitor / 78
  - Handling the keyboard / 78
  - Handling floppy disks / 79
  - Ejecting a disk / 79
  - If you can't eject a floppy disk / 79
  - Power supply / 80
- Cleaning your equipment / 80
  - Cleaning the server case / 80
  - Cleaning the monitor / 81
  - Cleaning the mouse / 81
- Health-related information about computer use / 82
  - Musculoskeletal discomfort / 83
  - Eye fatigue / 84
  - Arranging your office / 84
  - Avoiding fatigue / 86
  - What about electromagnetic emissions? / 86

## **Appendix B Getting Help / 87**

- Learning the basics / 88
- Reviewing the basics / 89
- Getting answers in Macintosh Guide / 90
  - Getting answers with the Topics button / 92
  - Getting answers with the Index button / 93
  - Getting answers with the Look For button / 95
  - Tips for using Macintosh Guide / 97
- Identifying objects on the screen / 98
- Learning useful shortcuts / 99

**Appendix C Special Keys on Your Keyboard / 101**

**Appendix D Using Stereo Audio / 103**

About your server's sound ports / 104

Connecting an audio device / 105

    Choosing audio input options / 105

    Choosing audio output options / 107

Recording an alert sound / 108

Connecting external stereo speakers / 108

Playing audio CDs / 109

*Index / 111*

## Communications regulation information

### FCC statement

The equipment described in this manual generates and uses radio-frequency energy. If it is not installed and used properly—that is, in strict accordance with Apple’s instructions—it may cause interference with radio and television reception.

This equipment has been tested and found to comply with the limits for a Class B digital device pursuant to the specifications in Part 15 of Federal Communications Commission (FCC) rules. These limits are designed to provide reasonable protection against such interference in a residential installation. However, there is no guarantee that the interference will not occur in a particular installation.

You can determine whether your computer is causing interference by turning it off. If the interference stops, it was probably caused by the computer or one of the peripheral devices.

If your computer system does cause interference to radio or television reception, try to correct the interference by using one or more of the following measures:

- Turn the television or radio antenna until the interference stops.
- Move the computer to one side or the other of the television or radio.
- Move the computer farther away from the television or radio.
- Plug the computer into an outlet that is on a different circuit from the television or radio.

(That is, make certain the computer and the television or radio are on circuits controlled by different circuit breakers or fuses.)

- Install a rooftop television antenna with a coaxial cable lead-in between the antenna and the television.

If necessary, consult an Apple-authorized service provider or Apple for assistance. See the service and support information that came with your Apple product. Or contact an experienced radio-television technician for additional suggestions. You may find helpful the following booklet, prepared by the FCC: *Interference Handbook* (stock number 004-000-00493-1). This booklet is available from the U.S. Government Printing Office, Washington, DC 20402.

**IMPORTANT** Changes or modifications to this product not authorized by Apple Computer, Inc., could void the FCC certification and negate your authority to operate the product. This product was tested for FCC compliance under conditions that included the use of shielded cables and connectors between system components. It is important that you use shielded cables and connectors to reduce the possibility of causing interference to radios, television sets, and other electronic devices. For Apple peripheral devices, you can obtain the proper shielded cables through an Apple-authorized dealer. For non-Apple peripheral devices, contact the manufacturer or dealer for assistance.

### DOC statement

#### DOC Class B Compliance

This digital apparatus does not exceed the Class B limits for radio noise emissions from digital apparatus set out in the radio interference regulations of the Canadian Department of Communications.

#### Observation des normes—Classe B

Le présent appareil numérique n’émet pas de bruits radioélectriques dépassant les limites applicables aux appareils numériques de la Classe B prescrites dans les règlements sur le brouillage radioélectrique édictés par le Ministère des Communications du Canada.

### VCCI statement

情報処理装置等電波障害自主規制について

この装置は、第二種情報装置（住宅地域又はその隣接した地域において使用されるべき情報装置）で住宅地域での電波障害防止を目的とした情報処理装置等電波障害自主規制協議会（VCCI）基準に適合しております。

しかし、本装置をラジオ、テレビジョン受信機に近接してご使用になると、受信障害の原因となることがあります。

取扱説明書に従って正しい取り扱いをしてください。

## Laser information

**WARNING** Making adjustments or performing procedures other than those specified in your equipment's documentation may result in hazardous exposure.

**WARNING** Do not attempt to disassemble the cabinet containing the laser. The laser beam used in this product is harmful to the eyes. The use of optical instruments, such as magnifying lenses, with this product increases the potential hazard to your eyes. For your safety, have this equipment serviced only by an Apple-authorized service provider.

Your computer is a Class 1 laser product. The following Class 1 and service warning labels are on the CD-ROM drive inside the computer. The Class 1 label indicates that the drive meets minimum safety requirements.

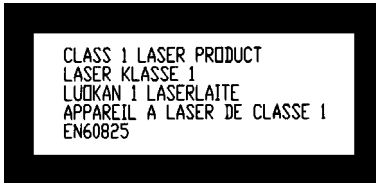

Class 1 label



## Preface

## About This Guide

This guide tells you how to set up your Workgroup Server 6150/66 and connect it to your LocalTalk or Ethernet network. The guide also provides information about expanding your server, using software, and troubleshooting problems that may arise.

*Note:* For easier reading, the Workgroup Server 6150/66 will be referred to as the Workgroup Server 6150 throughout this guide.

### About your Workgroup Server 6150 and Power Macintosh software

Your Workgroup Server 6150 is powered by the new PowerPC microprocessor (or “chip”). This microprocessor was designed by Apple Computer, Inc., Motorola, Inc., and IBM Corporation. The PowerPC microprocessor uses Reduced Instruction Set Computer (RISC) technology to deliver very high performance at the lowest possible cost. The PowerPC RISC microprocessor represents the state of the art in microprocessor design.

Your Workgroup Server 6150 will run almost all of your existing Macintosh software, but for best performance and greatest speed, look for software programs designed especially for Power Macintosh computers. You’ll find Power Macintosh programs at any software store that carries products for Macintosh.

---

## Who should read this guide

This guide is intended for the person who sets up the server and connects it to an existing network. You should be familiar with basic Macintosh terms, concepts, and techniques. If you're new to the Macintosh environment, see Appendix B, "Getting Help," after setting up your server system. You also need to know some details of your existing network to choose the appropriate procedures for connecting the server to your network.

## What this guide contains

Here's a brief summary of what you'll find in this guide:

- Chapter 1, "Setting Up Your Server," explains how to connect the monitor, keyboard, and mouse, and how to start up your server for the first time.
- Chapter 2, "Connecting to the Network," describes how to connect the server to an Ethernet or LocalTalk network.
- Chapter 3, "Expanding Your Server and Connecting Other Equipment," describes how to install an expansion card, add memory to the server, and connect additional internal and external devices.
- Chapter 4, "Using Software With Your Server," discusses running Power Macintosh software and server application programs (including network services).
- Chapter 5, "Troubleshooting," helps you solve problems with the server. This chapter also explains how to reinstall system software.
- Appendix A, "Safety, Maintenance, and Health Information," suggests how you can create a healthful and safe server environment and keep your server equipment in good working order.
- Appendix B, "Getting Help," describes how to use the various kinds of on-screen help available in the Guide menu.
- Appendix C, "Special Keys on Your Keyboard," describes the uses of unique keys as shortcuts for menu commands and alternatives to using the mouse.
- Appendix D, "Using Stereo Audio," explains how to use your server's stereo audio capabilities.

## How to use this guide

*Familiarize yourself with your server's basic components.* See the section “Your Server at a Glance” in Chapter 1.

*Consider security issues and placement of your server.* Read the section “Security Issues” in Chapter 1 for important information about protecting your server from unauthorized access.

*If you want to add an expansion card to the server:* Install the card or internal device according to the instructions in Chapter 3, “Expanding Your Server and Connecting Other Equipment.” Then return to Chapter 1 to connect the monitor and keyboard.

*If you want to connect external peripheral devices to your server:* After you connect the monitor and keyboard to the server, as described in Chapter 1, turn to the appropriate instructions in Chapter 3; then return to Chapter 1.

*Connect to the network to complete the setup process.* See Chapter 2, “Connecting to the Network,” for details.

*If you are new to Macintosh:* After setting up the hardware and turning your server on, refer to Appendix B, “Getting Help,” to learn how to use the features of Macintosh system software and application programs.

Be sure to read other sections of the book that are relevant to your work environment. Also, be sure to keep this book in a handy location; if you experience problems while using your server, you may need to refer to Chapter 5, “Troubleshooting.”

## For on-screen help and information

There are several valuable sources of help and information that you can view directly on your server's monitor screen, as described in this section.

### Workgroup Server Read Me

It is important that you read the Workgroup Server Read Me file, which contains late-breaking information about your server. This file is located on the server's hard disk and on the *Workgroup Server Software* CD-ROM disc. You may want to print this file for future reference.

### The Guide menu

Starting with system software version 7.5, you have instant access to new kinds of help when using your system and application programs. You can see your options in the Guide (⌘?) menu in the upper-right corner of the screen.

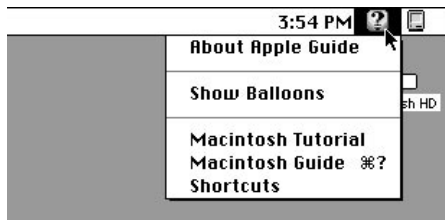

You'll find the instructions available in Macintosh Guide particularly useful when you have questions or encounter problems with your system software. For more details on the types of on-screen help available, refer to Appendix B, "Getting Help," and explore your options in the Guide menu.

### Workgroup Server Electronic Library

For your convenience, electronic versions of your server's documentation are provided on your server's hard disk and on the *Workgroup Server Software* CD-ROM disc. You'll find these documents in a folder called the Electronic Library. To read a document, just double-click to open it. You'll find on-screen help available in the document.

The Electronic Library folder contains electronic versions of the following documents:

- this book, the *Administrator's Guide*
- the *Technical Information* booklet for the Workgroup Server 6150
- the *Apple RAID Software Administrator's Guide*
- other user's guides for software that may have come with your server

### Other reference material

In addition to this guide, you may need to consult the following sources of information.

- *Technical Information:* See this booklet for the technical specifications of your server.
- The user's guide for the CD-ROM drive that came with your server. See this guide for information about using CD-ROM discs, playing audio compact discs and audio tracks on CD-ROM discs, and working with Photo CD discs.
- For information about server application programs included with your Workgroup Server 6150, such as Apple RAID Software and Retrospect Remote, refer to the documentation for those programs included in the server accessory kit.
- There are a number of network services, such as AppleShare, AppleSearch, and Apple Remote Access, that can be installed on your Workgroup Server 6150. Refer to the documentation included with those services for installation and operation information.

For late-breaking information about your server and system software, see the Workgroup Server Read Me file, located on the server's hard disk and on the *Workgroup Server Software* CD-ROM disc.

## Where to find answers

As you begin to use your server, remember that you have a number of resources available when you need assistance:

---



### In this book

Use this book to help you set up your server and learn about it, or to find solutions to problems.



### In the Guide menu

The Guide menu (marked with the  icon) is your main source of information about system software. To learn how to get different kinds of help from the Guide menu, see Appendix B in this book.

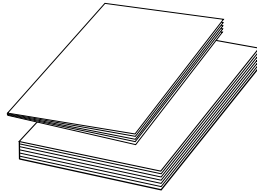

### In other manuals

For answers to questions about other equipment or about application programs you have purchased, see the manuals that came with the equipment or programs.



### From Apple's customer support hotline

If you can't find an answer in any of the materials provided, call the customer support hotline. (The phone number for the hotline is in the service and support information that came with your computer.)

---

# 1

## Setting Up Your Server

Setting up your server involves connecting a monitor, mouse, and keyboard, expanding your system to suit your needs, and connecting to the network.

First, acquaint yourself with your server's features, as shown in the next section, "Your Server at a Glance." Also, be sure to read the section "Security Issues" for important information about protecting your server from unauthorized access. Then, if you want to install an expansion card or install other internal devices, see the appropriate sections in Chapter 3 before returning to the setup procedures in this chapter. Once you've connected the monitor, mouse, and keyboard, you may need to refer to Chapter 3 again if you're connecting external devices.

You complete the setup process by configuring your network connection, as described in Chapter 2.

---

## Your server at a glance

The following figure shows the basic components of your Workgroup Server 6150, assembled and connected to a network.

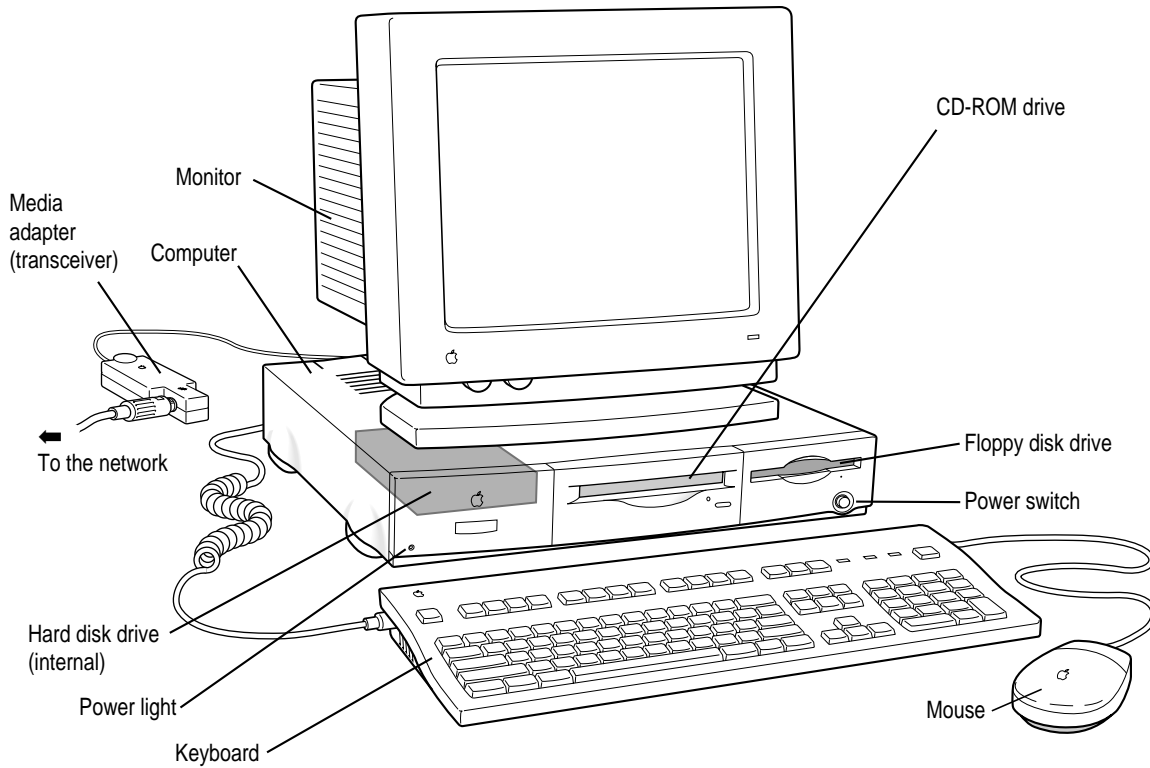

The ports on the back of the Workgroup Server 6150 and the icons that identify them are shown in the following figure. During setup, you'll connect hardware to some of these ports.

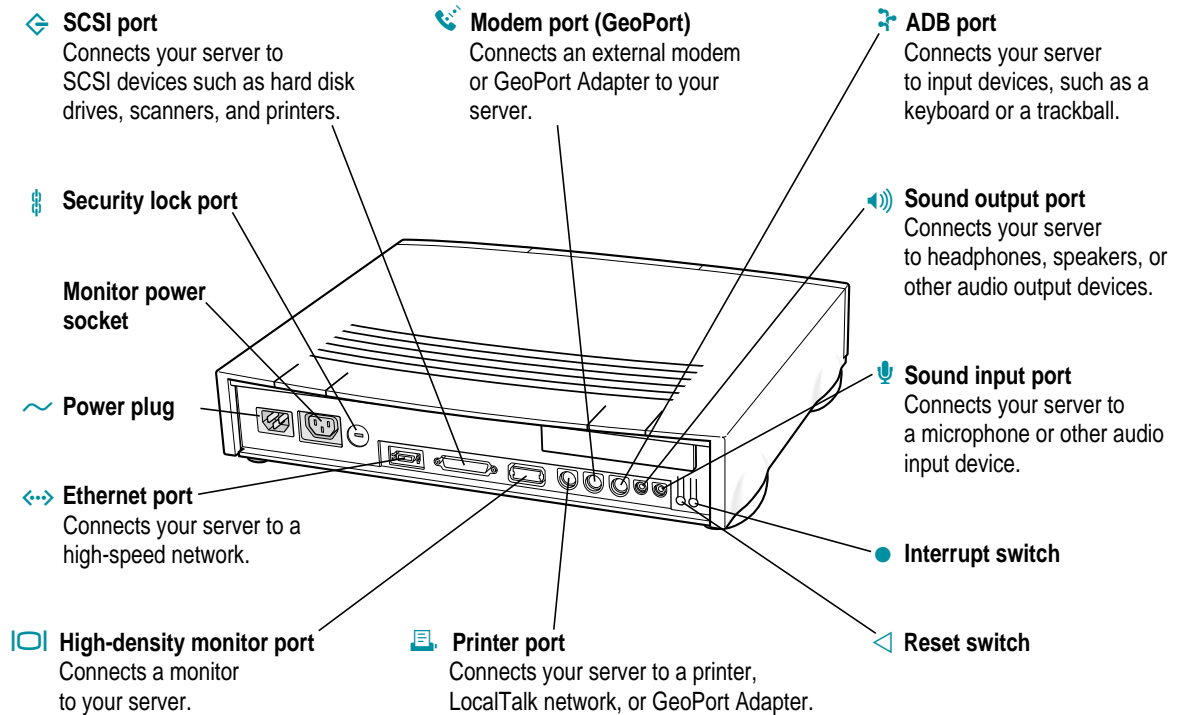

## Security issues

The Workgroup Server 6150 lets you concentrate valuable or sensitive information on one system that can be physically isolated and more carefully monitored than would be possible if that information were stored on personal computers. Before you set up the server, you may want to consider two measures that you can take to secure the hardware components: physically isolating the system and using a locking cable to secure the system.

## Physically isolating the system

It is important to note that even if software security features (such as password protection or locking screen savers) are in use on the server, it is still possible to disconnect peripheral devices—such as hard disks, which may contain confidential information—from your server system. There is no better way to protect hardware components than by physically isolating the server—locking it either in a well-ventilated cabinet or in a room with controlled access. Depending on your security needs, the nature of the data stored on the server may warrant the effort.

## Using a locking cable

As an alternative to isolating the system completely in an area of controlled access, you can purchase a locking cable and attach it to your server. The back panel has a built-in port for a locking cable. Follow the instructions supplied with the locking cable to secure it to your server.

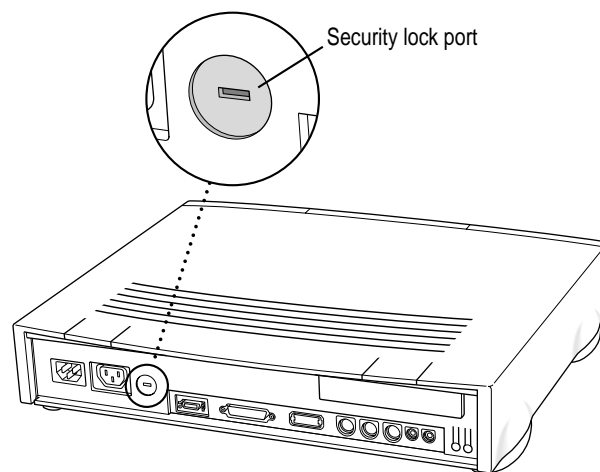

By itself, a locking cable cannot prevent unauthorized use of the server, but it can prevent the server (and its peripheral devices if they are also secured by locking cables) from being removed.

## Installing an expansion card

If you purchased an expansion card for your server, install it now (see “Installing an Expansion Card” in Chapter 3 for instructions). If you don’t have an expansion card, go on to the next section, “Connecting a Monitor.”

## Connecting a monitor

Your server has one high-density monitor port that accepts a monitor with a screen 16 inches or smaller (measured diagonally).

*Note:* You can use a larger monitor by installing a monitor card. See “Installing an Expansion Card” in Chapter 3.

You can connect many types of monitors to your server, including:

- *Most standard monitors.* See the *Technical Information* booklet that came with your server for a more detailed list. To connect a standard monitor, you must use the monitor cable adapter supplied with your server.
- *Apple AudioVision monitors.* AudioVision monitors include built-in speakers, a microphone, video, and an Apple Desktop Bus (ADB) port (for an input device such as a keyboard).

This section contains instructions for connecting either kind of monitor. To connect a monitor from a manufacturer other than Apple, refer also to the instructions that came with the monitor.

### Connecting the monitor’s power cord

Monitors have two cords to connect: a power cord and a monitor cable. To connect the monitor power cord:

#### 1 Place the monitor on top of or next to the server.

Keep in mind these considerations:

- Allow a few inches for air circulation around the server and monitor.
- Make sure the top of the screen is slightly below eye level when you’re sitting at the keyboard.
- Position the monitor to minimize glare and reflections on the screen from overhead lights and windows.

- If your monitor's screen is larger than 17 inches measured diagonally, place it next to the server (a monitor of this size is too heavy to sit directly on the server's case).
- Consult "Arranging Your Office" in Appendix A for suggestions about locating your server equipment.

**2 Connect the monitor's power cord to the monitor.**

On some monitors, the cord is already attached.

**3 Plug in the monitor's power cord.**

Some power cords are designed to plug into the back of your server. You can also plug the power cord into a grounded electrical outlet (an adapter may be needed).

*Note:* If you have an Apple AudioVision monitor, plug the monitor's power cord into the back of the server, not into an outlet.

Some monitors have to be connected to a grounded electrical outlet, not to the server's power socket. Check the information that came with the monitor.

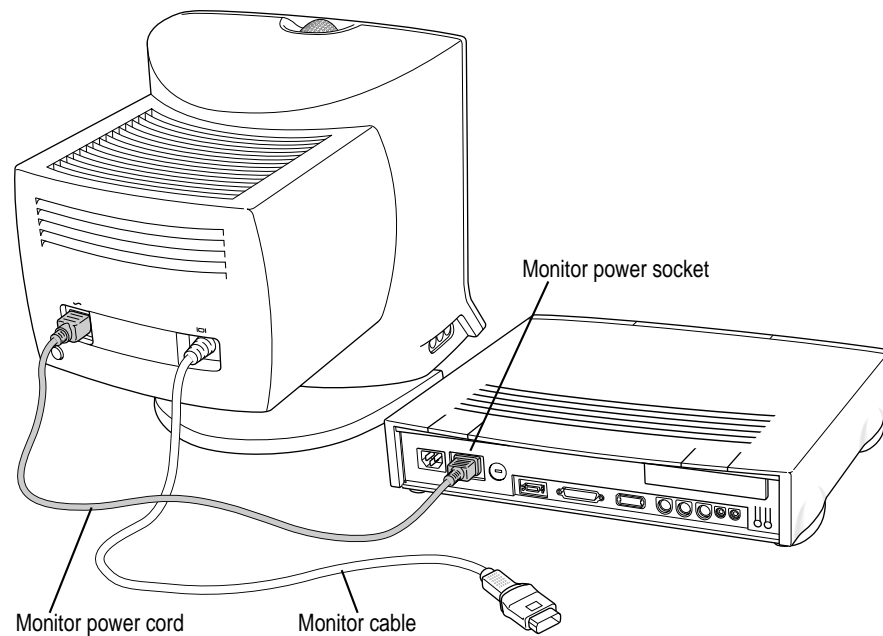

After you plug in your monitor's power cord, you need to connect the monitor cable, as described in the next section.

## Connecting the monitor cable

After you plug in the monitor's power cord, you connect the monitor cable to the server's monitor port.

To connect the monitor cable:

- 1 Attach the monitor cable to the monitor.**  
On some monitors, the cable is already attached.
- 2 If you have a standard monitor, attach the monitor cable adapter to the monitor cable.**

The monitor cable adapter comes with your server.

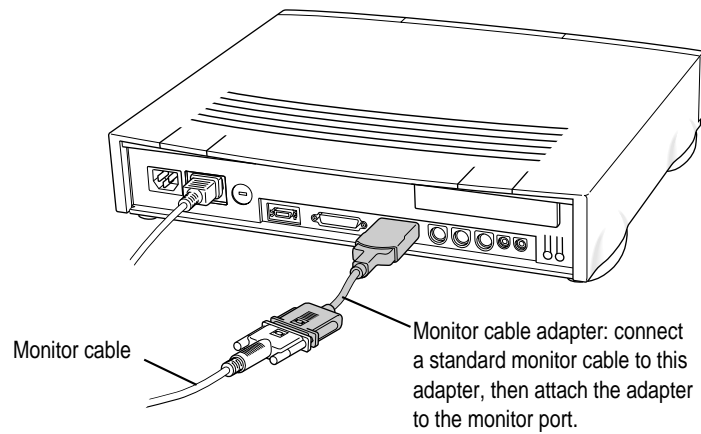

- 3 Attach the monitor cable or adapter to the server's monitor port.**

The monitor port is marked with the icon . To connect the cable, firmly push it into the connector until you hear a click.

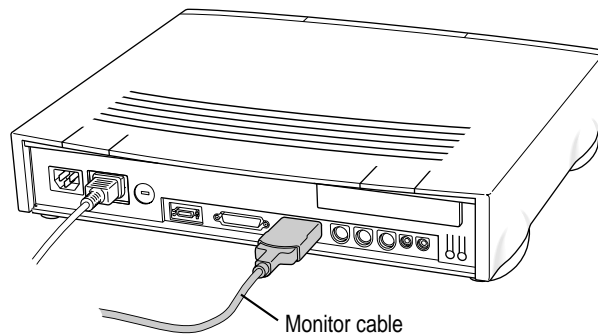

If you have an AudioVision monitor, see the information that came with the monitor to learn about its special features.

## Connecting the mouse and keyboard

You have a choice of several keyboards for your server. They are all connected the same way.

- 1 Plug the mouse cable into the port on either side of the keyboard.**

Most right-handed people prefer to use the mouse with their right hand; most left-handed people prefer to use the mouse with their left hand. Plug the mouse into the port on the side you prefer.

The plug and the port are marked with the same icon (⌘). Align the icons before you insert the plug. The positions of the port and icon on your keyboard may be different from those pictured.

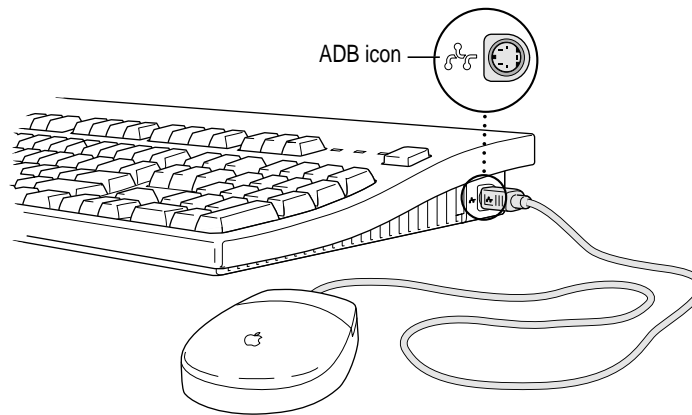

*Note:* The ⌘ port is called the Apple Desktop Bus (ADB) port.

- 2 Plug the keyboard cable (both ends are the same) into the other port on the keyboard.**
- 3 Plug the keyboard cable into the port on the back of the server marked with the ⌘ icon.**

Some monitors have a ⌘ port to which you can connect the keyboard or mouse. See the information that came with your monitor.

## Connecting other devices

If you want to connect other devices to your server, such as an external hard disk or a printer, follow the instructions in Chapter 3.

## Plugging in the server

To plug in the server:

- 1 Plug the socket end of the server's power cord into the recessed power plug (marked with the symbol ~) on the back of the server.
- 2 Plug the other end of the power cord into a three-hole grounded outlet or power strip.

Choose a power outlet to which you have easy access.

**WARNING** This equipment is intended to be electrically grounded. Your server is equipped with a three-wire grounding plug—a plug that has a third (grounding) pin. This plug will fit only a grounded AC outlet. This is a safety feature. If you are unable to insert the plug into the outlet, contact a licensed electrician to replace the outlet with a properly grounded outlet. Do not defeat the purpose of the grounding plug!

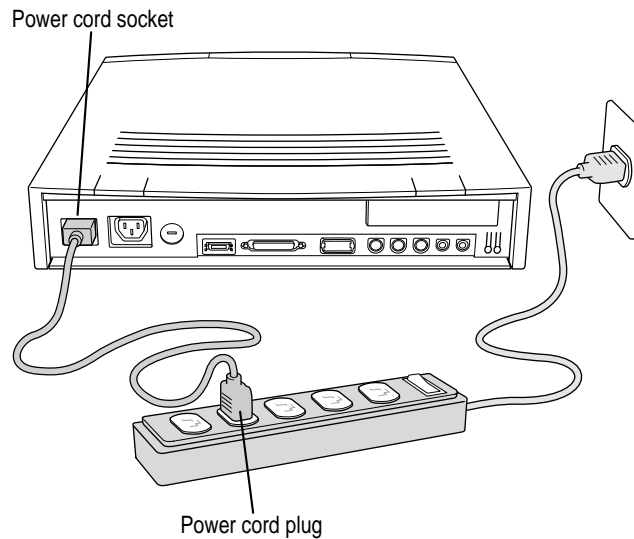

**IMPORTANT** Be sure at least one end of the power cord is within easy reach so that you can unplug the server when you need to.

When your server is off, it remains in a “standby” state, drawing a small amount of electrical current. This readies the server for a quick startup. If you ever need to disconnect power completely, unplug the server.

## Turning the server on

To turn on the server for the first time, follow these steps.

**IMPORTANT** If you have an AudioVision monitor, turn on your server before turning on the monitor (complete steps 2 and 3 first in the following procedure).

**1 Turn on your monitor.**

See the information that came with your monitor for the location of the power switch. On Apple monitors, the power switch has this icon: Ⓟ.

**2 Turn on all external devices.**

External devices may include hard disk drives or CD-ROM drives. The server checks only once—at startup—for the presence of external devices, so you need to turn on the devices before you turn on the server.

**3 Turn on the server by pressing the power switch on the front panel.**

The switch is marked with the Ⓟ icon.

You hear a tone from the server as it starts up.

**4 Check to see what’s on your screen, then click the OK button to dismiss the dialog box.**

- If you see a system message on the desktop, as shown in the following figure, your system software is already set up correctly.

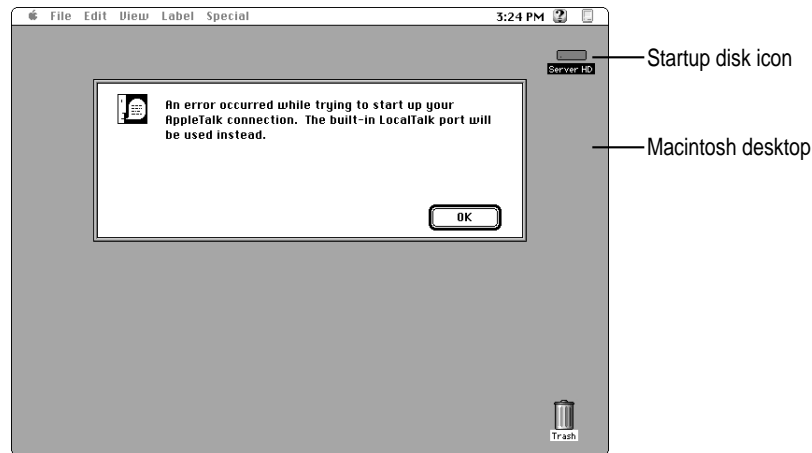

*Why the message about your network connection?* The Workgroup Server system software is preset for Ethernet networks. When you start up your server for the first time (before connecting a network cable), you'll see a dialog box alerting you that the system temporarily switched the network connection from built-in EtherTalk (software for Ethernet) to LocalTalk. However, if you shut down the server and connect to an Ethernet network later (as described in Chapter 2), the next time you start up, the system will automatically make the correct network connection for you.

- If you see a blinking question mark, you need to install system software on the server's hard disk. (System software is a set of programs the computer uses to start itself up.)



See "Reinstalling System Software" in Chapter 5 of this book for information on installing system software.

- If you see anything else on your screen, or if you see nothing at all, see the next section, "Problems Turning On Your Server?"

**IMPORTANT** If you need to turn off your server at any point, see the section "Turning the Server Off" later in this chapter. It is very important to use the correct procedure for shutting down your server before turning it off.

## Problems turning on your server?

If you don't see anything on the screen, check these items to see if you can identify the problem:

- Is the server plugged into a power source? If it is plugged into a power strip, is the power strip turned on?
- Is the power light on the front panel on?
- Are the keyboard and mouse cables connected correctly? (Don't disconnect the keyboard or mouse cables while your server is on. You could damage your equipment.)
- Is the monitor power cord plugged in?
- Is the monitor turned on? (Check the power-on light on the front of the monitor.)
- Is the monitor's cable attached firmly to both the monitor and server?
- Are the brightness and contrast controls on the monitor adjusted correctly? (On Apple monitors, the brightness control is marked with the symbol ☼ and the contrast control is marked with the symbol ●.)

## Setting the system time and date

It's important that you set the current time and date for your server so that the system can correctly log system events and record file activity. You set the time and date in the Date & Time control panel. When setting the time, you can also specify whether time is displayed on a 12-hour or 24-hour clock. To get step-by-step instructions for setting the system time and date, see the "Setting Options" topic of Macintosh Guide, available in the Guide (🔍) menu.

*Note:* If you're new to Macintosh, now is a good time to refer to Appendix B, "Getting Help."

## Turning the server off

You need to turn off the server to connect to the network as described in Chapter 2.

**1 Use the mouse to choose the Shut Down command from the Special menu.**

Choosing Shut Down readies the hard disk for a fast restart next time you turn on the server. It also prompts you to save any unsaved work on a disk before turning the power off.



**WARNING** If you use the power switch to turn off the server before choosing Shut Down, you will lose any work you haven't saved onto a disk, you risk losing open documents, and you risk damaging your system software.

**2 When a message appears, telling you it is safe to switch off your server, press the power switch on the front of the server.**

If your monitor is plugged into the server, the screen will go dark, but the monitor will continue to consume electricity. To turn the monitor off, use its power switch.

To turn the server on again, just press the power switch on the front of the server.

**IMPORTANT** Be sure to shut down the server if you need to do any of the following:

- move the server
- connect other equipment to the server
- unplug the server



# 2

## Connecting to the Network

The Workgroup Server 6150 contains built-in hardware and software for connecting the server to two types of networks: LocalTalk and Ethernet. You connect the server to a LocalTalk network through the printer port. The built-in Ethernet port on the Workgroup Server 6150 lets you connect the server to a high-speed Ethernet network. Connecting to either type of network requires a piece of hardware, which you must purchase separately from your server, called a *transceiver* or *media adapter* for the type of network cables that your network uses.

*Note:* With the appropriate communications card and software, you can also connect your server to other network types, such as a Token Ring or an FDDI network. See your Apple-authorized dealer for more information.

---

## Connecting to an Ethernet network

The built-in Ethernet capabilities of your Workgroup Server 6150 allow you to connect to any standard Ethernet network using thin coaxial (or “coax”), 10BASE-T twisted-pair, or thick coaxial cables; fiber-optic media; or other standard Ethernet cables.

To connect the server to an Ethernet network, you need one of the following Ethernet media adapters for the type of cables that your network uses:

- Apple Ethernet Thin Coax Transceiver
- Apple Ethernet Twisted-Pair Transceiver
- Apple Ethernet AUI Adapter

See your Apple-authorized dealer for more information on Apple Ethernet media adapters for your Workgroup Server 6150.

**WARNING** Do not connect cables to the back of the computer when the power is on or you may damage your system.

You can connect an adapter and cable for an Ethernet network directly to the server without installing an expansion card. You can find the Ethernet port on the back of your server by looking for the Ethernet icon:

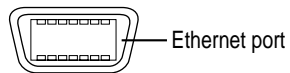
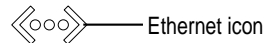

The following sections provide the basic instructions for connecting your server at the end of an Ethernet network. However, your server can be connected anywhere along a network, but to do so requires that you temporarily disconnect the network, which could disrupt existing network services for other network users. When you disconnect the network, work efficiently so that you minimize disruption to other users. For additional information about connecting to Ethernet networks, see the documentation that came with your media adapter.

## Connecting to thin coaxial Ethernet

Follow this procedure to connect the server to an Ethernet network that uses thin coaxial cable. The hardware connection requires an Apple (or Apple-compatible) thin coaxial transceiver and a thin coaxial cable.

To connect the server to a thin coaxial network:

- 1 Make sure that the server is turned off.**
- 2 Attach one end of a thin coaxial cable to one of the posts on the thin coaxial transceiver.**
- 3 Attach the other end of the cable to the last thin coaxial transceiver on the network.**

A thin coaxial network must be terminated at the endpoints to function. An Apple transceiver is self-terminating. A non-Apple transceiver may require a terminator; check the documentation that came with the transceiver.

- 4 Plug the connector on the transceiver into the Ethernet port on the server.**

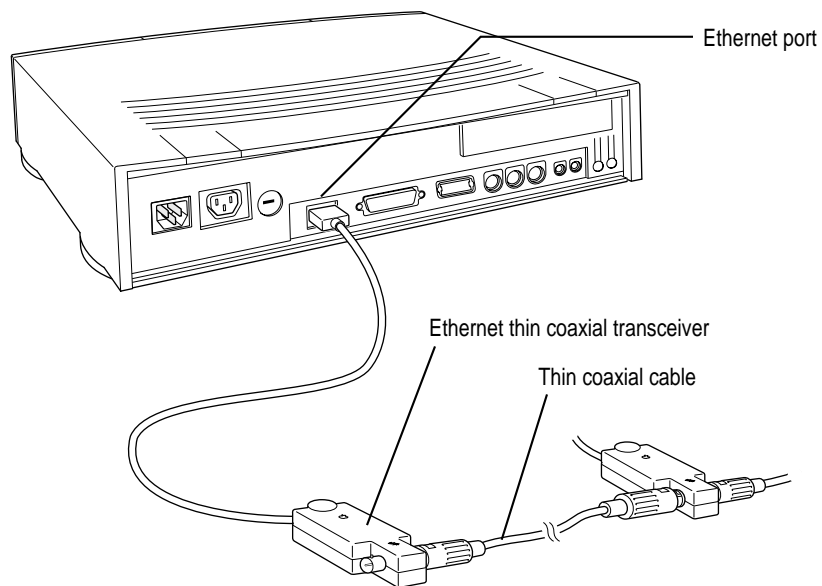

The server is preset to use the network software connection for Ethernet. You can use network services as soon as you start up the server.

## Connecting to twisted-pair Ethernet

Follow this procedure to connect the server to a network that implements Ethernet over twisted-pair cable. The hardware connection requires an Apple (or Apple-compatible) twisted-pair transceiver and a twisted-pair patch cord with an RJ-45 telephone-style connector jack. You plug the transceiver into a standard wall plate that is connected to a centralized 10BASE-T hub.

To connect the server to a twisted-pair network:

- 1 Make sure that the server is turned off.**
- 2 Plug one end of the twisted-pair patch cord into the transceiver and the other end into an RJ-45 wall outlet that supports twisted-pair Ethernet.**

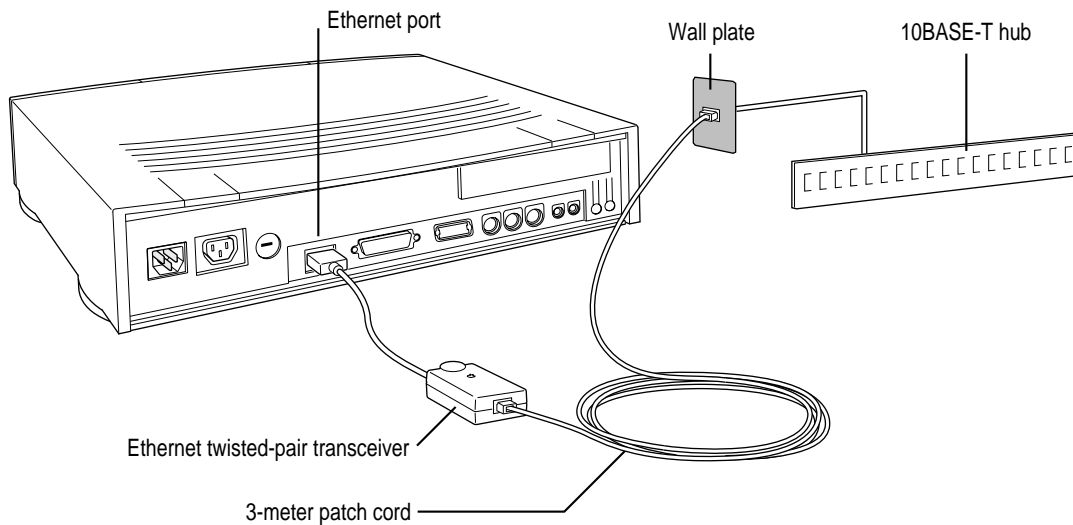

- 3 Plug the connector on the transceiver into the Ethernet port on the server.**

*Note:* After you start up the server, check that the green light-emitting diode (LED) on the twisted-pair transceiver is lit. The LED will confirm that the server is properly connected to the hub.

The server is preset to use the network software connection for Ethernet. You can use network services as soon as you start up the server.

## Connecting to other types of Ethernet

The Apple Ethernet AUI Adapter is a universal adapter that lets you connect the server to less-common types of industry-standard Ethernet media, such as thick coaxial or fiber-optic cable. If you are using the Apple Ethernet AUI Adapter, you also need an Ethernet transceiver for your specific media type, and the transceiver must have a standard AUI (Attachment Unit Interface) port on it.

To connect the server to an Ethernet transceiver for other types of Ethernet media:

- 1 Make sure that the server is turned off.**
- 2 Connect the Ethernet transceiver to the network.**  
See the documentation for the type of Ethernet transceiver that you have.
- 3 Plug the transceiver cable from the Ethernet transceiver into the standard AUI port on the Apple Ethernet AUI Adapter.**

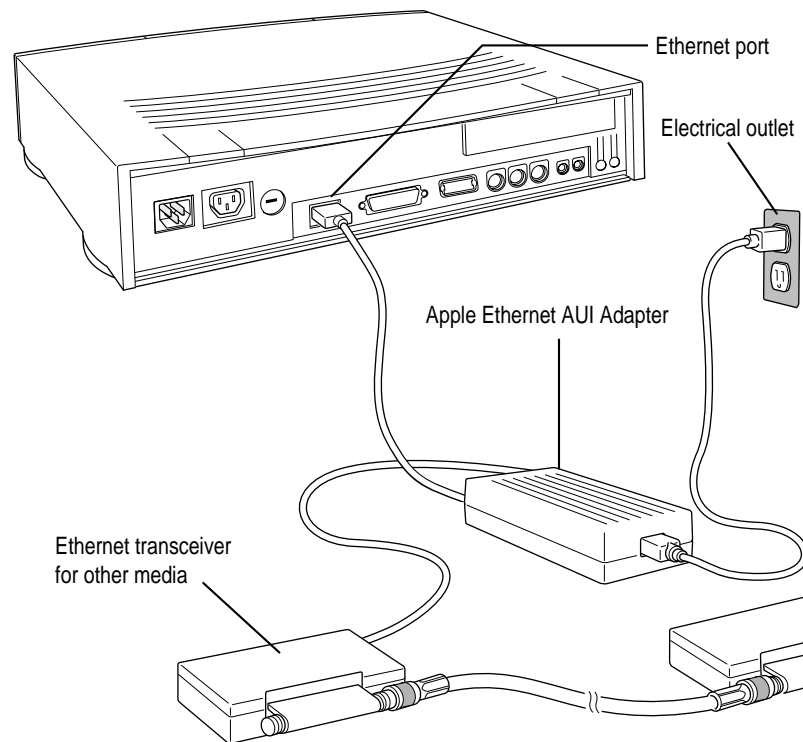

- 4 **Plug the adapter's power cord into a power outlet.**
- 5 **Plug the connector on the Apple Ethernet AUI Adapter into the Ethernet port on the server.**

The server is preset to use the network software connection for Ethernet. You can use network services as soon as you start up the server.

## Connecting to a LocalTalk network

The Apple LocalTalk Locking Connector Kit DIN-8, available from your Apple-authorized dealer, lets you connect the server to an existing LocalTalk network by means of the printer port.

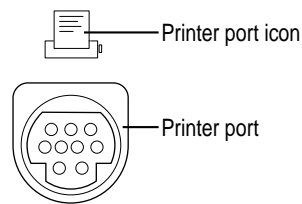

To connect the server to a LocalTalk network:

- 1 **Make sure that the server is turned off.**
- 2 **Attach the LocalTalk adapter to the printer port.**
- 3 **Plug one end of a LocalTalk cable into the LocalTalk adapter.**
- 4 **Plug the other end of the cable into the last LocalTalk adapter on the network.**

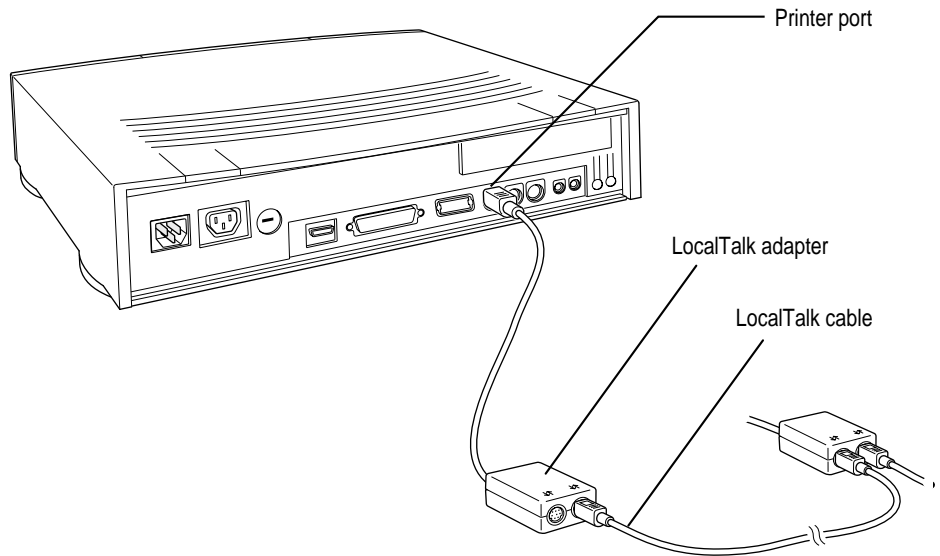

Now that you have made the server's physical connection to LocalTalk, you can start up the server.

**IMPORTANT** After connecting to a LocalTalk network (if you have not also connected to Ethernet), each time you start up the server you'll see a dialog box that indicates an error condition. This dialog box informs you that the system has made a temporary switch from EtherTalk (its preset network software connection) to LocalTalk. You will see this message until you change the default setting in the Network control panel. After you turn the server on (as described in Chapter 1), be sure to continue with the next section in this chapter to learn how to switch the setting in the Network control panel.

## If you need to switch the network connection

Your Workgroup Server 6150 includes AppleTalk networking software, which can run on both Ethernet and LocalTalk networks. (You can also add software for other networks.) The built-in AppleTalk software for Ethernet networks is called *EtherTalk*. Depending on the type of network to which you connect your server, you may need to change the network connection setting for your server system.

The Workgroup Server is preset to use the EtherTalk network connection. If the server is not physically connected to an Ethernet network when you start up, the system software reports an error condition and temporarily switches to LocalTalk. If you will not be using an Ethernet network, you need to switch the connection in the Network control panel to the appropriate network.

*Note:* The server can be physically connected to more than one network, but you can use only one network connection at a time.

If you need to switch the server's network connection, follow these steps:

- 1 Turn on the server.
- 2 Choose Control Panels from the Apple (🍏) menu and open the Network control panel.

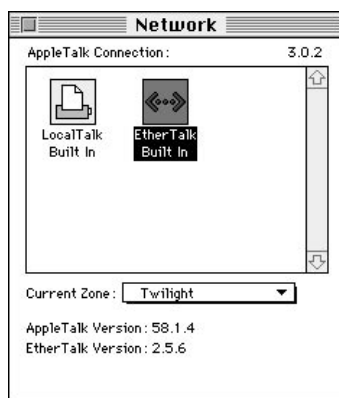

**3 Click the icon of the new network connection that you want to use.**

An alert box appears, warning you that you may be disconnected from any network services (such as network printers) that may be available with your current network connection. (Your network connection types may be different from those shown in the following example.)



**4 Click OK.**

**5 Close the Network control panel.**

You can now use the network connection you selected.



# 3

## Expanding Your Server and Connecting Other Equipment

You can expand the capabilities of your server by installing items internally and by connecting external devices. The following figure shows you the location of the Workgroup Server 6150's internal components. An external view of the server, depicting the ports to which you connect other devices, is shown in the section "Your Server at a Glance" in Chapter 1.

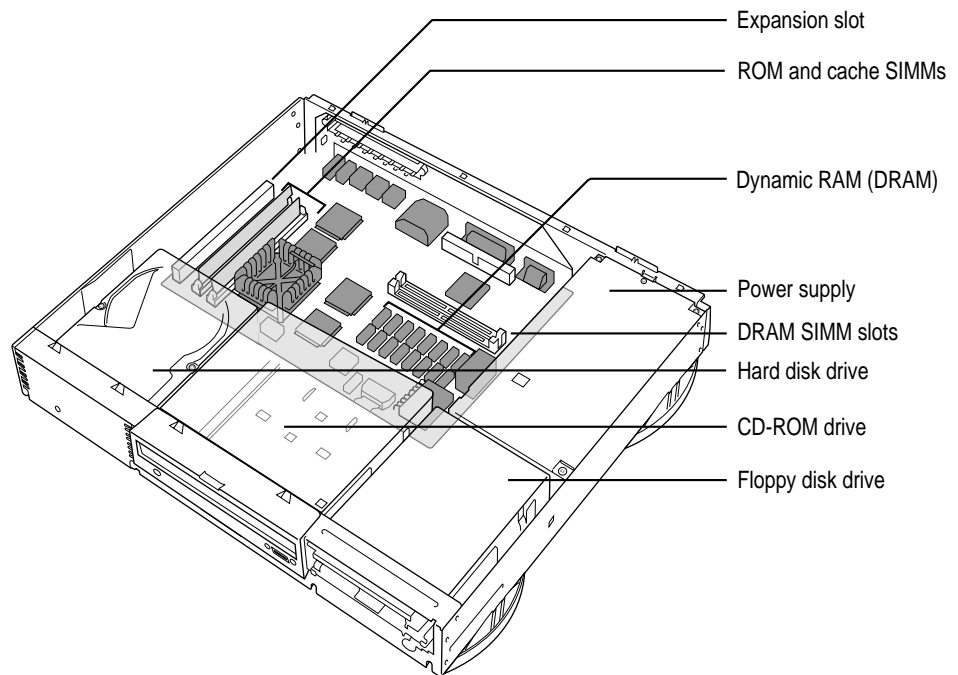

## Installing an expansion card

You can install a printed circuit board (called a *card*) for video and graphics applications, networking and communications, additional processing power, or other purposes. The card fits into a connector, called an *expansion slot*, inside the server.

Your server has one expansion slot designed to accept a processor-direct slot (PDS) card or a NuBus™ card. Each card requires an adapter, which allows it to fit into the expansion slot.

**IMPORTANT** The Workgroup Server 6150 does not accept expansion cards that are more than 7 inches in length.

**WARNING** Be sure to use the adapter designed specifically for the Workgroup Server 6150. Failure to do so could damage the card and your server.

**WARNING** Do not remove any factory-installed cards from inside your server. Pulling a factory-installed card out at an angle can damage your equipment. Any expansion card you install will not operate properly if a factory-installed card has been removed. If a factory-installed card needs to be removed, see an Apple-authorized service provider.

## Installing the card

**IMPORTANT** Some cards may need to be installed by an Apple-authorized service provider. Check the information that came with the card.

Follow these steps to install an expansion card.

- 1 **Shut down the server, disconnect any attached cables (including the power cord), and press the power switch once to discharge static electricity.**
- 2 **Remove the lid from the server.**

Pull up on the two latches at the rear corners of the case.

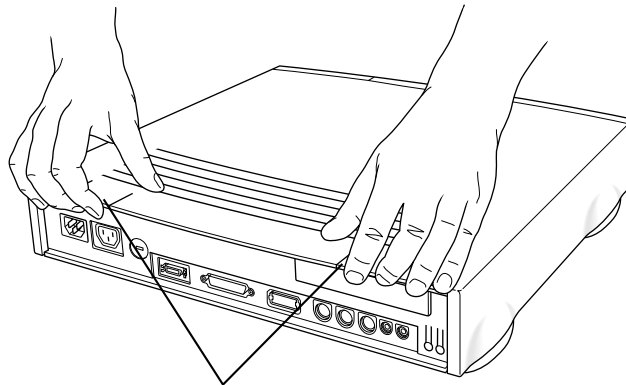

Lift up on the latches.

Tilt the cover and slide it toward the front panel. Then lift the cover off.

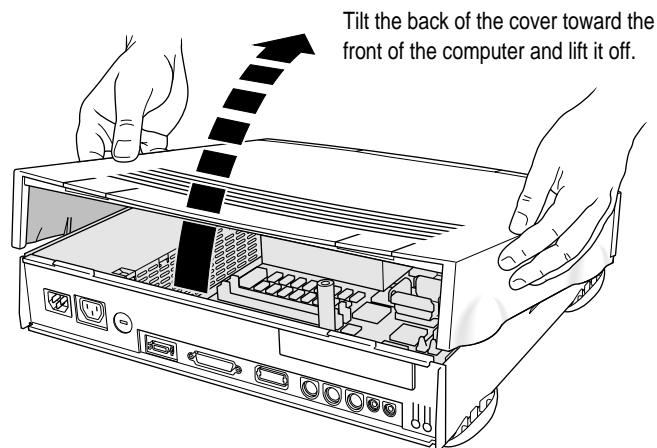

Tilt the back of the cover toward the front of the computer and lift it off.

- 3 Remove the cover from the access port on the back panel of your server and set it aside. Use your thumb to push out the access port cover.

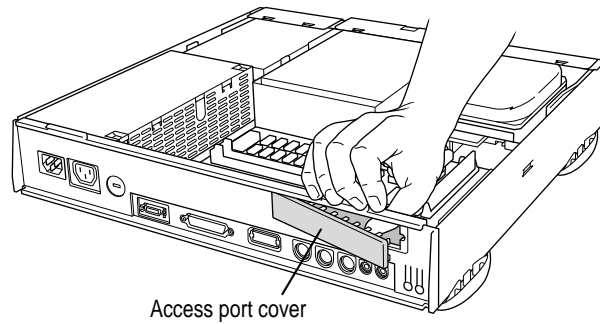

- 4 Touch the metal part of the power supply case inside the server to discharge static electricity. Always do this before you touch any parts, or install any components, inside the server.

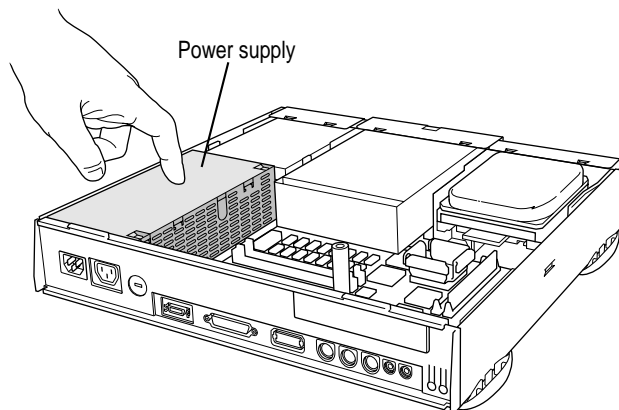

**5 Remove the card from its static-proof bag.**

Handle the card by its edges. Do not touch the connectors.

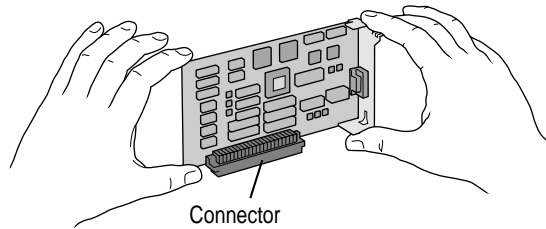

**6 Remove the adapter card assembly from its static-proof bag.**

The adapter card assembly consists of an adapter card attached to a metal bracket. Do not touch the connectors on the card.

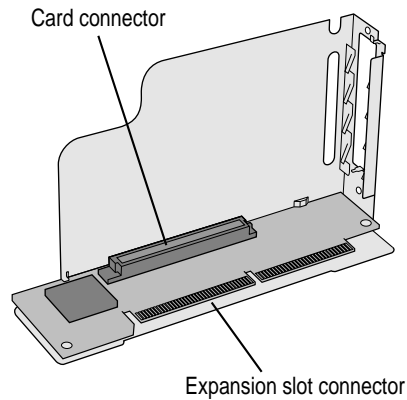

Set aside the thumbscrews that came with the adapter card. You'll need them later.

**7 Attach the card to the adapter card assembly.**

Rest the adapter card on the edge of a flat surface, with the metal bracket pointing up.

Slide the card into the bracket. The pin on the bracket should line up with the hole on the metal end of the card.

Press gently on the cards to push the connectors together.

When the cards are attached correctly, the pin fits into the hole and the guide fits into the slot, as shown in the illustration.

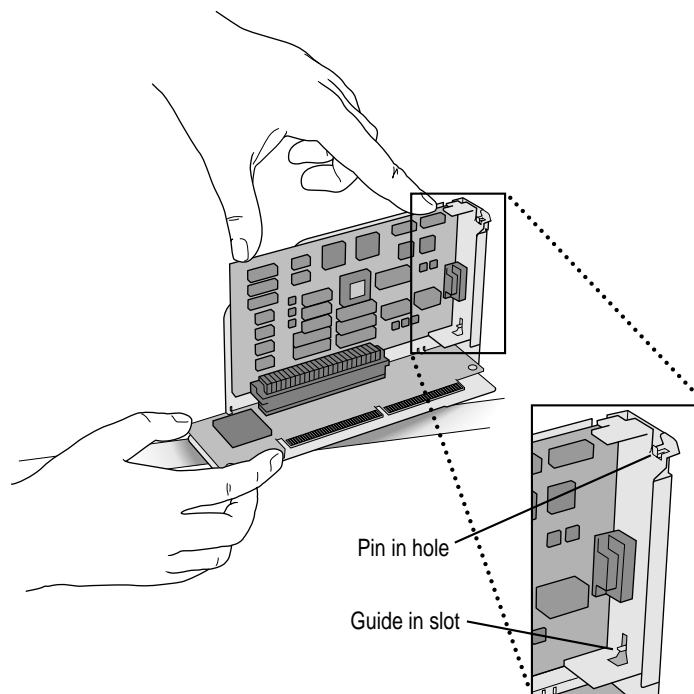

**8 Locate the expansion slot on the main circuit board.**

The expansion slot is at the far-left edge of the circuit board as you face the front of the server.

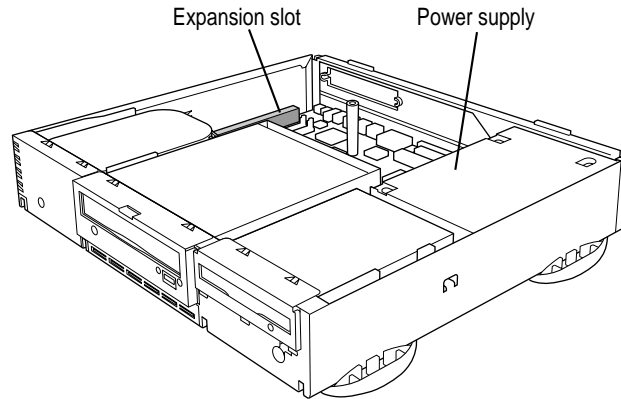

**9 Insert the connector on the adapter card into the expansion slot.**

Line up the connector with the slot. Then press down gently but firmly on the adapter card until the connector is fully inserted.

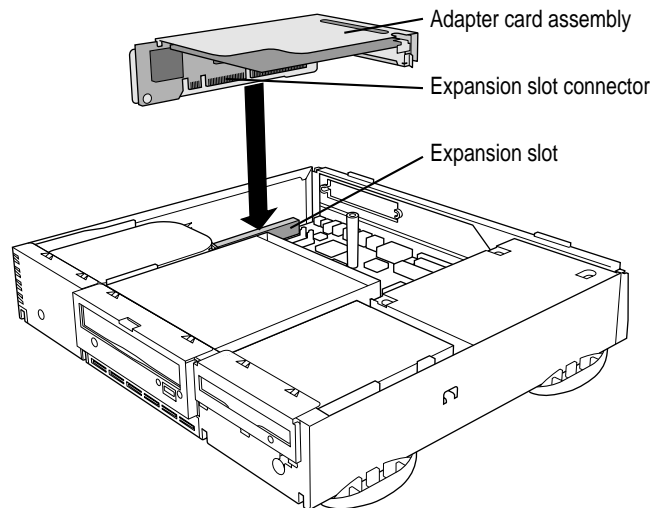

Make sure that the tab on the side of the card assembly slides into the slot on the side of the case, as shown.

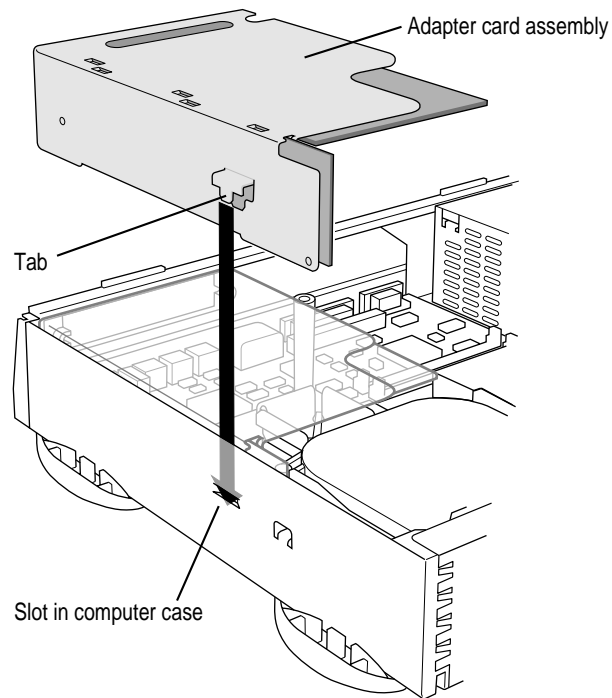

**10 Attach the thumbscrews to the access port on the server's back panel.**

Position the bracket against the access port while inserting and tightening the thumbscrews.

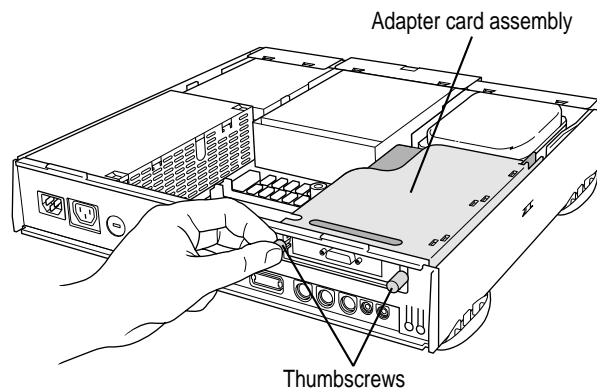

**11 Replace the cover on the server.**

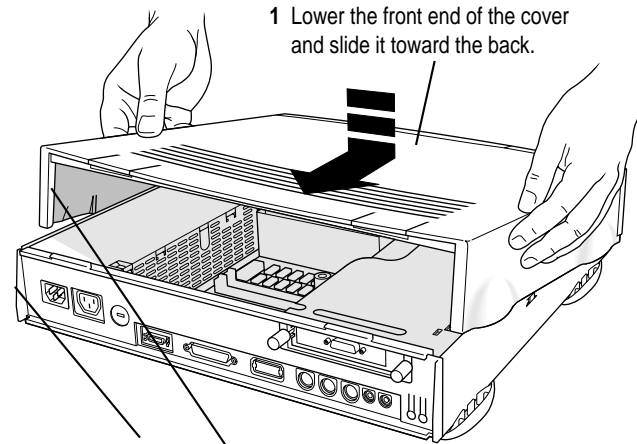

1 Lower the front end of the cover and slide it toward the back.

2 Engage the ribs on the bottom case with the slots in the cover.

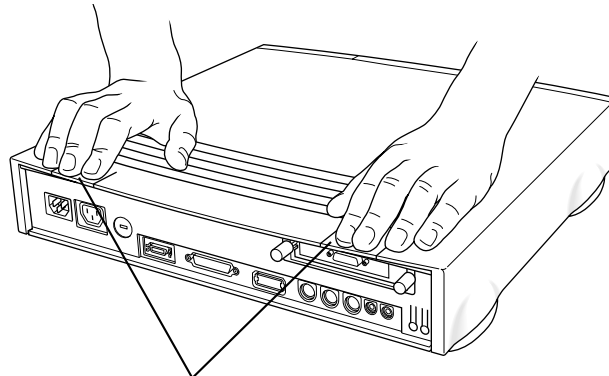

3 Press down on the latches to snap them into place.

**WARNING** Always replace the cover before turning the server on.

**12 Plug the server's power cord back into a power outlet.**

## Expanding memory

Additional random-access memory (RAM) can be installed in your server. The *Technical Information* booklet that came with your server describes how much additional memory can be installed in the server.

Memory for your server is provided in packages called *RAM SIMMs*. The SIMMs must be the correct type for your server. They should be installed in pairs of the same size into paired slots in your server. It is very important that the RAM SIMMs be correctly installed in your Workgroup Server 6150. Incorrect installation can result in errors, unpredictable results, and damage to your equipment and data.

**WARNING** To avoid damage to your server, Apple recommends that only an Apple-certified technician install additional RAM. If you attempt to install additional RAM yourself, any damage you may cause to your equipment will not be covered by the limited warranty on your server.

## Installing other internal devices

Your Workgroup Server 6150 holds three internal storage devices: a floppy disk drive, a CD-ROM drive, and a hard disk drive. If you want to replace any of these devices, see your Apple-authorized dealer for more information.

## Connecting hard disks and other SCSI devices

Your server has a port for connecting devices that use the Small Computer System Interface (SCSI, pronounced “skuh-zee”). The SCSI port permits high-speed communication between the server and the device. The SCSI icon appears above the port on the server’s back panel.

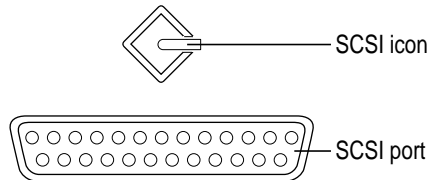

**IMPORTANT** Before connecting a device to your server, be sure that the server (and any other device already connected to it) is turned off. Read the instructions in this section and the instructions that came with your hard disk or other SCSI device before connecting it to your server.

SCSI devices commonly used with the Workgroup Server 6150 include hard disks, CD-ROM drives, scanners, printers, and tape-backup drives.

Your server comes with two SCSI devices already installed—an internal hard disk and a CD-ROM drive. You can connect up to five additional SCSI devices in a chain. Each device must have its own, unique ID number.

Setting up a SCSI device to use with your server involves

- setting the device's SCSI ID number
- physically connecting the device to your server
- installing any necessary device drivers (and restarting your system)

### Setting the SCSI ID number



See the instructions that came with your SCSI device for information on setting its SCSI ID number.

**WARNING** Each SCSI device connected to your server must have its own, unique ID number between 0 and 6. Using two or more devices with the same ID number can cause your equipment to malfunction. You could lose data as a result.

If you have an Apple SCSI device, set the SCSI ID number as follows:

- 1 **Make sure that the server and SCSI device are turned off.**
- 2 **Choose a number between 0 and 6 that doesn't duplicate the ID of any other SCSI device connected to your server.**

The startup disk's ID number is preset to 0 and the CD-ROM drive's ID is preset to 3. (The server itself has the ID number 7.) Therefore, the ID numbers that can be assigned are 1, 2, 4, 5, and 6, as shown in the following figure.

SCSI ID numbers						
0	1	2	3	4	5	6
						
Startup disk			CD-ROM drive			

- 3 **Locate the ID number switch on the back of your SCSI device.**

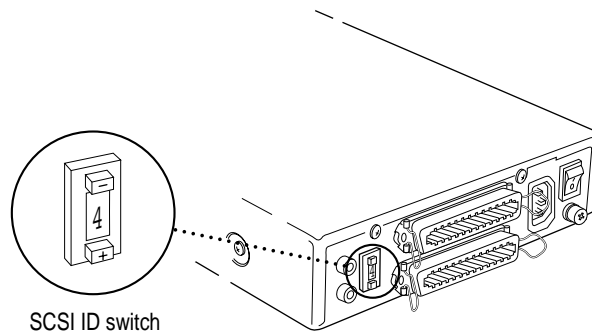

- 4 **Push the ID switch repeatedly until the number you want appears.**

On some SCSI devices, the ID number switch is inside a small hole. Insert a straightened paper clip to push the switch.

## Connecting a SCSI device

To connect a SCSI device to your server:

- 1 **If your server is turned on, shut it down.**
- 2 **Make sure the SCSI device is switched off.**

**WARNING** Do not connect or disconnect any device while the device or your server is turned on. Doing so could damage the device, your server, or both.

- 3 **Make sure the device has its own, unique ID number between 0 and 6.**  
See the previous section, “Setting the SCSI ID Number,” for details.
- 4 **Use a SCSI cable to connect the device either to the server’s SCSI port or to the last SCSI device already in the chain.**

If the device is the first or only one you’re connecting, use a SCSI system cable to connect it to the server’s SCSI port.

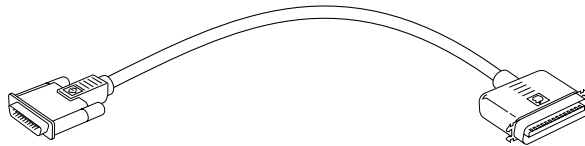

If the device is not the first one, use a SCSI peripheral interface cable to connect it to the last device in the chain.

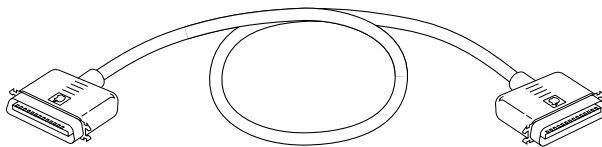

**IMPORTANT** To get the best results with SCSI devices, be sure to use high-quality SCSI cables and check that the total length of the cables in a SCSI chain does not exceed 6 meters (20 feet). Use SCSI cables manufactured by Apple Computer or those of similar quality.

**5 Make sure that only the last device in the SCSI chain has a terminator.**

To ensure accurate transmission of information, a terminator must be at each end of a SCSI chain. Your internal hard disk, which is the first device in the chain, has a built-in terminator.

Some external SCSI devices from manufacturers other than Apple have a built-in terminator. (Check the information that came with the device.) If the device at the end of the SCSI chain does not have a built-in terminator, you need to attach an external terminator.

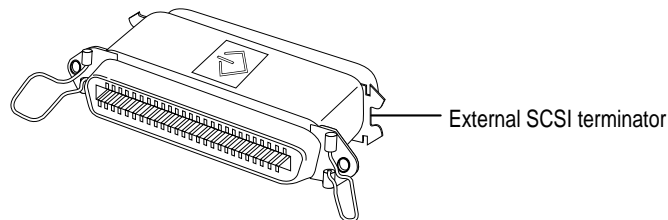

Have your Apple-authorized service provider remove any extra built-in terminators. You can attach or remove external terminators yourself.

*Note:* If only one external device has a built-in terminator, rearrange the SCSI chain so that device is at the end.

**IMPORTANT** Always turn on any external SCSI devices connected to your server before turning on the server itself. Otherwise, your server cannot recognize the SCSI devices.

### Installing a device driver

A device driver is software that lets the server communicate with a particular SCSI device.

*Note:* If you have set up your server and connected additional devices, but not yet turned the server on, return to the section “Plugging In the Server” in Chapter 1 before installing a device driver.

To install a driver:

- **Start up your server, if necessary, and drag the driver icon to the System Folder icon on your startup disk.**

Any drivers needed for a SCSI device are usually on a floppy disk that comes with the device. (If no drivers come with the device, then it doesn't need any.) You may have to restart your server to activate the driver.

## Do you need to initialize a hard disk?

You need to initialize a hard disk only in the following cases:

- *You're using specialized disk array management software, such as RAID (redundant array of independent disks).* See the documentation that accompanied the disk array management software for instructions.
- *The disk is new and uninitialized.* Your internal hard disk and most external hard disks are initialized at the factory and do not have to be initialized again. If you are adding a new non-Apple hard disk to your server, check your owner's manual to see if it needs to be initialized.
- *You've experienced repeated errors using this disk.* If problems persist after you reinitialize the disk, the disk is in need of servicing.
- *The disk has been formatted for use with a non-Apple operating system.*

You use the Apple HD SC Setup program to initialize and name a hard disk. Apple HD SC Setup is provided as part of your system software and can be found in the Utilities folder on the server's hard disk as well as on the *Workgroup Server Software* CD-ROM disc.

See the instructions for preparing a disk for use in the "Disks" topic in Macintosh Guide, available in the Guide (🔍) menu.

## Connecting a printer

Your server has a printer port, which you use to connect a printer to your server.

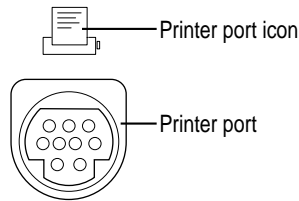

The printer port accepts either a direct cable connection (to printers such as the StyleWriter II) or a network cable connection (to printers such as a LaserWriter Pro or LaserWriter Select).

Follow the instructions that came with your printer when connecting it to your server.

A printer can also be connected to the modem port (GeoPort). You use the Chooser program to indicate the port you used to connect your printer. (See the “Printing and Fonts” topic in Macintosh Guide, available in the Guide (🔍) menu, for more information on using the Chooser and printing.)

## Connecting an additional monitor

You can use an additional monitor with your server if you install a video expansion card. See “Installing an Expansion Card” earlier in this chapter for instructions.

When you connect an additional monitor:

- Make sure that the ventilation openings on the server and the monitors are clear and unobstructed.
- If there is interference on your screens or on a television or radio near your server, reposition or separate the affected equipment.

## Connecting a trackball or other input device

Your server has an Apple Desktop Bus (ADB) port, which you use to connect the mouse, the keyboard, and other input devices such as a trackball, a bar-code reader, or a graphics tablet.

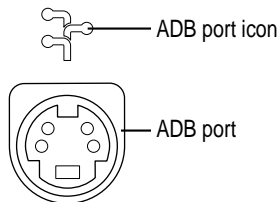

You can usually connect up to three ADB devices in a chain to a single port. The exact number depends on how much power the devices require.

**IMPORTANT** The total power used by all ADB devices connected to your server must not exceed 500 milliamperes (mA). Information about the power requirements of the mouse and keyboard are in the *Technical Information* booklet that came with your server. Check the information that came with your other ADB device for power requirements.

## Connecting a microphone

Your server has a sound input port, which you can use to connect a microphone. With appropriate software, you can use the microphone to give spoken commands to your server and to record your voice or other sounds.

The Apple PlainTalk Microphone and the software needed for using spoken commands are available from Apple-authorized dealers. If you want to use another microphone, make sure it is compatible with your Workgroup Server 6150.

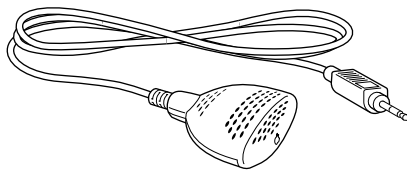

*Note:* The Apple AudioVision 14 Display has the Apple PlainTalk Microphone built in.

To connect the microphone:

- **Plug the microphone's connector into the sound input port (marked with the symbol  on the back of the server.**

See “Connecting an Audio Device” in Appendix D of this book for more information about the sound input port.

## Connecting a GeoPort Telecom Adapter or modem

Your server has a port, called the GeoPort, which is a serial port designed for use with devices such as the GeoPort Telecom Adapter. These devices, when used with appropriate telecommunications software, take advantage of the server's built-in modem capabilities. The GeoPort Telecom Adapter comes with communications and fax software and can be purchased from Apple-authorized dealers.

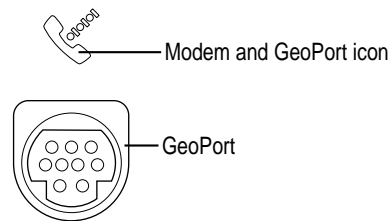

You can connect a standard modem to the GeoPort, using a standard modem cable.

To connect an adapter or modem to your server, follow the instructions that came with your adapter or modem.

You can also connect a printer to the GeoPort.

# 4

## Using Software With Your Server

This chapter provides important information you need to know about using your Workgroup Server 6150 with application programs. For instance, although your server is compatible with most programs intended for use with Macintosh computers, certain programs are designed especially for Power Macintosh computers. These kinds of programs take best advantage of your server's speed. In addition, the order in which certain programs start up affects a server's performance. Be sure to read the information in this chapter before setting up your server's application programs.

---

## Using Power Macintosh programs

Programs designed for Power Macintosh computers will provide improved performance for your server. However, to get the full benefit of this software, you need to know about two key issues—virtual memory and shared libraries.

### Virtual memory

Virtual memory is a feature of Macintosh computers that lets you use space on a hard disk as additional memory. This feature helps you run large applications when the server does not contain enough random-access memory (RAM). However, virtual memory will adversely affect the performance of your server application programs. *Do not turn on virtual memory with your Workgroup Server 6150.*

### Shared libraries

Power Macintosh programs use special files called *shared libraries*. These files help Power Macintosh programs to run more efficiently, and can be used by more than one Power Macintosh program simultaneously. Any necessary shared libraries are installed automatically in the System Folder when you install Power Macintosh programs.



Shared libraries are represented by icons like this.

If a Power Macintosh program requires a shared library and there is not enough memory available for the shared library, you'll see a message that the program could not be opened because there is not enough system memory available for the shared library. If this happens, quit programs not in use or install more memory in your server (see "Expanding Memory" in Chapter 3 for more information).

If a required shared library is missing, you'll see a message that the program could not be opened because the shared library could not be found. If this happens, follow the directions that came with your program to reinstall the program. If the shared library is still missing, contact the software program's manufacturer for assistance.

## Using older Macintosh programs

If you experience problems using an older Macintosh program, it may be incompatible with your Power Macintosh. You may be able to use your older program if you change the Memory Manager setting in your Memory control panel. Follow these steps:

- 1 Choose Control Panels from the Apple () menu and open the Memory control panel.
- 2 Turn off Modern Memory Manager.

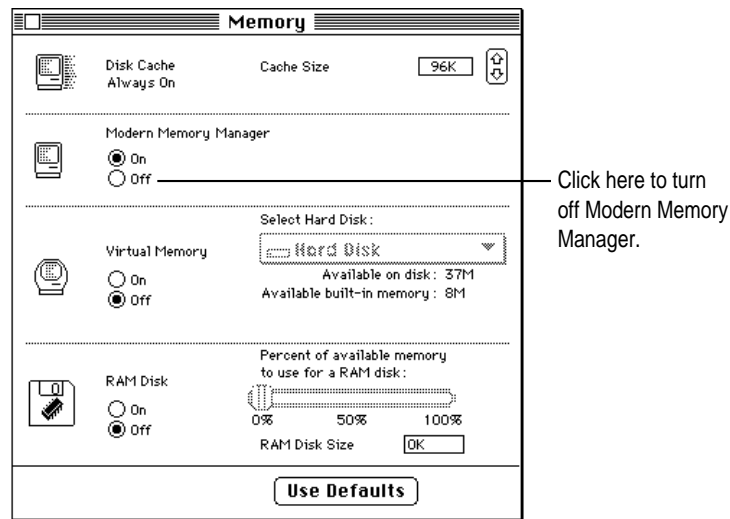

When you are finished using the program, open the Memory control panel again and turn Modern Memory Manager back on.

For best performance, contact the program's manufacturer for an upgrade.

## Using server application programs

Specific server application programs or services, such as AppleShare, AppleSearch, Apple Remote Access, or Apple RAID Software, may have been included with your server. Review the documentation that came with the software before you install these services; you may be required to perform special procedures that can affect your server system before you use a particular service. For instance, Apple RAID Software requires you to reinitialize the hard disks you want to use for storing server data.

**IMPORTANT** You can also use your Workgroup Server 6150 as a desktop personal computer to run personal application programs. Running such programs, however, may degrade the performance of your server application programs or network services.

### Setting the system time and date

As noted in Chapter 1, some server application programs require that your system clock be set correctly. If you need step-by-step instructions for setting the system time and date, see the “Setting Options” topic of Macintosh Guide, available in the Guide (📖) menu.

### Order of installing and starting programs

Though your server may have come with server application programs or network services, you may want to install additional software. Note that the order in which server application programs are installed and started is important. Be sure to review the documentation, especially product Read Me files, for all the server application programs you plan to use before installing and running them. Also, refer to the Workgroup Server Read Me file on your server system’s hard disk for the most up-to-date news about installing server application programs.

## Setting up your server to restart programs automatically

You can set the Workgroup Server 6150 to start server application programs (including network services) automatically whenever you start up the server or whenever the server automatically restarts after a temporary power outage.

To set up your server to restart server application programs automatically:

- 1 Create an alias for each program that you want the server to start automatically.**

You create an alias by selecting the icon of the program on the desktop and choosing Make Alias from the File menu.

- 2 Drag the aliases to the Startup Items folder, located in the System Folder on your startup disk.**

Macintosh computers and servers automatically open documents and programs (or their aliases) located in the Startup Items folder whenever the computer or server starts up.

*Note:* The server opens documents and programs located in the Startup Items folder in alphabetical or numerical order. Because the order in which server application programs are started may be important (as described in the program documentation), you may want to rename the aliases so that the programs start in the desired order. For example, you can insert a number at the beginning of a filename. The following figure shows a sample setup.

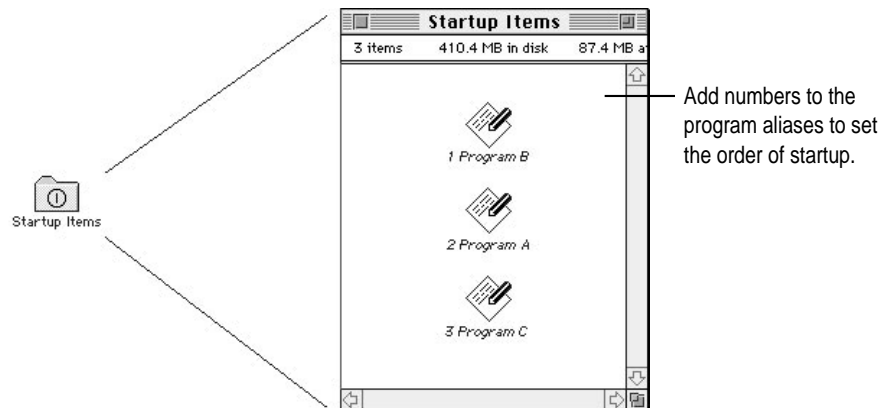

## Additional capabilities for your server system

You have the option to install two programs that provide new capabilities for your system software:

- PowerTalk, which provides built-in mail and collaboration services
- QuickDraw GX, which gives your computer more powerful printing capabilities

If you use your server as a personal computer and other users on your network have installed PowerTalk, you will find PowerTalk's features useful. When you install PowerTalk, you also install its on-screen help, available in the Guide (Ⓜ) menu.

**IMPORTANT** If you use the AppleShare Print Server with your server and you want to also use QuickDraw GX, be sure to see the AppleShare Read Me file.

You'll find Installers for these optional programs in the System Software Installers folder on the *Workgroup Server Software* CD-ROM disc.

**IMPORTANT** AppleScript, which allows you to automate many actions you perform repeatedly on your server, is already installed in your system. To review the available automated tasks, look in the Apple (🍏) menu. To learn how to create new scripts for your server, see the "Using AppleScript" documents in the AppleScript folder in the Apple Extras folder on your hard disk.

## Backing up your files

Making backup copies of important server files is good protection against possible damage to the originals. If a backup program was included with your server, be sure to use it (or another program which you prefer) to set up and schedule a regular, automatic backup of your files. You can also back up your files manually, by making copies on another hard disk or even on floppy disks, but such methods are less convenient.

# 5

## Troubleshooting

### When you run into trouble

While you're using your server, it's possible that you may experience a problem such as the pointer "freezing" on the screen, or you may see an error message or even a bomb icon. If you have trouble with your server, take a moment to review the solutions to common problems listed in this chapter.

*Note:* If you have a question or encounter a problem while your system is still running, you can also check the "Troubleshooting" topic of Macintosh Guide, available in the Guide (🔍) menu. For more information on the kinds of on-screen help available, see Appendix B, "Getting Help," in this guide.

### Take your time

When you see an error message, you don't have to take action immediately. The message stays on the screen until you click the OK button or turn off the server.

To help diagnose and correct the problem, gather as much information about the situation as you can before starting over:

- Make a note of exactly what you were doing when the problem occurred. Write down the message on the screen and its ID number (if any). Also list the programs you were using and the names of any items you know have been added to the System Folder since the system software was installed. This information will help a service person diagnose the problem. (It is helpful to keep a printed copy of the items in your System Folder. See instructions for printing a list of files in a window in the "Printing and Fonts" topic of Macintosh Guide, available in the Guide menu.)
  - Check the screen for any clues. Is a menu selected? What programs and document icons are open? Note anything else that seems relevant.
-

- If you were typing text and were not able to save it before the problem occurred, you can write down the parts of the text still visible on the screen so that some of your work will be easy to replace.
- Ask other Macintosh users about the problem you're having; they may have a solution for it.
- Find out what actions users were performing on the server (such as copying large files, launching programs on the server, or installing programs over the network).

If you need repair service, consult the service and support information that came with your server for instructions on how to contact an Apple-authorized service provider or Apple for assistance.

### Start over

Often you can eliminate a problem simply by clearing the server's memory and starting over.

If you can, save any open documents before restarting the server. If your system is "frozen" and does not respond to any input, or if you have a "bomb" message on the screen, saving may not be possible. You can try pressing ⌘-Option-Esc to quit the program in use when the problem occurred; if this works, you can then save the documents open in other programs before restarting.

To restart your server, try the following steps:

- 1 If you can, choose Restart from the Special menu or from the dialog box that's on-screen.**
- 2 If you can't choose Restart, hold down the ⌘ and Control keys while you press the Power On key.**

This key combination restarts the computer. (Use this key combination only if choosing Restart from the Special menu does not work.)

- 3 If nothing happens, look for the reset and interrupt switches on the back of your server and press the reset switch (the one marked with a triangle).**

Pressing the reset switch is like turning the power switch off and then on again. You will lose any work you haven't saved. (The interrupt switch is intended for use by programmers who have debugging software installed.)

**4** If pressing the reset switch does nothing, turn off your computer using the power switch, wait at least 10 seconds, then turn it on again.

**5** If the power switch doesn't turn off the computer, unplug your server.

If you suspect that the problem is with a peripheral device, such as a printer or external hard disk, turn off all devices for 10 seconds or more, then turn one on and restart the server. Continue shutting down the server and turning on another device until you encounter a device that causes the problem. You may need to have that device repaired.

## Solutions to common problems

This section describes the key symptom for a number of common problems followed by the steps you can take to solve each problem.

**IMPORTANT** Be sure to review the information in the *Workgroup Server Read Me* file located on your server's hard disk and on the *Workgroup Server Software* CD-ROM disc. This file contains late-breaking information and tips.

**You cannot turn on the server.**

See "Problems Turning On Your Server?" in Chapter 1.

**The server is turned on but the screen is dark.**

The server or the monitor is not getting power, a program has darkened the screen, or the monitor controls are not adjusted properly.

- If you use a screen-saver program, press a key or move the mouse to turn off the screen saver.
- Check the monitor's brightness and contrast controls and turn them up if necessary.
- Check that the monitor is turned on.
- Check that the power cord and monitor cable are plugged in and firmly connected to the server and that the electrical outlet has power. The power light on the server's front panel should be on.
- If you have more than one monitor, and only one is dark, check that it is set up correctly in the Monitors control panel.

**A disk icon with a blinking question mark appeared when you started your server.**

The blinking question mark indicates that your server cannot find system software. You may need to repair a damaged disk, or reinstall system software.



- Your server may be having a problem recognizing a SCSI device. Turn off external SCSI devices and restart.

If the server starts up after you turn off your SCSI devices, read the section on SCSI devices in Chapter 3 of this manual for information on connecting SCSI devices and assigning SCSI ID numbers.

- The system software is not installed on the startup hard disk, the system software is damaged, or the hard disk is not working properly. Start up your server with the *Workgroup Server Software* CD-ROM disc (see “Starting Up From the CD-ROM Drive” later in this chapter). Then refer to “Repairing a Damaged Disk” at the end of this chapter.

If repairing the disk doesn’t help, follow the instructions in “Reinstalling System Software” (later in this chapter).

**A disk icon with an X appeared and the floppy disk was ejected.**

Your server ejected a floppy disk, or a CD-ROM disc, that is not a startup disk.



- Wait a few seconds. The server should start up from its internal hard disk. Make sure you insert floppy disks only after the server has begun starting up.

**A “sad Macintosh” icon appeared and the server won’t start up.**

Your server cannot start up because of a problem with the system software or the server hardware.



- Eject any floppy disks (or CD-ROM discs) by turning off the server and then holding down the mouse button while you turn the server on again. Try starting up with a different startup disk (such as the *Workgroup Server Software* CD-ROM disc). If the “sad Macintosh” icon appears again, consult the service and support information that came with your server for instructions on how to contact an Apple-authorized service provider or Apple for assistance.

**You see an error message at startup telling you that the system will use the LocalTalk port.**

If you will not be using an Ethernet network, you need to change the setting in the Network control panel from EtherTalk to the appropriate network. See “If You Need to Switch the Network Connection” in Chapter 2.

**The server’s clock keeps time inaccurately.**

Your server has a clock that runs continuously. When the computer is turned off, a battery keeps the clock running. If your clock begins to keep time inaccurately, have your Apple-authorized service provider replace the battery.

**The server starts up from the wrong hard disk, or the hard disk icon does not appear on the desktop.**

The startup disk may be slow to start up. Restart the server.

During startup, your server’s operating system finds and mounts attached SCSI devices that are up and running within 20 seconds. Some very large hard disk drives (such as 2-gigabyte drives) may take longer than 20 seconds to come up to speed and therefore may not be recognized by the operating system when the server is first turned on. Restarting the server enables your system to find these devices because they will be able to reach full operating speed during the second startup cycle.

If you still have a problem, try the following:

- If the hard disk is external, make sure it is turned on and its cable is connected firmly and properly terminated; then restart the server.
- Check the ID numbers of all SCSI equipment connected to your server. See the information on SCSI devices in Chapter 3 of this book.
- If the hard disk is your startup disk, start up your server with the *Workgroup Server Software* CD-ROM disc (see “Starting Up From the CD-ROM Drive” later in this chapter). Then see “Repairing a Damaged Disk” (later in this chapter). If repairing the disk doesn’t help, follow the instructions in “Reinstalling System Software” (also later in this chapter).

**IMPORTANT** If the hard disk in question has been initialized for use with RAID volumes, you won’t see an icon for it on the desktop until you create at least one RAID volume on that disk.

**Icons do not appear correctly on your screen.**

You need to “rebuild the desktop”—a process that helps your server keep track of files and folders on your hard disks.

- Hold down the Option and ⌘ (Command) keys while starting up your server. Keep holding down the keys until you see a message asking whether you want to rebuild the desktop. Click OK.

**Your server can’t read a floppy disk.**

If you see a message that a floppy disk is unreadable, try one of the following:

- Insert the disk again—sometimes that’s all it takes.
- If the disk has never been used, you may simply need to initialize it. See the instructions for preparing a disk listed in the “Files” topic of Macintosh Guide, available in the Guide menu.
- Insert the disk in another computer’s disk drive. If that computer can use the disk, make a copy of the data and put the copy on a different floppy disk.
- You may need to repair the disk because it is damaged. For information on testing and repairing disks, see “Repairing a Damaged Disk” later in this chapter.

If you are trying to use a DOS disk:

- The disk may have been formatted incorrectly on a DOS computer. On DOS computers it's possible to format a standard double-sided disk in a high-density (1440K) format, and vice versa. Disks formatted this way cannot be read by a Macintosh computer.

When formatting disks on a DOS computer, always format standard double-sided disks in the 720K format. Always format high-density disks in the 1440K format.

If a disk has been formatted incorrectly, use a DOS computer to copy its contents onto another disk that has been properly formatted.

**The pointer doesn't move when you move the mouse.**

The mouse is not connected properly, or its signals are not reaching the server, or there is a software error.

- Turn off the server by using the power switch, check that the mouse cable is connected properly, then restart the server.
- Clean the mouse (see Appendix A, "Safety, Maintenance, and Health Information").
- If you have another mouse or pointing device, try connecting and using it. (Turn off the server first.) If it works, there is probably something wrong with your mouse.
- Restart the server with a different startup disk (such as the *Workgroup Server Software* CD-ROM disc). If the mouse works, reinstall system software on your startup disk.
- If the problem recurs, it may be due to an incompatible program. Make sure that all programs, desk accessories, and system extensions you're using are compatible with the system software.

If none of these procedures solves the problem, consult the service and support information that came with your computer for instructions on how to contact an Apple-authorized service provider or Apple for assistance.

**Typing on the keyboard produces nothing on the screen.**

The insertion point hasn't been set, no text is selected, an application program is not active, the keyboard is not connected properly, the keyboard's signals are not reaching the server, or there is a software error.

- Make sure the program you want to use is the active program.
- Place the pointer in the active window and click to set an insertion point or drag to select text (if applicable).
- Turn off the server by using the power switch, then check that the keyboard cable is connected properly at both ends.
- Turn off the server, then connect the keyboard cable to the other ADB port (marked with the  icon) on the keyboard. (You may have to unplug the mouse to do this.) If your keyboard cable is connected to your monitor, connect it to another ADB port on the monitor or directly to the server's ADB port (on the back of the server). If typing still doesn't work, the problem is most likely in the keyboard itself.
- If you have access to another keyboard, try using it instead. (Turn off the server before connecting it.)
- Restart the server with a different startup disk (such as the *Workgroup Server Software* CD-ROM disc). If this solves the problem, reinstall system software on your startup disk.

If none of these procedures solves the problem, consult the service and support information that came with your computer for instructions on how to contact an Apple-authorized service provider or Apple for assistance.

**A dialog box with a “bomb” icon appears.**

Your system has a software problem.

- Write down what you were doing when the dialog box appeared, and write down the number on the message, if there is one.
- Restart your server (see “Start Over” earlier in this chapter). Most software problems are temporary and restarting usually corrects the problem.

- If the problem recurs, check the startup disk and program you are using when the message appears. Make sure that all programs, desk accessories, and system extensions you're using are compatible with the system software. Reinstalling the system software may correct the problem.
- Sometimes incompatible system extensions or control panels can cause system software problems. To see if this is the problem, use the Extensions Manager control panel to turn off individual extensions and then restart the server. For information on using this control panel to manage system extensions, see the "Setting Options" topic of Macintosh Guide, available in the Guide menu. If turning off these programs doesn't correct the problem, you may need to reinstall system software.

**You can't start your program or it quits unexpectedly. When you try to open a program, you see a message that not enough memory is available.**

The program needs more memory or the server ran out of memory.

- Quit the programs that you have open and then open the program you want to use, or restart your server.
- Use the program's Info window to give it more memory. For more information see the instructions for making more memory available in the "Working with Programs" topic of Macintosh Guide, available in the Guide menu.

**You see a message that your application program can't be opened because a file can't be found.**

Power Macintosh programs use special files called *shared libraries*. Any necessary shared libraries should be installed automatically when you install Power Macintosh programs.

- Follow the directions that came with your program to reinstall the program. If the shared library is still missing, contact the software program's manufacturer for assistance.

**You experience problems using an older Macintosh program.**

Some older Macintosh programs are not completely compatible with the Power Macintosh computers.

- Open the Memory control panel and turn off Modern Memory Manager. For more detailed instructions, see "Using Older Macintosh Programs" in Chapter 4 of this guide.

**You experience problems using a document from a DOS computer.**

If you can't open a DOS or Windows document using a Macintosh program, try the following:

- Open the document from within the program by using the Open command in the program's File menu.
- Use the PC Exchange control panel to change the document's type to one that can be opened by the program. See the information on setting up your Macintosh to use DOS files in the "Using DOS Files and Disks" topic of Macintosh Guide, available in the Guide menu.

If a DOS document is displayed incorrectly, or you see strange codes or characters in the document:

- Your application program may have special procedures for opening and saving documents with different file formats. See the information that came with your application program.
- Try opening the document in another program.

*Note:* Some characters that can be displayed on the server are not accurately displayed on DOS computers.

**You see a message that an application program can't be found.**

The following dialog box appears if you try to open a document created using software that is not on your hard disk.

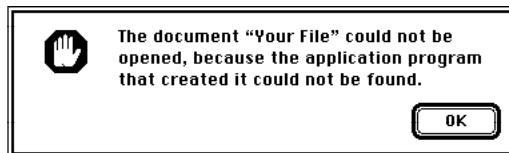

Normally, you see this message if you try to open a document that came from another computer with software that is different from yours.

- Some documents can be opened by more than one application program. Try starting a program that you think might be able to open the document; then choose the Open command from the program's File menu to try to open the document. (Or drag the document to the program's icon. If the program can open the document, the program's icon highlights.)
- Purchase and install the correct software to use the document, or find out if the original owner of the document can convert it to a form that one of your programs can use.
- Don't try to open the files in your System Folder. Most of the System Folder files are used by your server for internal purposes, and are not intended to be opened.
- Rebuild your desktop by holding down the Option and ⌘ (Command) keys while starting up your server. Keep holding down the keys until you see a message asking whether you want to rebuild the desktop. Click OK.
- The application program itself may be damaged. Try reinstalling it.
- If the document is from a DOS computer, use the PC Exchange control panel. See the information on setting up your Macintosh to use DOS files in the "Using DOS Files and Disks" topic of Macintosh Guide, available in the Guide menu.

**Your print server is not functioning properly.**

You may not be using the correct version of the LaserWriter printer driver software. If you are running the AppleShare Print Server, you need to use version 7.2 of the LaserWriter printer software, which is preinstalled on the server. For more information, see the Read Me file for AppleShare.

**Your can't see files on your CD-ROM drive.**

If the drive in question is external, be sure that it is properly connected and terminated. See the section "Connecting Hard Disks and Other SCSI Devices" in Chapter 3.

There may be a problem with the CD-ROM drive software in your system and you need to reinstall that software. See the section "If There's a Problem With Your CD-ROM Drive Software" later in this chapter.

## When you need to reinstall system software

System software is the set of programs and other files that your server uses to start itself up, keep track of your files, and run the application programs you use. This software is kept in a folder called the System Folder. When you turn on your server, it looks for a startup disk, which is a disk that contains the system software. The startup disk is usually the hard disk that's inside your server, though another hard disk, floppy disk, or CD-ROM disc can also be a startup disk.

Your server came with all the necessary system software installed on your hard disk. Unless a problem develops later, you don't need to reinstall the software. If a problem with your system software develops, you may see this icon in the middle of the screen:



If you see this icon, start up your server with the *Workgroup Server Software* CD-ROM disc, as described in the section “Starting Up From the CD-ROM Drive ” later in this chapter. Then refer to “Repairing a Damaged Disk” at the end of this chapter for information on testing and repairing disks.

If repairing the disk doesn't help, use the following instructions to start up your server and reinstall system software.

### Reinstalling system software

When you have determined that you need to reinstall system software, you need to shut down your server and then start it up with another disk and use the Installer program to reinstall the system software on your server's hard disk. Follow the steps provided in this section.

**IMPORTANT** If you've made a backup copy of your system software, you should reinstall your system software from your backup media. If you used a backup program to make the copy, see the documentation that came with your backup program.

### Starting up from the CD-ROM drive

You can use the *Workgroup Server Software* CD-ROM disc to start up your server from the built-in CD-ROM drive (even if your startup disk is damaged).

- 1 **With your server turned on, place the *Workgroup Server Software* CD-ROM disc in the CD-ROM drive's tray with the label facing up, and close the tray.**
- 2 **Choose Restart from the Special menu.**
- 3 **Immediately press and hold down the "C" letter key. Release the key after the server starts up.**

**IMPORTANT** For best performance, start up your server from its internal hard disk. (You can check that the internal hard disk is selected in the Startup Disk control panel.) Use the *Workgroup Server Software* CD-ROM disc only as a temporary startup system.

### Starting up from a floppy drive

If you need to do so, you can use floppy disks that contain system software to start up your server. Use the disks you created with your backup program or by copying system software from the *Workgroup Server Software* CD-ROM disc. See the section "Creating Startup Floppy Disks" later in this chapter for more information.

- **Insert the disk named *Install Me First* into the floppy drive and start up your server.**

*Note:* Make sure you've labeled your disks exactly as the Disk Copy program names them, as described in the section "Creating Startup Floppy Disks" later in this chapter.

An Installer screen opens automatically to let you reinstall system software on your hard disk.

*Note:* If you want to start up your server from a floppy disk without installing system software, use the disk named *Disk Tools*.

## About using the Installer program

Before you use the Installer, you need to start up your server by following the instructions in either “Starting Up From the CD-ROM Drive” or “Starting Up From a Floppy Drive” earlier in this chapter.

How you start using the Installer depends upon where it is located:

- If you started up from the *Workgroup Server Software* CD-ROM disc, open the folder named System Software Installers and review the instructions in the Read Me file before using the Installer programs there.
- If you started up from the floppy disk named *Install Me First*, the Installer opens automatically. Depending on the version of system software on the floppy disk, you may also need to use another Installer to do a system update after the basic system installation.

After you open the Installer, using it to install system software involves the following steps:

- 1 In the Welcome dialog box that appears, click Continue.



The version of system software you install may be later than the one shown in this example.

- 2 Check that the destination disk indicated in the Installer is the one on which you want to install system software.

If not, click the Switch Disk button until the correct disk name appears.

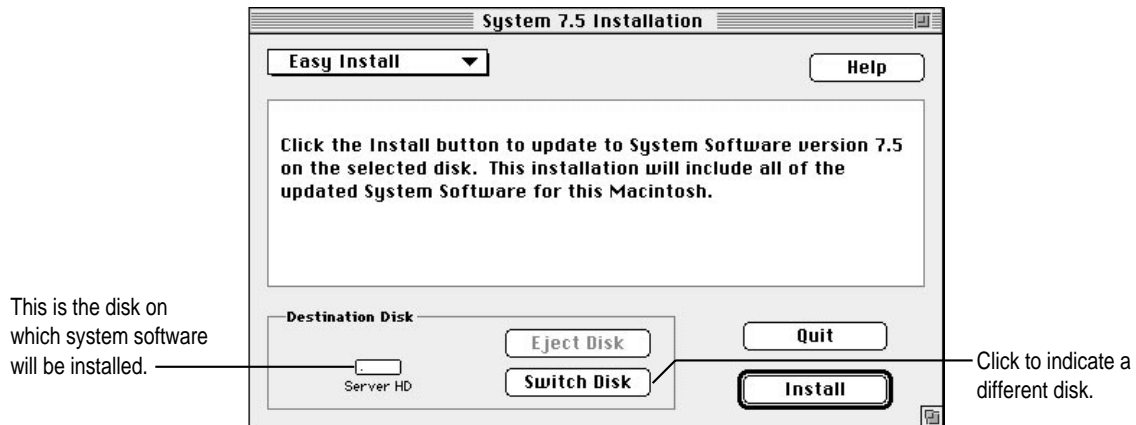

*Note:* If you are using the Installer on a hard disk that doesn't have system software, the explanatory text on-screen will be slightly different from what's shown in this example.

- 3 Click Install.

The Easy Install status box appears and keeps you informed of progress during installation.

If you are installing from floppy disks, follow the instructions asking you to insert different disks.

- 4 If you see a message telling you that you need to restart your system, click Restart. Otherwise, click Quit.

If a message reports that installation was not successful, try installing again. (Follow the instructions on the screen.)

That's it. You've installed Macintosh system software on your startup disk.

*Note:* The Installer also has a "custom" feature that lets you install or remove one or more items. See the Installer's Help information for more details.

## Creating startup floppy disks

You can create Macintosh system software floppy disks from the *Workgroup Server Software* CD-ROM disc. This allows you to have a backup copy of the system software from which you can start up the server and reinstall the system software. You need to use the Disk Copy program to make a copy of the system software. (Dragging system software files to floppy disks does not work because the Installer expects the files to be in certain places on the floppy disks.)

To copy the software, you'll need eleven high-density (1.4 megabyte [MB]) floppy disks.

- 1 **Insert the *Workgroup Server Software* CD-ROM disc into the CD-ROM drive.**
- 2 **Open the folder named "Disk Images" and locate the Disk Copy icon.**

You may need to scroll the window to see the icon.

- 3 **Double-click the Disk Copy icon to start the program.**
- 4 **Click anywhere on the screen to remove the explanatory dialog box.**

The Disk Copy window appears.

- 5 **In the window, click Load Image File.**

A dialog box appears, in which you can select the disk image that you want to copy. Each image file contains the software for one system software disk.

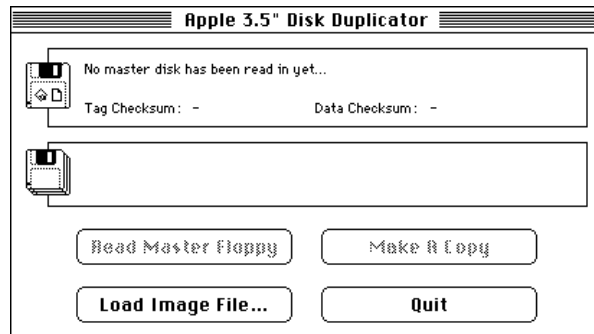

**6 Click the name of a disk image; then click Open.**

In a few moments a message appears near the top of the window, indicating that the disk image has been loaded.

**7 Click Make A Copy.**

**8 When you see a message telling you to insert a disk, insert a floppy disk.**

If the disk already contains information, you're asked whether you want to replace the contents of the disk. Click Duplicate if you want to erase the information on the disk and replace it with a copy of system software. Otherwise, eject the disk and insert a different disk.

**9 When you see a message telling you that the disk was duplicated successfully, click Load Image File to copy another disk image or click Quit to leave the program.**

The program ejects the disk when it has copied the image.

**10 Repeat steps 6 through 9 for each disk image until you have copied all the disk image files.**

Store the backup disks in a safe place.

*Note:* It's a good idea to label the disks exactly as they are named by the Disk Copy program. That way, if you need to start up from a floppy disk and reinstall system software, you can easily follow the directions in "Starting Up From a Floppy Drive," earlier in this chapter.

## What to do if your server's performance decreases

If you notice a decrease in your server's speed and general performance after adding special software (a control panel, a system extension, or a custom utility), it may be because your special software does not work well with Power Macintosh computers.

To see if this is the problem, use the Extensions Manager control panel to turn off individual programs and extensions, one at a time, and then restart the server. (For information on using the Extensions Manager control panel, see the "Setting Options" topic of Macintosh Guide, available in the Guide menu.) If the computer performs better when a special program or extension is removed, contact the software's manufacturer for information or an upgrade.

If you still do not notice an improvement after removing all special programs, try doing a “clean” installation of system software, as described next.

## Doing a clean installation of system software

Performing what is commonly called a “clean” installation of system software involves repairing any damage to your startup disk and installing new versions of system software and disk drive software. To do this, you must start up your server from the *Workgroup Server Software* CD-ROM disc. There are a number of steps involved; here’s an overview of the entire process:

- Use the Disk First Aid program to inspect and repair your startup disk.
- Use Apple HD SC Setup to update the startup disk drive software.
- Use a special feature of the Installer to do the clean installation.

**WARNING** If your startup disk has been formatted for use with Apple RAID Software, do not use the following instructions for doing a clean installation. See the *Apple RAID Software Administrator’s Guide* for information about repairing disks and installing system software on disks containing RAID volumes.

After the clean installation you can experiment with any special software you used with the previous system software to see if you can use it without decreasing the server’s performance.

**IMPORTANT** Do a clean installation of system software only if you are sure it’s acceptable to remove any special control panels, extensions, or custom utilities you have added to your System Folder. These items will not work when moved out of the System Folder.

*Note:* You may have to reinstall some server application programs (including network services) if you do a clean installation; see your server application program documentation for details.

Follow these steps to do a clean installation:

- 1 **Start up your server from the *Workgroup Server Software* CD-ROM disc.**

If you need instructions, see the section “Starting Up From the CD-ROM Drive” earlier in this chapter.

- 2 **Open the Utilities folder on the *Workgroup Server Software* disc, then double-click the Disk First Aid icon.**



Disk First Aid

- 3 **In the Disk First Aid window, click the icon of the server’s hard disk.**

Disk icons appear in a box at the top of the Disk First Aid window.

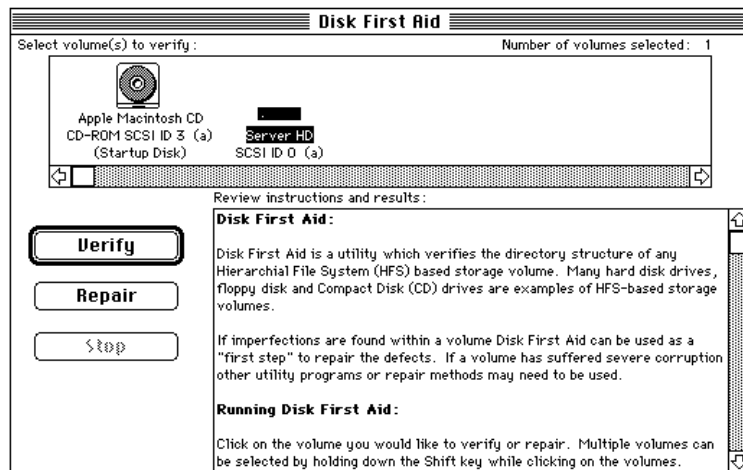

- 4 **Click Repair to begin testing and, if necessary, repairing the startup disk.**
- 5 **When the program is finished, choose Quit from the File menu.**
- 6 **Double-click the Apple HD SC Setup icon.**



Apple HD SC Setup

**WARNING** If your startup disk has been formatted for use with Apple RAID Software, do not use HD SC Setup to update the disk. See the *Apple RAID Software Administrator's Guide* for information about repairing disks containing RAID volumes.

- 7 Click **Update** to replace the existing startup disk drive software with a new version.
- 8 When the startup disk software is updated, choose **Quit** from the **File** menu.
- 9 Make sure that at least 20 MB of disk space is available on the startup disk.  
If needed, delete unnecessary files until you have 20 MB of space available.
- 10 Open the **Installer** program in the **System Software Installers** folder on the *Workgroup Server Software* CD-ROM disc and click **Continue** when the **Welcome** screen appears.
- 11 If the destination disk named in the **Installer** screen is not the hard disk on which you want to do the clean installation, click **Switch Disk** until the correct name appears.
- 12 To start the clean installation process, press the **Shift-⌘-K** key combination.
- 13 In the dialog box that appears, click the **Install New System Folder** button and click **OK**.  
The dialog box disappears, and the **Install** button in the **Installer** screen changes to **Clean Install**.
- 14 Click **Clean Install** and follow any instructions that the **Installer** displays.
- 15 If a message reports that installation was not successful, repeat the clean installation procedure.
- 16 When you see a message reporting that the installation was successful, if you installed software on the startup disk, click **Restart**; otherwise, click **Quit**.
- 17 Copy any special software items from the **Previous System Folder** (automatically created by the **Installer**) to the clean **System Folder** one item at a time, restarting the server after copying each item.

If you find that any of your special software items (control panels, system extensions, or custom utilities) causes problems or degrades your server's performance, contact the software's manufacturer for assistance or an upgrade.

**IMPORTANT** Be very careful not to *replace* (copy over) any of the new system files in the **System Folder** with files from the **Previous System Folder**.

## If there's a problem with your CD-ROM drive software

Your built-in CD-ROM drive requires special software, which is already installed on your hard disk. If you experience occasional problems using your CD-ROM drive, try reinstalling the server's multimedia software, which includes CD-ROM and QuickTime software.

**IMPORTANT** If you cannot use your server's CD-ROM drive, use a set of system software floppy disks to restart your system and reinstall the CD-ROM drive software. See "Starting Up From the Floppy Drive" earlier in this chapter. (If necessary, you can use the *Workgroup Server Software* CD-ROM disc on another computer system to create a set of startup floppy disks.)

Follow these steps to use the *Workgroup Server Software* CD-ROM disc to reinstall CD-ROM drive software on your server's startup disk:

- 1 Place the disc in the CD-ROM drive's tray with the label facing up, and close the tray.**  
The *Workgroup Server Software* CD-ROM disc's window opens automatically.
- 2 Open the System Installer program located in the System Software Installers folder.**  
If you haven't already done so, check the Read Me file in that folder for any specific instructions on using the Installer programs available.
- 3 In the Installer Welcome dialog box that appears, click Continue.**
- 4 Check that the destination disk named in the dialog box is the server's startup disk.**  
If not, click the Switch Disk button until the correct disk name appears.
- 5 Choose Custom Install from the pop-up menu.**
- 6 Click to select the Multimedia Software checkbox and then click Install.**  
The Multimedia Software option provides the CD-ROM drive software and QuickTime software—it's recommended that you reinstall both when updating your system.
- 7 When you see a message reporting that installation was successful, click Restart.**  
Your CD-ROM drive should now operate normally. (If a message reports that installation was not successful, follow the instructions on the screen to try installing again.)

## Repairing a damaged disk

Disks can become damaged by repeated use and handling.

If you see a message reporting that a disk is damaged or unreadable, you may need to repair the disk.

**WARNING** If the damaged disk has been formatted for use with Apple RAID Software, see the Apple *RAID Software Administrator's Guide* for information about repairing disks that contain RAID volumes.

### Try these suggestions first

If you can't start up from a hard disk or you don't see the hard disk icon on the desktop, try the following:

- If the hard disk is internal, shut down your Macintosh, wait at least 10 seconds, and then turn it on again.
- If the hard disk is external, make sure that it is turned on and that its cable is connected firmly; then restart the Macintosh.
- If the hard disk is your startup disk, start up with a different startup disk. If the hard disk's icon appears on your desktop, reinstall system software on the hard disk (see "Reinstalling System Software" earlier in this chapter).
- Check the ID numbers of all SCSI equipment connected to your computer. Each device must have a unique ID number (the computer itself has the ID number 7, and the internal hard disk has the number 0). Also check that the chain of devices is terminated properly. For information on setting SCSI ID numbers and terminating a SCSI chain, see Chapter 3 of this guide or the manuals that came with your SCSI equipment.
- Test the disk by following the instructions in the next section.

## How to test a hard disk

You can test an Apple SCSI hard disk with the Apple HD SC Setup program, which is on the *Workgroup Server Software* CD-ROM disc.

- 1 **Start up your server from the *Workgroup Server Software* CD-ROM disc.**  
If you need instructions, see “Starting Up From the CD-ROM Drive” in the section “Reinstalling System Software” earlier in this chapter.
- 2 **Open the *Workgroup Server Software* CD-ROM disc icon and then open the Utilities folder.**
- 3 **Open the Apple HD SC Setup icon.**



Apple HD SC Setup

- 4 **Click Drive until the name of the disk you want to test appears at the bottom of the dialog box.**

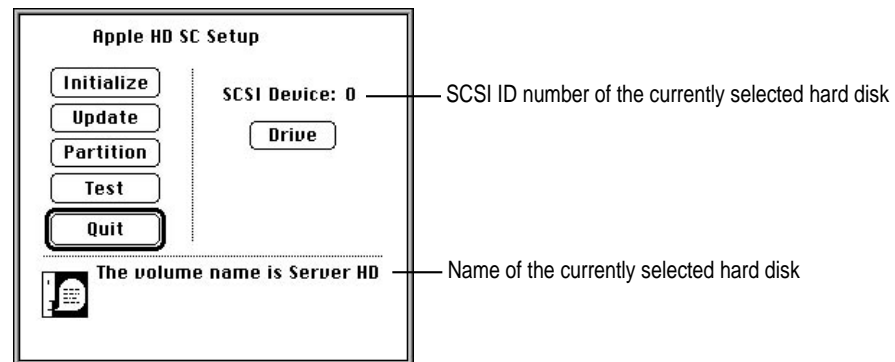

- 5 **Click Test.**
- 6 **When a message tells you that testing is complete, click Quit.**

If the test reveals a problem, you may be able to correct it by using Disk First Aid or another disk repair program (see the instructions in the next section). If you cannot correct the problem you may need to initialize the disk (again, using Apple HD SC Setup) and reinstall system software (see “Reinstalling System Software” earlier in this chapter). If necessary, consult an Apple-authorized service provider for assistance.

## How to repair a hard disk or floppy disk

You can repair some types of disk damage by using the Disk First Aid program, which is included on the *Workgroup Server Software* CD-ROM disc.

**WARNING** If the damaged disk has been formatted for use with Apple RAID Software, see the *Apple RAID Software Administrator’s Guide* for information about repairing disks that contain RAID volumes.

- 1 If you are repairing your startup disk, start up your server from the *Workgroup Server Software* CD-ROM disc; otherwise, just insert the CD-ROM disc.

If you need instructions for starting up from the *Workgroup Server Software* CD-ROM disc, see “Starting Up From the CD-ROM Drive” in the section “Reinstalling System Software” earlier in this chapter.

- 2 Open the *Workgroup Server Software* CD-ROM disc icon and then open the Utilities folder.
- 3 Open the Disk First Aid icon.



Disk First Aid

The Disk First Aid window opens. Disk icons appear in a box at the top of the window.

- 4 Click the icon of the disk you want to test.

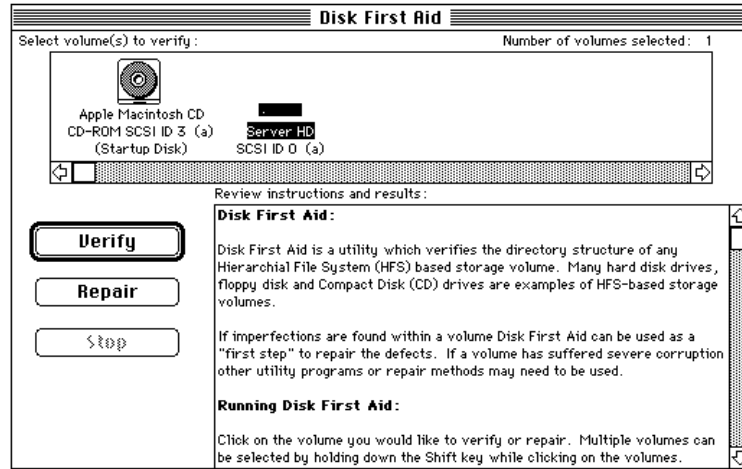

- 5 Click Repair to begin testing and repairing the disk.
- 6 When testing and repair are finished, choose Quit from the File menu.

### If Disk First Aid cannot correct the problem

- Try repairing the disk again. Sometimes repeating the process corrects the problem.
- Use another disk repair or recovery program. Some disk repair programs let you recover information from a damaged disk.
- Consult a computer repair specialist for help.
- Once you have recovered all the information you can, erase (reinitialize) the disk. If initialization doesn't work, discard the damaged disk (if it's a floppy disk), or take it to your Apple-authorized service provider for repair (if it's a hard disk).



# Appendix A Safety, Maintenance, and Health Information

## Important server safety instructions

For your own safety and that of your equipment, always take the following precautions.

Turn off the server and disconnect the power plug (by pulling the plug, not the cord) if any of the following conditions exists:

- The power cord or plug becomes frayed or otherwise damaged.
- You spill something into the case.
- Your server is exposed to rain or any other excess moisture.
- Your server has been dropped or the case has otherwise been damaged.
- You suspect that your server needs service or repair.
- You want to clean the case (use only the recommended procedure described later in this section).

For additional safety:

- If you ever need to remove the cover of your server, replace it before you use the server.
  - Never turn on your server with any of the internal parts removed.
  - Never turn on your server with any parts of the external closure removed.
-

Be sure that you always do the following:

- Keep your computer away from sources of liquids, such as wash basins, bathtubs, shower stalls, and so on.
- Protect your computer from dampness or wet weather, such as rain, snow, and so on.
- Read all the installation instructions carefully before you plug your computer into a wall socket.
- Keep these instructions handy for reference by you and others.
- Follow all instructions and warnings dealing with your system.

**WARNING** Electrical equipment may be hazardous if misused. Operation of this product, or similar products, must always be supervised by an adult. Do not allow children access to the interior of any electrical product and do not permit them to handle any cables.

To clean the case, do the following:

- 1 Turn off the computer and then disconnect the power plug. (Pull the plug, not the cord.)**
- 2 Wipe the surfaces lightly with a clean, soft cloth dampened with water.**

**WARNING** If you have a problem with your server and nothing in the manuals that came with the server solves the problem, consult the service and support information that came with your server for information on how to contact an Apple-authorized service provider or Apple for assistance.

## Handling your computer equipment

Follow these guidelines for handling your server and its components:

- When setting up your server, place components on a sturdy, flat surface, and carefully follow all setup instructions.
- When connecting or disconnecting a cable, always hold the cable by its connector (the plug, not the cord).
- Turn off your server and all its components before connecting or disconnecting any cables to add or remove any component. Failure to do so could seriously damage your equipment.
- Never force a connector into a port. If the connector and port do not join with reasonable ease, they probably don't match. Make sure that the connector matches the port and that you have positioned the connector correctly in relation to the port.
- Take care not to spill any food or liquid on the server, keyboard, mouse, or other components. If you do, turn your server off immediately and unplug it before cleaning up the spill. Depending on what you spilled and how much of it got into your equipment, you may have to bring your equipment to an Apple-authorized service provider.
- Protect the server and its components from direct sunlight and rain or other moisture.
- Keep all ventilation openings clear and unobstructed. Without proper air circulation, components can overheat, causing damage or unreliable operation.

## Handling the monitor

Follow these procedures for handling a monitor:

- Turn down the screen brightness control if you leave the server turned on for extended periods. If the brightness is not turned down, the image on the screen could “burn in” and damage the screen.

You can also use a “screen-saver” program, which dims or varies the image on the screen when the server has been idle for a specified period of time.

These programs are available from independent suppliers and user groups.

- Make sure that the ventilation openings on the server and the monitor are clear and unobstructed.
- Some large monitors cannot safely be placed on top of the server. Check the instructions that came with the monitor for setup information.
- If there is interference on the monitor’s screen or on a television or radio near your server, move the affected equipment farther away.

## Handling the keyboard

Take care not to spill any liquid on the keyboard. If you do, turn off your server immediately.

- If you spill liquid that is thin and clear, unplug the keyboard, turn it upside down to let the liquid drain out, and let it dry for 24 hours at room temperature. If, after you take these steps, the keyboard doesn’t work, take it to an Apple-authorized service provider for repair.
- If you spill liquid that is greasy, sweet, or sticky, unplug the keyboard and take it to an Apple-authorized service provider for repair.

## Handling floppy disks

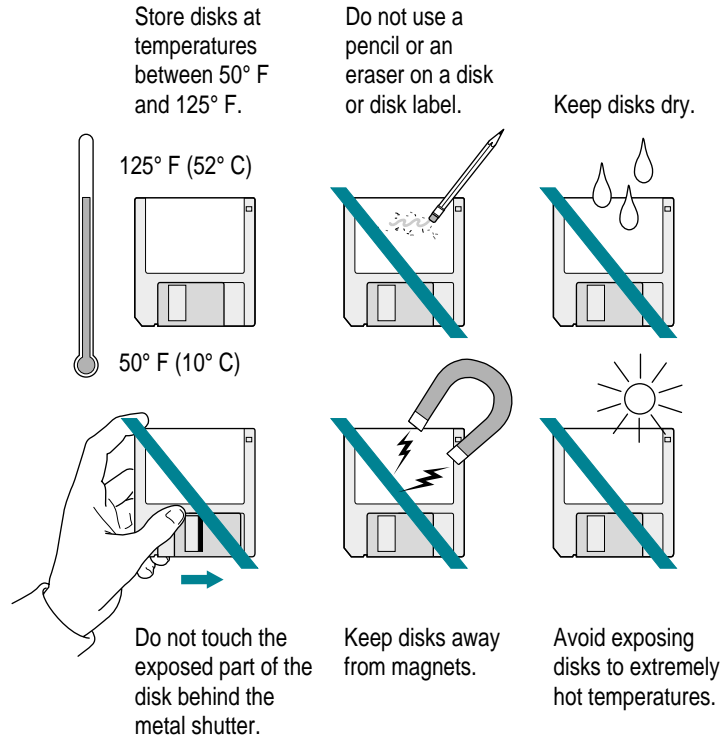

## Ejecting a disk

For instructions on ejecting a floppy disk, a CD-ROM disc, or a removable media disk, see the “Disks” topic of Macintosh Guide, available in the Guide menu.

## If you can't eject a floppy disk

If you can't eject a floppy disk in the usual way, try the following in order:

- Hold down the ⌘ (Command) and Shift keys and press the number 1 key on your keyboard to eject a disk in the internal disk drive.
- Shut down the server. If the disk isn't ejected, then hold down the button on your mouse or other pointing device while you restart the server.

- Locate the small hole near the disk drive's opening, and carefully insert the end of a large straightened paper clip into it. Push gently until the disk is ejected. Do not use excessive force.

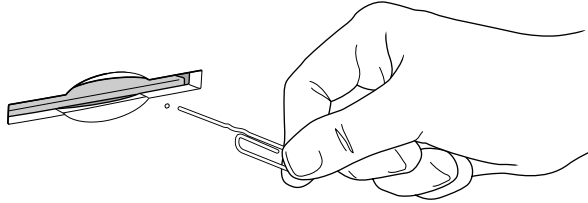

If nothing works, take the server or disk drive to your Apple-authorized service provider to have the disk removed.

### Power supply

The power supply in your server is a high-voltage component and should not be opened for any reason, even when the server is off. If the power supply needs service, contact your Apple-authorized dealer or service provider.

## Cleaning your equipment

Follow these general rules when cleaning the outside of your server and its components:

- Use a damp, soft, lint-free cloth to clean the server's exterior. Avoid getting moisture in any openings.
- Don't use aerosol sprays, solvents, or abrasives.

### Cleaning the server case

To clean the case, do the following:

- 1 Turn off the server and disconnect the power plug. (Pull the plug, not the cord.)
- 2 Wipe the surfaces lightly with a clean, soft cloth dampened with water.

## Cleaning the monitor

To clean the screen, put household glass cleaner on a soft cloth and wipe the screen. Don't spray the cleaner directly on the screen, because the liquid might drip into the monitor or server.

## Cleaning the mouse

The mouse contains a small ball that must roll smoothly for the mouse to work properly. You can keep this ball free of dirt and grease by using the mouse on a clean, lint-free surface and cleaning it occasionally.

You need a few cotton swabs and a clean, soft, lint-free cloth.

- 1 Turn off your server.
- 2 Turn the mouse upside down and turn the plastic ring on the bottom counterclockwise to disengage it.

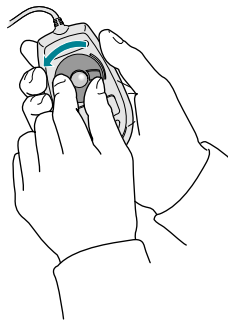

If you have an older mouse, you may need to press the plastic ring (rather than turn it) to disengage it.

- 3 Turn the mouse right side up with one hand and catch the ring and the ball with your other hand.

- 4 Clean the three small rollers inside the mouse with a cotton swab moistened with water.**  
Rotate the rollers to clean all around them.

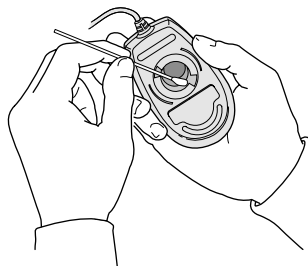

- 5 Wipe the mouse ball with a clean, soft, dry, and lint-free cloth.**
- 6 If necessary, wash the mouse ball with warm soapy water (use a mild soap such as a dishwashing liquid) and then dry the mouse ball thoroughly.**
- 7 Gently blow into the mouse case to remove any dust that has collected there.**
- 8 Put the ball and the ring back in place.**

Your mouse should roll smoothly across your mouse pad or desk. If it doesn't, repeat these instructions carefully.

## Health-related information about computer use

Muscle soreness, eye fatigue, and other discomforts and injuries sometimes associated with using computers can occur from performing any number of activities. In fact, misuse of the same muscles during multiple activities can create a problem that might not otherwise exist. For example, if you engage in nonwork activities that involve repetitive stress on the wrist—such as bicycling—and also use your computer keyboard improperly, you may increase your likelihood of developing wrist problems. Some individuals are at greater risk of developing these problems because of their health, physiology, lifestyle, and general exposure to stress. Work organization and conditions, such as workstation setup and lighting, also play a part in your overall health and comfort. Preventing health problems is a multifaceted task that requires careful attention to the way you use your body every hour of every day.

The most common health effects associated with using a computer are musculoskeletal discomfort and eye fatigue. We'll discuss each area of concern below. For information about electric and magnetic emissions, look in the reference material that came with your computer.

### **Musculoskeletal discomfort**

As with any activity that involves sitting for long periods of time, using a computer can make your muscles sore and stiff. To minimize these effects, set up your work environment carefully, using the guidelines that follow, and take frequent breaks to rest tired muscles. To make working with your computer more comfortable, allow enough space in your work area so that you can change position frequently and maintain a relaxed posture.

Another type of musculoskeletal concern is repetitive stress injuries (RSIs), also known as cumulative trauma disorders (CTDs). These problems can occur when a certain muscle or tendon is repeatedly overused and forced into an unnatural position. The exact causes of RSIs are not totally understood, but in addition to awkward posture, such factors as the amount of repetition, the force used in the activity, the individual's physiology, workplace stress level, and lifestyle may affect the likelihood of experiencing an RSI.

RSIs did not suddenly arise when computers were invented; tennis elbow and writer's cramp, for example, are two RSIs that have been with us for a long time. Although less common than other RSIs, one serious RSI discussed more often today is a wrist problem called carpal tunnel syndrome, which may be aggravated by improper use of computer keyboards. This nerve disorder results from excessive pressure on the median nerve as it passes through the wrist to the hand.

This section offers advice on setting up your work area to enhance your comfort while you use your computer. Since the effects of repetitive movements associated with using a computer can be compounded by those of other work and leisure activities to produce or aggravate physical problems, proper use of your computer system must be considered as just one element of a healthy lifestyle.

No one, of course, can guarantee that you won't have problems even when you follow the most expert advice on using computer equipment. You should always check with a qualified health specialist if muscle, joint, or eye problems occur.

## Eye fatigue

Eye fatigue can occur whenever the eyes are focused on a nearby object for a long time. This problem occurs because the eye muscles must work harder to view an object that's closer than about 20 feet (6 meters). Improper lighting can hasten the development of eye fatigue. Although eye fatigue is annoying, there's no evidence that it leads to permanent damage.

Whenever you're engaged in an activity that involves close-up work—such as reading a magazine, doing craft work, or using a computer—be sure to have sufficient glare-free lighting and give your eyes frequent rest breaks by looking up and focusing on distant objects. Remember to have your eyes examined regularly.

To prevent discomfort and eye fatigue:

- Arrange your workspace so that the furniture is properly adjusted for you and doesn't contribute to an awkward working posture.
- Take frequent short breaks to give your muscles and eyes a chance to rest.

## Arranging your office

Here are some guidelines for adjusting the furniture in your office to accommodate your physical size and shape.

- An adjustable chair that provides firm, comfortable support is best. Adjust the height of the chair so that your thighs are horizontal and your feet flat on the floor.

The back of the chair should support your lower back (lumbar region).

Follow the manufacturer's instructions for adjusting the backrest to fit your body properly.

- When you use the computer keyboard, your shoulders should be relaxed. Your upper arm and forearm should form an approximate right angle, with your wrist and hand in roughly a straight line.

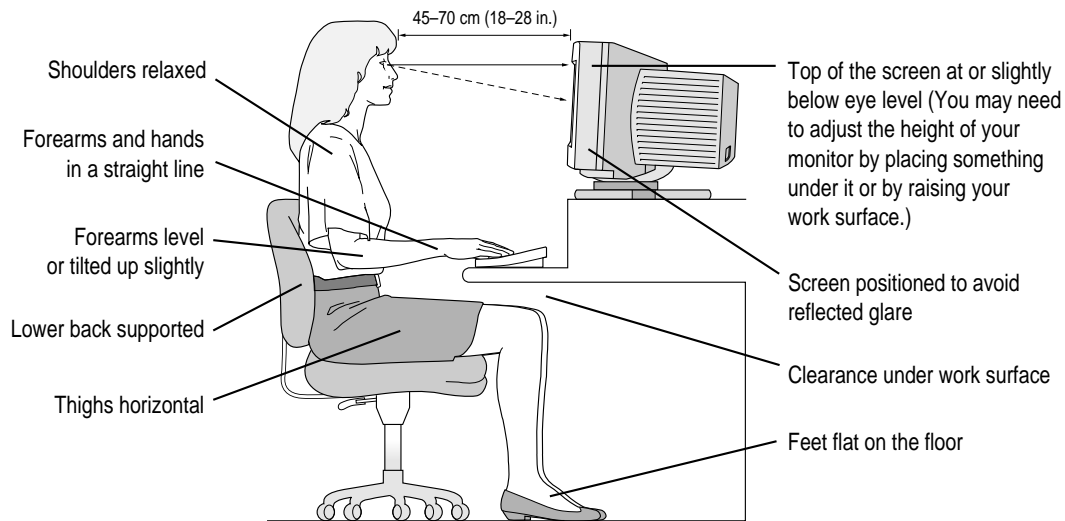

You may have to raise your chair so that your forearms and hands are at the proper angle to the keyboard. If this makes it impossible to rest your feet flat on the floor, you can use a footrest with adjustable height and tilt to make up for any gap between the floor and your feet. Or you may lower the desktop to eliminate the need for a footrest. Another option is to use a desk with a keyboard tray that's lower than the regular work surface.

- Position the mouse at the same height as your keyboard. Allow adequate space to use the mouse comfortably.
- Arrange the monitor so that the top of the screen is slightly below your eye level when you're sitting at the keyboard. The best distance from your eyes to the screen is up to you, although most people seem to prefer 18 to 28 inches (45 to 70 cm).
- Position the monitor to minimize glare and reflections on the screen from overhead lights and windows. You may want to use a tiltable monitor stand. The stand lets you set the monitor at the best angle for viewing, helping to reduce or eliminate glare from lighting sources you can't move.

## Avoiding fatigue

- Change your seated position, stand up, or stretch whenever you start to feel tired. Frequent short breaks are helpful in reducing fatigue.
- Use a light touch when typing or using a mouse and keep your hands and fingers relaxed.
- Some computer users may develop discomfort in their hands, wrists, or arms after intensive work without breaks. If you begin to develop chronic pain or discomfort in your hands, wrists, or arms, consult a qualified health specialist.
- Allow adequate workspace so that you can use your keyboard and mouse comfortably. Place papers or other items so that you can view them easily while using your computer. A document stand may make reading papers more comfortable.
- Eye muscles must work harder to focus on nearby objects. Occasionally focus your eyes on a distant object, and blink often while you work.
- Clean your screen regularly. Keeping the screen clean helps reduce unwanted reflections.

## What about electromagnetic emissions?

There has been recent public discussion of the possible health effects of prolonged exposure to extremely low frequency (ELF) and very low frequency (VLF) electromagnetic fields. Such fields are associated with electromagnetic sources such as television sets, electrical wiring, and some household appliances—as well as computer monitors.

Apple has reviewed scientific reports and sought the counsel of government regulatory agencies and respected health organizations. Based on the prevailing evidence and opinions, Apple believes that the electric and magnetic fields produced by computer monitors do not pose a health risk.

In response to those customers who wish to reduce their exposure to electromagnetic fields, Apple has lowered the emission levels of our products. We are also actively encouraging further scientific research so we can continue to promote the health and safety of our customers and employees.

## Appendix B Getting Help

When you have questions about how your system software works, look to the Guide menu for access to on-screen help. The Guide menu is identified by a question mark (Ⓜ) in the upper-right corner of the screen.

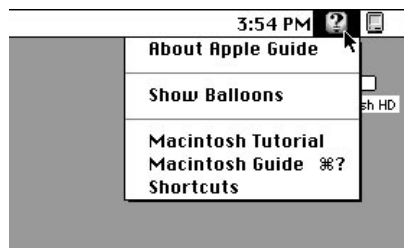

This appendix provides information on the various kinds of on-screen help available in the Guide menu:

- Macintosh Tutorial for learning the basics
- Macintosh Guide for step-by-step assistance in using the Macintosh Operating System (Mac OS)
- Balloon Help for quick definitions of on-screen objects
- Shortcuts for increased desktop productivity

Some application programs also put access to help information in the Guide menu.

---

## Learning the basics

If you are a new Macintosh user, take a look at the Macintosh Tutorial, available in the Guide menu. The tutorial teaches you the basic skills you'll need to use your computer. To start the tutorial, follow these steps:

**1 Slide your mouse along your mouse pad or desk.**

Hold the mouse as shown, with the cable pointing away from you. Don't press the mouse button (under your index finger). Notice that the arrow (↔) on the screen moves in the same direction that you move the mouse.

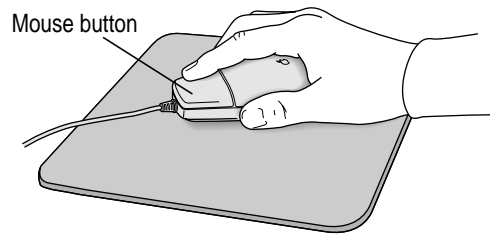

If the arrow doesn't move, make sure that the cables connecting the mouse and keyboard are secure and that your mouse is positioned as shown in the illustration.

**2 Move the tip of the arrow (↔) to the question mark (?) in the upper-right portion of the screen.**

If you run out of room on your mouse pad or desk while moving the mouse, pick up the mouse and place it where there's more room. (The arrow on the screen moves only when the mouse is in contact with the mouse pad or desk.)

**3 With the tip of the arrow on the question mark, press and hold down the mouse button.**

A list of choices (called a menu) appears. This is the Guide (?) menu, which is the place to go when you have a question about how to use your computer.



- 4 While holding down the mouse button, move the arrow until the words “Macintosh Tutorial” are highlighted, then release the mouse button.

A window appears welcoming you to the tutorial. You can set this book aside for now and follow the instructions on the screen. When you have completed the tutorial, return to this book.

## Reviewing the basics

The following illustration summarizes many of the basic skills and terms you learned from the tutorial.

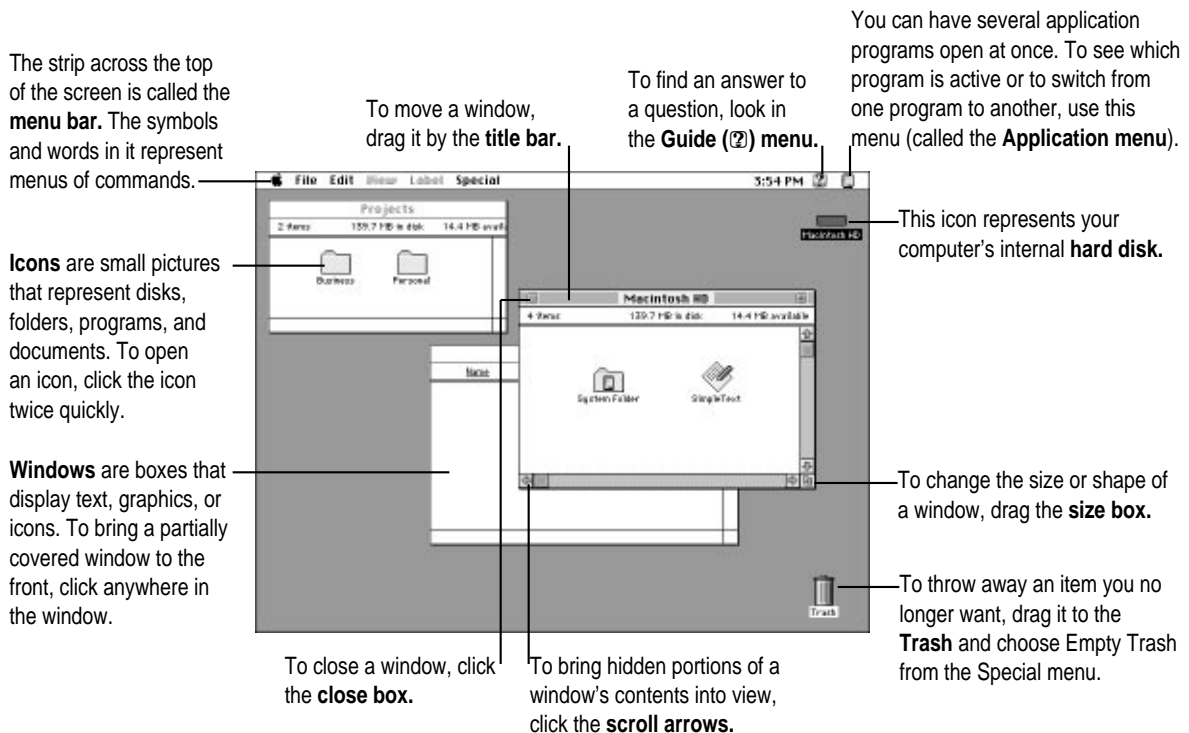

## Getting answers in Macintosh Guide

When you have a question while working with your computer, you can get the answer by choosing Macintosh Guide from the Guide menu.

- 1 Pull down the Application menu (in the upper-right corner of the screen) and choose Finder to make it the active application program.



A checkmark in the menu indicates that the Finder is the active program.

- 2 Pull down the Guide menu (marked with the ? icon) and choose Macintosh Guide.

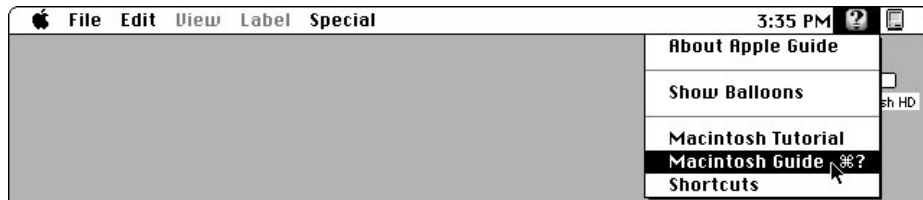

The Macintosh Guide window appears.

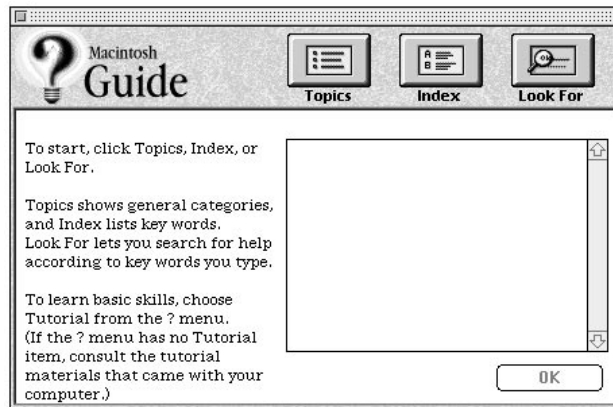

Whenever you use Macintosh Guide, its window remains in front of other windows. If the window gets in your way, you can move it by dragging its title bar (the gray bar across the top of the window).

**3 Notice the three buttons at the top of the window: Topics, Index, and Look For.**

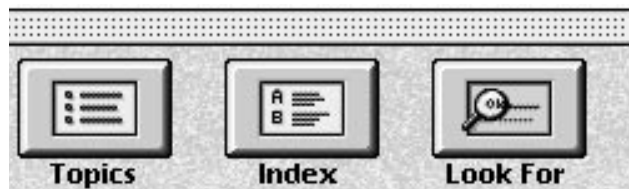

Macintosh Guide gives you three ways of finding information:

- *Topics* lets you choose from a list of general subjects; it is like the table of contents in a book.
- *Index* lets you choose from an alphabetical list of more specific subjects; it is like the index in a book.
- *Look For* lets you search for information related to a specific word or phrase that you type.

In the following sections you will practice using each method.

If you have problems while using Macintosh Guide, see “Tips for Using Macintosh Guide” later in this chapter.

## Getting answers with the Topics button

- 1 In the Macintosh Guide window, click the Topics button.

A list of general topics appears on the left side of the Macintosh Guide window. (Depending on the hardware and software you have, the list of topics may be different.)

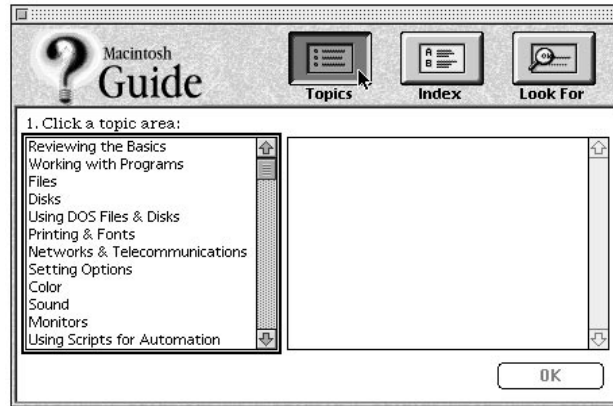

- 2 Click "Setting Options" in the list of topics.

When you click any topic area, a list of related questions appears on the right side of the Macintosh Guide window.

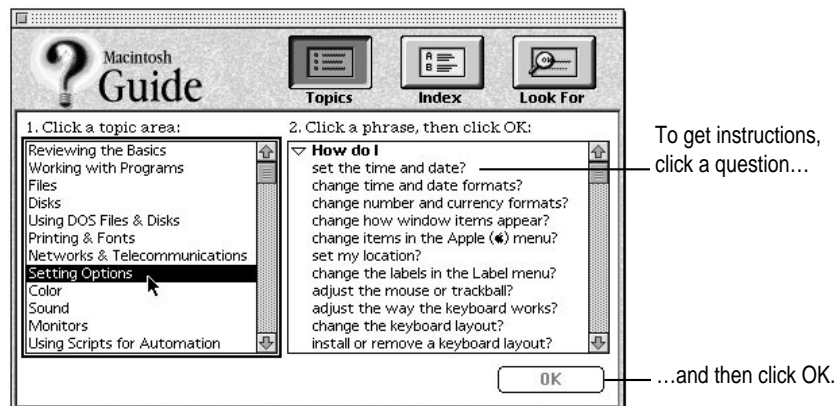

- 3 Click the question “How do I set the time and date?” and then click OK. Or double-click the question.

A small window appears with instructions for you to follow.

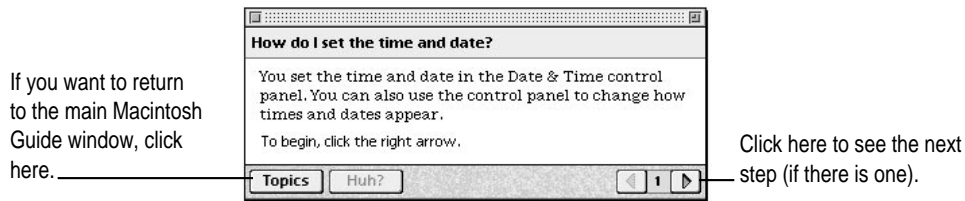

- 4 Read and follow the instructions in this window.

Macintosh Guide provides step-by-step instructions to answer the question you selected. When you have completed each step, click the right arrow in the lower-right corner to see the next step.

- 5 When you have completed all the steps, click the Topics button in the lower-left corner to return to the main Macintosh Guide window.

Now continue with the next section.

## Getting answers with the Index button

- 1 In the Macintosh Guide window, click the Index button.

An alphabetical list of subjects appears on the left side of the window.

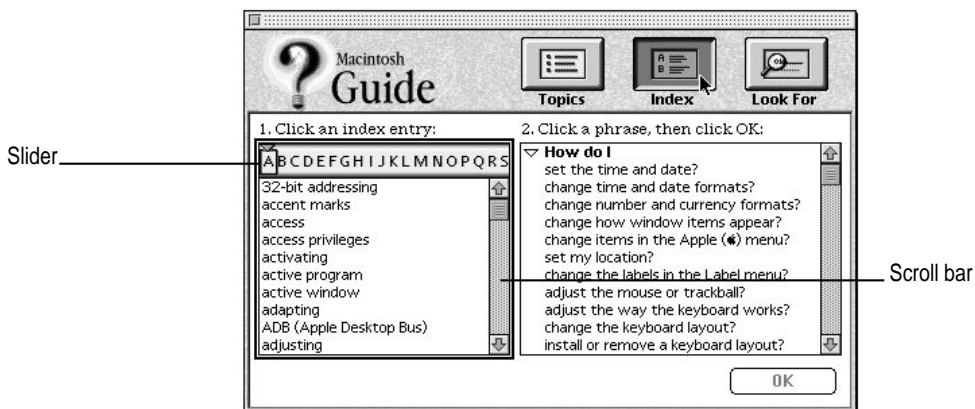

- 2 Scroll through the alphabetical list until the phrase “background pattern” is visible.

You can scroll through the list either by dragging the slider to the letter *B* or by using the scroll bar at the right of the list.

- 3 Click the phrase “background pattern” in the alphabetical list.

When you click any index entry, a list of related questions appears on the right side of the Macintosh Guide window.

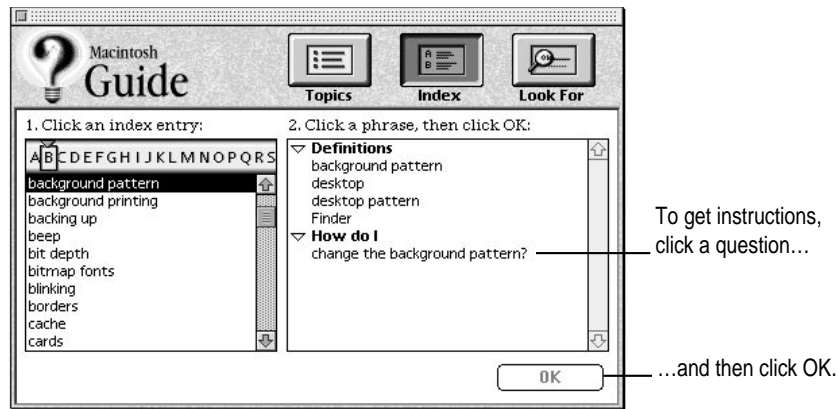

- 4 Click the question “How do I change the background pattern?” and then click OK. Or double-click the question.

A small window appears with instructions for you to follow.

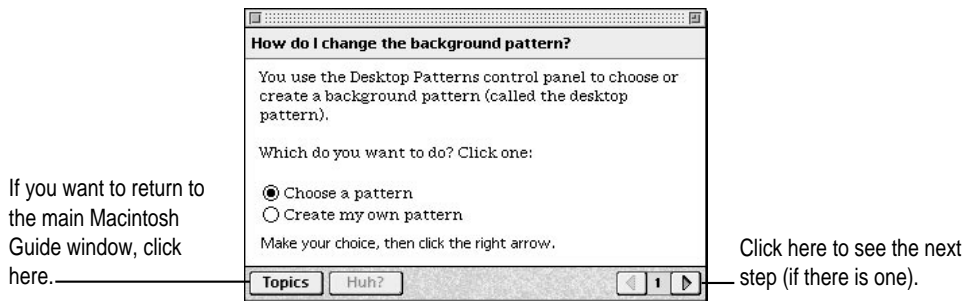

**5 Read and follow the instructions in the window.**

Macintosh Guide provides step-by-step instructions to answer the question you selected. When you have completed each step, click the right arrow in the lower-right corner to see the next step.

**6 When you have completed all the steps, click the Topics button in the lower-left corner to return to the main Macintosh Guide window.**

Now continue with the next section.

### Getting answers with the Look For button

**1 In the Macintosh Guide window, click the Look For button.**

A small box appears on the left side of the window, where you can type text.

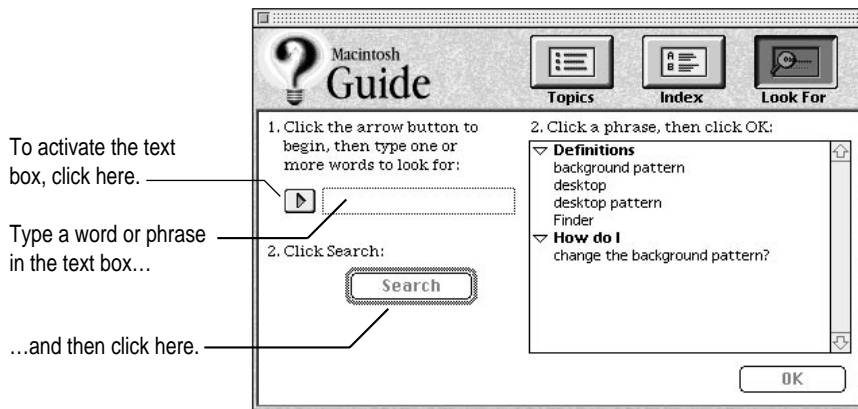

**2 Click the arrow button to activate the text box.**

**3 Type sound in the text box and then click Search.**

When you click Search, a list of questions related to the word or phrase you typed appears on the right side of the Macintosh Guide window.

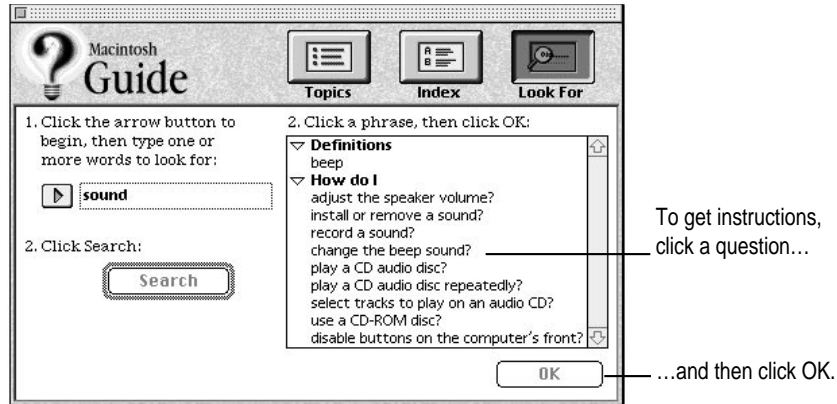

**4 Click the question “How do I change the beep sound?” and then click OK. Or double-click the question.**

A small window appears with instructions for you to follow.

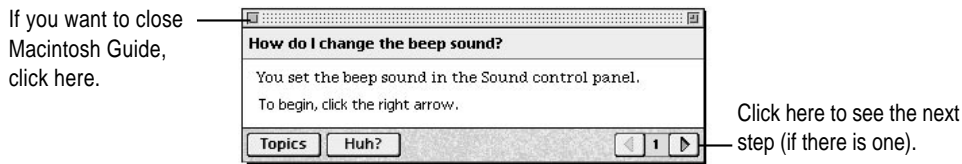

**5 Read and follow the instructions in the window.**

Macintosh Guide provides step-by-step instructions to answer the question you selected. When you have completed each step, click the right arrow in the lower-right corner to display the next step.

**6 When you have completed all the steps, click the close box in the upper-left corner to close Macintosh Guide.**

## Tips for using Macintosh Guide

Here are a few tips for using Macintosh Guide effectively:

- Macintosh Guide is available only when you are in the Finder—the desktop area where you can see the icons of disks, folders, and files. (Other programs may also have help available in the Guide menu, however.) If you don't see Macintosh Guide in the Guide menu, pull down the Application menu (to the right of the Guide menu) and choose Finder.
- Follow the steps when you're instructed to; don't skip ahead or read ahead. That way the computer can check to make sure you've done a step correctly.
- Unlike most windows, the Macintosh Guide window stays in front of other windows on the screen so that your instructions are never covered. If you need to move the Guide window out of the way, drag it by the title bar at the top of the window.

You can also move the window out of the way by clicking the zoom box. Click the box once to shrink the window; click it a second time to expand the window to its original size.

- If you need more information about an instruction or a term, click the button labeled “Huh?” to get further explanation. (The “Huh?” button is dimmed when no additional information is available.)
- If you want to return to the main Macintosh Guide window, click the Topics button in the lower-left corner of the Guide window.
- When you're finished using Macintosh Guide, click the close box in the upper-left corner of the window.

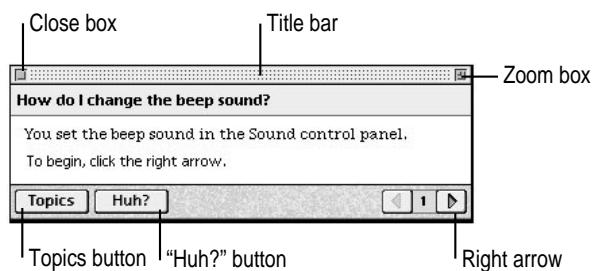

## Identifying objects on the screen

Sometimes you'll see an unfamiliar item on the screen and ask yourself, "What's that?" You can get an answer by using a Macintosh feature known as Balloon Help.

Balloon Help explains the function of icons, menus, commands, and other items on the Macintosh screen in balloons like those you see in comic strips.

Follow these steps to use Balloon Help:

- 1 Pull down the Guide menu (marked with the  icon) and choose Show Balloons.

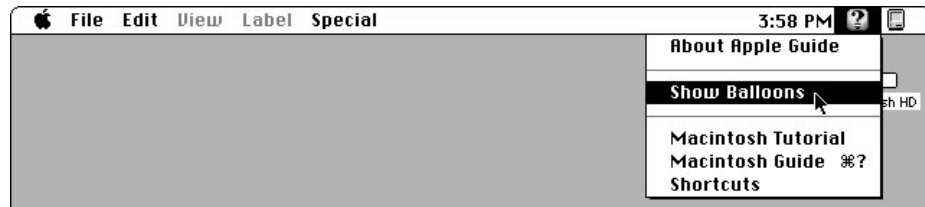

- 2 Point to any object on the screen that you want to identify.

A balloon appears next to the object. In the following illustration, for example, pointing to the Trash displays a balloon that explains how to use the Trash to throw items away.



Although balloons appear next to items when you point to them, the way you work does not change; you can still select icons, choose commands, and so on.

- 3 When you're finished using Balloon Help, choose Hide Balloons from the Guide menu.

## Learning useful shortcuts

You can perform many tasks in the Finder more quickly if you use keyboard or mouse shortcuts. For example, instead of clicking an icon and choosing Open from the File menu, you can simply double-click the icon to open it.

Follow these steps to learn keyboard and mouse shortcuts:

- 1 Pull down the Guide menu (marked with the  icon) and choose Shortcuts.

The main Macintosh Shortcuts window appears.

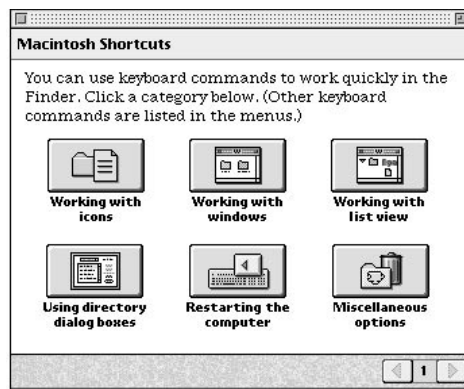

- 2 Click one of the category buttons.

Another window appears, describing shortcuts for that category.

If you want to close the window, click here.

Click here to return to the main Macintosh Shortcuts window for more categories.

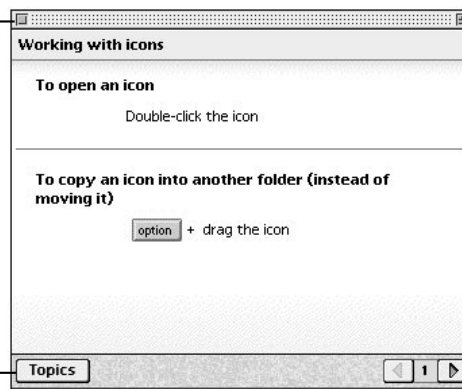

Click here to see the next window (if there is one).

**3 Read about the shortcuts available for the category you selected.**

Click the right arrow in the lower-right corner of the window to display the next window (if there is one).

**4 When you finish reading about the shortcuts for your category, click the Topics button in the lower-left corner to return to the main Macintosh Shortcuts window. Or click the close box in the upper-left corner to close the window.**







## Appendix C Special Keys on Your Keyboard

Your server keyboard contains certain special keys that typewriter keyboards don't have. Many of these keys allow you to give commands to the server without using the mouse. For example, in many application programs, pressing the ⌘ (Command) key at the same time as the Q key is often an alternate method of quitting a program.

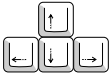
The following table describes what you can do with the special keys on your keyboard. The number of special keys on your keyboard may vary from this list; it depends on the model of keyboard you have.

### Special keys on Apple keyboards

---











<b>Arrow keys</b>		Use to move the insertion point, as an alternative to using the mouse to move the pointer. In some programs, the arrow keys have other functions.
<b>Caps Lock key</b>		Use to capitalize a series of letters. (Numbers and symbols aren't affected.)
<b>Clear key</b>		Use to delete the current selection (or use the Delete key). In some programs, Clear has other functions.
<b>⌘ (Command) key</b>		Use in combination with other keys as an alternative to choosing a menu command.
<b>Control key</b>		In combination with other keys, this key provides shortcuts or modifies other actions.
<b>Delete key</b>		Use to delete selected material, or the character to the left of the insertion point.

Continued on following page ►

---

## Special keys on Apple keyboards *(continued)*

---

<b>Enter key</b>		In a dialog box, pressing Enter is the same as clicking the outlined button. In some programs, pressing this key confirms information you have provided.
<b>Escape key</b>		The function of this key depends on the program you're using.
<b>Function keys</b>		Some programs allow you to use the 12 function keys to give commands. You can assign commands or action sequences to function keys with special utility programs.
<b>Option key</b>		Use in combination with other keys to produce special characters or modify actions.
<b>Numeric keys</b>		Use to produce numbers and ; some programs use these keys as function keys to initiate actions.
<b>Power On key</b>		On some models, press to turn on the server. Also press to shut down the server on certain models.
<b>Return key</b>		Use to move the insertion point to the beginning of the next line. In a dialog box, pressing Return is the same as clicking the outlined button.
<b>Shift key</b>		Use to produce capital letters (or the upper character on the key).
<b>Other special keys</b>		The function of these keys depends on the operating system and program you're using.
<b>Tab key</b>		Use to move the insertion point to the next stopping place (such as a tab stop or field in a dialog box or program).

---

## Appendix D Using Stereo Audio

Your server produces stereo sound and provides several options for high-quality audio.

When an audio device is connected to the sound input port, you can hear or record the incoming sound on the server.

When an audio device is connected to the sound output port, you can record the sound produced by the server or play that sound through external speakers.

This appendix explains how to connect stereo equipment to your Workgroup Server 6150.

---

## About your server's sound ports

Your server can play and record stereo sound from a variety of sources. To provide or reproduce stereo sound, you can connect audio devices to the sound input and output ports on the server. You can also use the server's internal CD-ROM drive to play audio compact discs (CDs).

The sound input port is identified with an icon of a microphone. The sound output port is identified with an icon of a speaker.

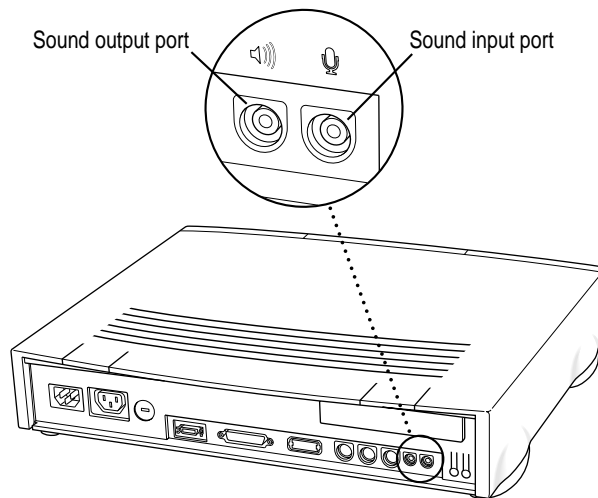

The server's sound ports accept an audio connector known as a stereo miniplug. This connector is the type used on headphones for a personal tape player, for example. If your equipment uses a different type of connector, you can purchase an adapter at an electronics supply store.

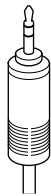

Stereo miniplug

## Connecting an audio device

To play or record sound with your server, you can attach a microphone, amplifier, tape recorder, or a pair of speakers.

Follow these steps to connect an audio device to the server.

- 1 Make sure that the audio device has a cable with a stereo miniplug connector.**  
If not, attach an adapter that has a stereo miniplug.
- 2 Place the audio device near the server.**
- 3 Shut down the server and turn off the audio device.**
- 4 Attach the cable to the audio device and to the sound port on the server.**
- 5 Turn on the server and the audio device and begin working with sound.**

*About microphones:* Be sure to use a microphone designed for your model of the server, such as the Apple PlainTalk Microphone. You can obtain information about other microphones from an Apple-authorized dealer.

The Apple PlainTalk Microphone and the software needed for using spoken commands are available from Apple-authorized dealers.

## Choosing audio input options

You use the Sound control panel to choose the audio input device and options you want.

Follow these steps to choose the sound input device:

- 1 If you want to use an external device for sound input, connect it to the sound input port, following the instructions in the previous section.**
- 2 Open the Sound control panel and choose Sound In from the pop-up menu.**

The Sound control panel is in the Control Panels folder in the Apple () menu.

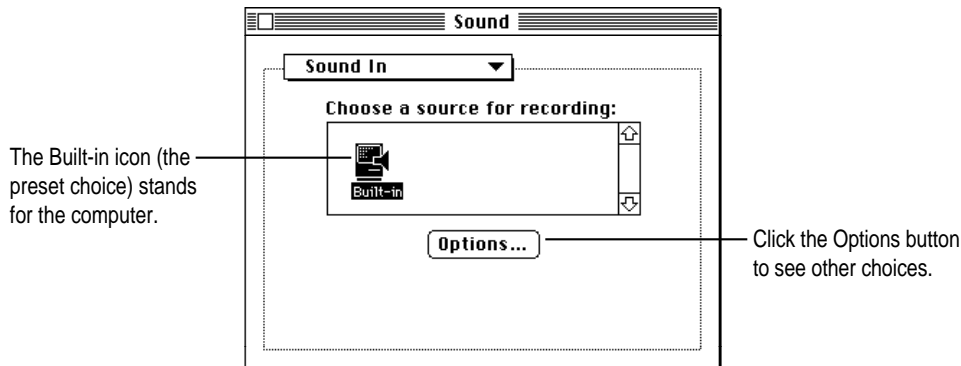

**3 To change the selected sound input device, click the Options button.**

The Input Source options appear.

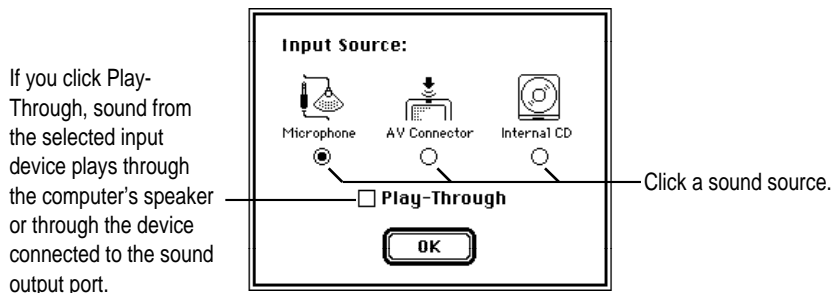

If you click Play-Through, sound from the selected input device plays through the computer's speaker or through the device connected to the sound output port.

The Microphone icon stands for the device connected to the sound input port. The AV Connector icon stands for the AudioVision monitor's built-in microphone.

**4 Click the button for the audio device you want to hear; then click OK.**

*If you have software for using spoken commands with your computer, please note:*

- To use an AudioVision monitor's microphone for spoken commands, select the AV Connector icon in the Input Source options.
- To use a microphone connected to the sound input port for spoken commands, select the Microphone icon.
- If Play-Through is selected, you won't be able to give spoken commands to the computer.

## Choosing audio output options

You use the Sound control panel to designate the audio output device and options you want.

Follow these steps to direct the server's sound to an output device:

- 1 If you want to use an external device for sound output, connect it to the sound output port, following the instructions given earlier in "Connecting an Audio Device."
- 2 Open the Sound control panel and choose Sound Out in the pop-up menu.

The Sound control panel is in the Control Panels folder in the Apple () menu.

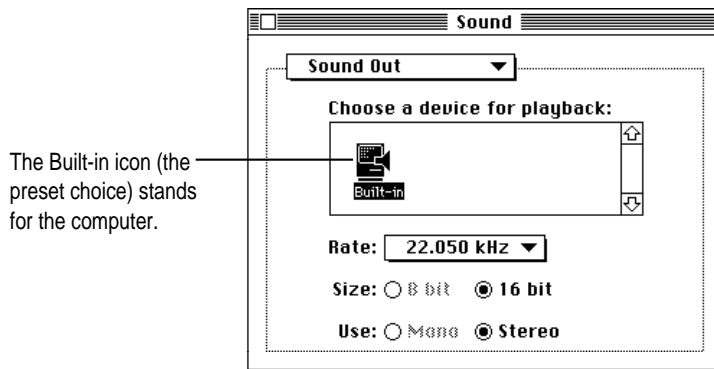

- 3 Click the icon that represents the source of sound output.

*About the sample rate:* Most of the time you will not need to change the sample rate. Use the Rate pop-up menu to change the sample rate only if the sound you wish to play was recorded at a sample rate different from the current setting. For instance, if you play a QuickTime movie containing sound recorded at 44.1 kHz, set the sample rate in the Rate pop-up menu to 44.1 to hear the full quality of the sound. Increasing the sample rate slows performance.

- Do not set the sample rate higher than the sample rate of the sound you are playing, since this slows your server's performance without improving sound quality.
- Do not change the sample rate if the Play-Through option is selected.

- Do not change the sample rate for sound coming from a device connected to the sound input port.

The other options cannot be changed. If you use a program that provides sound recording in mono format, you can use its mono setting.

**4 Close the Sound control panel.**

## Recording an alert sound

Although your server can produce stereo sound, the server records alert sounds in the same way as other Macintosh models: in 8-bit mono sound, at a sample rate of 22.254 kHz. This makes the alert sounds you record compatible with all Macintosh computers. For instructions on recording an alert sound, see the “Sound” topic in Macintosh Guide, available in the Guide menu.

## Connecting external stereo speakers

You can take advantage of your server’s stereo sound output by connecting external powered (amplified) speakers.

**1 Assemble the speakers and the cable you need.**

You need a cable with stereo miniplugs at each end to connect one or both speakers to the computer. (Some speakers require a dual-plug adapter. Others, like those shown here, accept a single stereo miniplug and are joined by standard speaker wires.)

The following illustration shows the equipment configuration and the connections for a computer sound system.

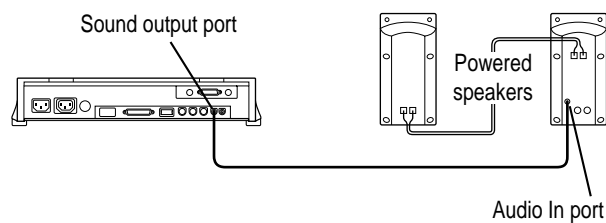

- 2 Turn off the server.
- 3 Plug a stereo miniplug into the sound output port on the server.
- 4 Plug a stereo miniplug into the Audio In socket on one of the speakers.  
If the speakers take a dual-plug cable, connect both plugs.
- 5 Connect the speakers together with speaker wires, if necessary.
- 6 Turn on the server.

Now you hear the computer's sound through the external speakers.

*Note:* To control the volume of your external speakers, open the Sound control panel and choose Volumes in the pop-up menu. Use the Built-in Headphones slider to adjust your external speakers. If you are playing an audio CD, you may also need to adjust the volume control in the program you're using to play CDs.

## Playing audio CDs

You can play audio CDs by using your server's internal CD-ROM drive or an external CD-ROM drive or CD player that you've connected to your server.

Follow these steps to play CD audio sound through the server's internal speaker:

- 1 Place an audio CD in the CD-ROM drive or CD player.  
See the information that came with your server or external equipment for details about inserting a CD.
- 2 Use the Sound control panel to choose the CD-ROM drive or CD player as the sound input device and click Play-Through to hear the CD.
- 3 Use your audio CD software to play the CD.

If you have either the CD Remote program or the AppleCD Audio Player program, choose the program from the Apple () menu and click Play.

See the instructions that came with your CD-ROM drive for more information about playing audio CDs.



# Index

## A

- access port cover, removing 28
- accessory kit xiv
- activating applications 90
- adapters
  - Apple Ethernet AUI 16, 19–20
  - for expansion card (PDS or NuBus) 26, 29–31
  - GeoPort Telecom 42
  - LocalTalk 20–21
  - media 15, 16
    - connecting 16
    - monitor cable 7
- ADB port 3, 5, 8, 41
- air circulation 77
- alert sound
  - recording 108
- aliases
  - creating and placing in Startup Items folder 46
  - renaming for program startup order 47
- amplifier, connecting 105
- Apple AudioVision monitor 5–6, 8, 10, 42, 106
- Apple Ethernet AUI Adapter 16, 19–20
- Apple Ethernet Thin Coax Transceiver 16
- Apple Ethernet Twisted-Pair Transceiver 16
- Apple HD SC Setup program 39, 67, 71
- Apple LocalTalk Locking Connector Kit DIN-8 20
- Apple PlainTalk Microphone 41, 105

- Apple Remote Access xv, 45
- AppleCD Audio Player program 109
- AppleScript 48
- AppleSearch xv, 46
- AppleShare xv, 46
- AppleShare Print Server 47
- AppleTalk 22–23. *See also* EtherTalk
- Application menu 90, 97
- application programs. *See* programs
- arrow keys 101
- audio. *See* sound
- audio CDs, playing 104, 109
- audio devices, connecting to the server 105–108
- audio input options, choosing 105–106
- audio output options, choosing 107–108
- AudioVision monitor 106
- AUI adapter 16, 19–20
- AV Connector Input Source option 106

## B

- backup programs 54, 60, 69
- Balloon Help 87, 98
- bar-code reader, connecting 41
- blinking question mark 11, 51, 60
- “bomb” icons or messages 50, 56
- brightness control 12, 51
- built-in AppleTalk for Ethernet network (EtherTalk) 22
- built-in SCSI terminators 38

---

## C

### cables

- connecting and disconnecting 77
  - Ethernet 16, 17, 18, 19
  - external speaker 108
  - fiber-optic 19
  - keyboard 8
  - LocalTalk 20–21
  - monitor 7
  - mouse 8
  - SCSI 37
  - thin coaxial (Ethernet) 17
  - twisted-pair (Ethernet) 18
- capital letters 101, 102
- Caps Lock key 101
- carpal tunnel syndrome 83
- case, cleaning 80
- CD Remote program 109
- CD-ROM disc, *Workgroup Server Software* 39, 52, 54–56, 60, 61, 62, 64, 69
- CD-ROM drive xv, 2, 25, 104, 109
- starting the server from 61
- CD-ROM software, reinstalling 69
- CDs, playing 104, 109
- chair, adjusting for computer use 84–85
- characters, special 102
- Chooser 40
- cleaning
- case 80
  - keyboard 78
  - monitor 81
  - mouse 81–82
  - spills 77, 78
- clean installation of system software 66–68
- Clear key 101
- coaxial cable 16, 17
- Command (⌘) key 101

### commands

- assigning to function keys 102
  - shortcuts for 99, 102
- communications and fax software 42
- communications card 15
- components
- internal 25
  - of your server 2
- connecting equipment to the server
- amplifier 105
  - audio devices 105
  - bar-code reader 41
  - external speakers 105, 108–109
  - GeoPort Telecom Adapter 42
  - graphics tablet 41
  - microphone 41, 105
  - modem 42
  - monitor cable 7
  - monitors 5–8, 40
  - mouse and keyboard 8
  - other devices 9
  - printer 40, 42
  - SCSI devices 34–39
  - tape recorder 105
  - trackball or other input device 41
- connectors
- adapter card 31
  - expansion slot 26, 29, 31
  - handling 77
  - stereo miniplug 104, 105, 108–109
- contrast control 12
- Control key 101
- control panels
- Memory 44–45, 57
  - Monitors 51
  - Network 22–23
  - PC Exchange 58, 59
  - removing 66
  - Sound 105–106, 107–108, 109

- Control Panels item (in Apple menu) 22
- copying
  - disk images 64
  - system software from the *Workgroup Server Software* CD-ROM disc to floppy disks 64–65
- cover of server
  - removing 27
  - replacing 33
- cumulative trauma disorders (CTDs) 83
- custom utilities, removing 66
- customer support hotline xvi

## D

- date, setting system 12
- Date & Time control panel 12
- Delete key 101
- deleting selected material 101
- desk accessories 57
- desktop (Macintosh), rebuilding 54, 59
- device drivers, installing 38–39
- disconnecting power to the server 10, 27
- Disk Copy program 64
- Disk Duplicator dialog box 64
- Disk First Aid 67, 72–73
- disk images, copying 64
- Disk Images folder 64
- disk repair programs 72–73
- Disk Tools* floppy disk 61
- documentation, on-screen xiv
- documents
  - DOS 58
  - problems opening 58–59
- DOS disks, formatting 55
- DOS documents, problems with 58–59
- DRAM SIMM slots 25
- dynamic RAM (DRAM) 25

## E

- ejecting disks 52, 79
  - problems with 79
- electromagnetic emissions 86
- Enter key 102
- erasing
  - floppy disks 73
  - selected material 101
- error messages, general suggestions for resolving 49–50
- errors, hard disk drive 39
- Escape key 102
- Ethernet 15, 16–20, 22
  - AUI adapter 16, 19–20
  - icon 16
  - port 3, 16, 17
  - thin coaxial cable 17
  - thin coaxial transceiver 17
  - transceivers 19
  - twisted-pair transceiver 18
- EtherTalk 22
- expanding Macintosh Guide window 97
- expansion card
  - adapter 26, 29–31
  - installing 5, 26–33
- expansion slot 25–26, 31
  - connector 26, 29
- Extensions folder 57
- extensions, removing 66
- external devices
  - for sound input 105–106
  - for sound output 107
  - hard disk, problems with 51
  - speakers 105, 108
  - terminators for SCSI devices 38
  - turning on 10
- external hard disk, problems with 54
- eye fatigue related to computer use 82, 83, 84

## F

- factory-installed card, removing 26
- fatigue from computer use, avoiding 86
- fax software 42
- FDDI network 15
- fiber-optic media 16
- File menu, Make Alias item in 46
- Finder
  - activating 90, 97
  - Macintosh Guide and 90, 97
  - shortcuts in 99
- floppy disk drive 2
  - ejecting disk from 52, 79
- floppy disks
  - copying system software onto 64–65
  - ejecting 52, 79
  - erasing 73
  - handling 79
  - icon with “X” appears 52
  - inserting and ejecting 52
  - problems with 54
  - repairing 72–73
  - starting the server from 61
  - troubleshooting 79
  - unreadable 54
- folders
  - Disk Images 64
  - Extensions 57
  - Startup Items 46
  - System Folder 39, 44, 46, 49, 59, 60, 66, 68
- footrests 85
- formatting a disk in DOS format 55
- function keys 102

## G

- GeoPort 3, 42
- GeoPort Telecom Adapter, connecting 42
- graphics tablet, connecting 41

## Guide menu

- described xiv, xvi, 87
- Hide Balloons command 98
- Shortcuts command 99
- Show Balloons command 98

## H

- handling computer equipment 77–79
  - floppy disk 79
  - keyboard 78
  - monitor 78
  - power supply 80
- hard disk
  - erasing 73
  - initializing 39, 72
  - repairing 70, 72–73
  - testing 71–72
  - troubleshooting 70–73
  - using hard disk space as memory 43
- hard disk drives
  - errors 39
  - internal 2, 25
  - problems with 39, 52, 53–54
- HD SC Setup. *See* Apple HD SC Setup program
- health-related information about computer
  - use 82–86
- health tips
  - electromagnetic emission 86
- help, on-screen xiv, 87
- Hide Balloons command (Guide menu) 98
- high-density monitor port 3
- Huh? button (Macintosh Guide window) 97

## I, J

- icons
  - ADB 8, 41
  - Apple HD SC Setup 71
  - blinking question mark 11, 51, 60

- disk with “X” 52
- GeoPort 42
- Guide menu 87
- hard disk drive 11
- modem port 42
- network connection 23
- printer port 40
- “sad Macintosh” 53
- SCSI 34
  - troubleshooting 54
- Index button (in Macintosh Guide window) 91, 93
- initializing hard disk 39, 72
- Input Source options 106
- inserting floppy disks 52
- insertion point
  - moving with Return key 102
  - moving with Tab key 102
- Installer program 62–69
- installing
  - applications 48
  - device drivers 38
  - expansion card 5, 26–33
  - internal devices 34
  - memory (RAM) 34
  - programs 47
  - SCSI devices 37–38
  - server application programs 46
  - setting up the server 1–13
  - system software 57, 60–63, 66–68
- Install Me First* floppy disk, starting the server
  - from 62
- interference 78
- Internal CD Input Source option 106
- internal components 2, 25, 26–33
- interrupt switch 3
- isolating the server for security 4

## K

- keyboard
  - cable 8
  - connecting 8
  - handling 78
  - problems with 56
  - proper positioning of 85
  - spills on 78
- keyboard shortcuts 99
- keys, special 102

## L

- LaserWriter Pro printer 40
- light-emitting diodes (LEDs) 18
- LocalTalk
  - adapter 20–21
  - cable 21
  - Locking Connector Kit DIN-8 20
  - network 15, 20–21, 22
  - selecting 22
- locking cable, attaching 4
- Look For button (Macintosh Guide window) 91, 95

## M

- Macintosh Guide
  - described xiv, xvi, 87
  - using 90–93
- Macintosh Guide window
  - closing 97
  - Huh? button 97
  - Index button 91, 93
  - Look For button 91, 95
  - moving 97
  - moving to next step in 93
  - returning to 93, 97
  - searching for general subjects in 91, 92–93
  - searching for specific subjects in 91, 93–95
  - searching for words or phrases in 91, 95–96

- Macintosh Guide window (*continued*)
    - shrinking and expanding 97
    - tips for using 97
    - Topics button 91, 92
  - Macintosh Tutorial 87, 88, 89
  - Make Alias item (in File menu) 46
  - mathematical symbols 102
  - media adapter 2, 15–20
  - memory
    - expanding 34
    - not enough 43, 44, 57
    - virtual 43
  - Memory control panel 44–45, 57
    - Memory Manager setting in 44
  - microphone 106
    - Apple PlainTalk 41, 105
    - built into AudioVision monitors 5
    - connecting 41, 105
    - Input Source options for 106
  - microprocessor, PowerPC xi
  - modem port 3
    - connecting a printer to 40
  - modems, connecting 42
  - Modern Memory Manager setting (in Memory control panel) 45, 57
  - moisture, avoiding 78
  - monitor cable 7
    - adapter 7
    - connecting 7–8
  - monitor ports 3, 5, 7
  - monitor power socket 3
  - monitors
    - adjusting brightness and contrast 12, 51, 78
    - AudioVision 5, 6, 8, 10, 42, 106
    - brightness control on 12, 51, 78
    - cleaning 81
    - connecting 5–8, 40
    - handling 78
    - image “burn in” on screen 78
    - interference on screen 78
    - power switch 10
    - problems with 51
    - proper positioning of 5, 85
    - standard 5, 7
    - troubleshooting 78
    - turning on 10
  - Monitors control panel 51
  - mouse
    - cable 8
    - cleaning 81–82
    - connecting 8
    - positioning for comfortable use 85
    - problems with 55
  - mouse shortcuts 99
  - moving
    - insertion point with keys 102
    - Macintosh Guide window 97
  - muscle soreness related to computer use 82
  - musculoskeletal discomfort related to computer use 83
- N**
- network connection
    - Apple Ethernet 16–20
    - Apple LocalTalk 20
    - switching 22–23
  - Network control panel 22
  - networks
    - Ethernet 15, 16–20
    - FDDI 15
    - LocalTalk 15, 20–21
    - Token Ring 15
  - network services xv, 23, 45–47
    - Apple Remote Access xv, 45
    - AppleSearch xv, 45
    - AppleShare xv, 45
  - non-Apple operating system 39
  - non-Apple products 39
  - NuBus
    - adapter 26, 29–31
    - expansion card 26
  - numeric keys 102

## O

- office furniture, optimal arrangement of 84
- on-screen documentation xiv
- on-screen help xiv–xv, 87–100
- Option key 102
- other special keys 102

## P

- patch cords, twisted-pair 18
- PC Exchange program
  - control panel 58, 59
  - troubleshooting 58, 59
- performance
  - sample rate for sound output and 107
  - server 65–68
- PlainTalk Microphone 105
- Play-Through sound option 106, 109
- plugging in the server 9–10
- pointer, problems with 55
- ports
  - ADB 3, 5, 8, 41, 56
  - Ethernet 3, 16, 17
  - GeoPort 3, 42
  - high-density monitor 3
  - modem 3, 40
  - monitor 3, 5, 7
  - printer 3, 20–21, 40
  - SCSI 3, 34
  - security lock 3, 4
  - sound input 3, 41–42, 104
    - connecting external devices 105
    - stereo miniplug and 104
  - sound output 3, 104
    - connecting external devices 107
    - connecting speakers 108–109
    - stereo miniplug and 104
  - video 5
- positioning the monitor 5, 85
- power cord
  - monitor 5–6
  - server 9–10

- power light 2
- Power Macintosh
  - computers xi
  - programs xi, 43–44, 57
- power outages 46
- power plug 3
- power supply case, discharging static electricity 28
- power supply, handling 80
- power switch 2, 10, 12, 13
  - on monitor 12
- PowerPC microprocessor xi
- PowerTalk 47
- printer port 3, 20–21, 40
- printers 40
  - connecting 40, 42
  - direct cable connection 40
  - LaserWriter Pro 40
  - LaserWriter Select 40
  - network cable connection 40
  - problems with 51, 59
  - StyleWriter II 40
- processor-direct slot (PDS)
  - adapter 26, 29–31
  - expansion card 26–33
- programs
  - activating 90
  - AppleCD Audio Player 109
  - Apple HD SC Setup 39, 67
  - Apple Remote Access 45
  - AppleSearch xv, 45
  - AppleShare xv, 45
  - backup 54, 60
  - can't be opened 44, 57–59
  - CD Remote 109
  - Chooser 40
  - communications 42
  - Disk Copy 64
  - Disk First Aid 67
  - disk repair 72, 73
  - fax 42
  - incompatible 55

programs (*continued*)  
  Installer 62–69  
  installing 47  
  order of installing and starting 46  
  PC Exchange 58, 59  
  Power Macintosh xi, 43, 57  
  problems opening 44, 57  
  restarting server programs 46  
  screen-saver 51, 78  
  server application xv, 45–46, 66  
  shared libraries and 44  
  supplied with the Workgroup Server 45  
  using older Macintosh programs 44, 57

## Q

QuickDraw GX 47  
QuickTime software, reinstalling 69

## R

random-access memory (RAM) 34  
  not enough 43  
Rate pop-up menu for sound output 107  
Read Me file xiv, 46  
rebuilding the Macintosh desktop 54, 59  
recording an alert sound 108  
Reduced Instruction Set Computer (RISC)  
  technology xi  
reinstalling  
  CD-ROM software 69  
  QuickTime software 69  
  server application programs 66  
  system software 60–63, 66–68  
removing  
  access port cover 28  
  cover of server 27  
  factory-installed cards 26  
repairing  
  floppy disk 72–73  
  hard disk 70, 72–73

repetitive stress injuries (RSIs) 83  
reset switch 3, 50–51  
Restart item (in Special menu) 50  
restarting  
  server application programs 46  
  the server 50, 53  
Return key 102  
RISC (Reduced Instruction Set Computer)  
  technology xi  
RJ-45 telephone-style connector jack 18

## S

safety precautions 13, 75  
sample rate  
  for recording alert sounds 108  
  for sound output 107  
saving  
  before restarting the server 50  
screen  
  identifying objects on 98  
  image “burn in” 78  
  interference on 78  
  problems with 51  
screen brightness control 78  
screen-saver programs 51, 78  
SCSI cables 37  
SCSI chain 70  
SCSI devices  
  connecting 34–39  
  preinstalled 35  
  problems with 35, 52, 53, 54  
  setting up 35–38  
  troubleshooting 70  
SCSI ID numbers 70  
  preset for internal devices 36  
  setting 35–36, 37  
SCSI port 3, 34–35  
SCSI terminators 38  
security issues 3

- security lock port 3, 4
- security lock, attaching 4
- self-terminating transceiver 17
- server application programs
  - information about those included with Workgroup Server xv
  - installing and starting 45–47
  - reinstalling 66
- setting SCSI ID numbers 35–36, 37
- setting system date and time 12
- setting up SCSI devices 34–39
- setting up the server 1–13
- shared libraries 44, 57
- Shift key 102
- shortcuts
  - keyboard 99
  - mouse 99
- Shortcuts item (in Guide menu) 99
- Show Balloons item (in Guide menu) 98
- shrinking Macintosh Guide window 97
- Shut Down item (in Special menu) 13
- Single Inline Memory Modules (SIMMs) 34
  - slot 25
- sound
  - control panel for 105–106, 107–108, 109
  - input port 3, 104
    - connecting external devices 105
    - stereo miniplug and 104
  - Input Source options for 106
  - output
    - sample rate for 107
    - source 107
  - output port 3, 104
    - connecting external devices 107
    - connecting speakers 108–109
    - stereo miniplug and 104
  - recording an alert 108
  - sample rate 107–108
- Sound control panel 105–106, 107–108, 109
- speakers
  - external 105, 108
  - in AudioVision monitors 5
- special characters 102
- Special menu
  - Restart item in 50
  - Shut Down item in 13
- spills 77, 78
- spoken commands 105, 106
- standard monitors 5, 7
- “standby” state when computer is off 10
- starting the server
  - from the *Install Me First* floppy disk 62
  - from the *Workgroup Server Software* CD-ROM disc 52, 55, 56, 60
  - problems with 12, 51, 53
  - using the CD-ROM drive 61
  - using the floppy disk drive 61
- startup disk 57, 60–61
- Startup Items folder 46
- startup screen 11
- static electricity, discharging 28
- stereo miniplug 104–105, 108–109
- stereo sound 103–109
- StyleWriter II printer 40
- System Folder 39, 44, 46, 49, 59, 66, 68
- system software
  - clean installation of 66–68
  - copying to floppy disks 64
  - problems with 11, 52, 57, 60–65
  - reinstalling 60–63, 66–68
  - reinstalling CD-ROM software 69

**T**

- Tab key 102
- tape recorder, connecting 105
- Technical Information* booklet xv, 5, 34, 41
- telecommunications 42
- 10BASE-T hub 18

- terminators
    - Ethernet thin coaxial 17
    - SCSI 38
  - testing the hard disk 71–72
  - thin coaxial (Ethernet) cable 17
  - thin coaxial (Ethernet) network 16, 17
  - thin coaxial (Ethernet) transceiver 17
  - time, setting system date and 12
  - Token Ring network 15
  - Topics button
    - in Macintosh Guide window 91, 92
    - in Macintosh Shortcuts window 100
  - trackball, connecting 41
  - transceivers 15
    - Apple Ethernet AUI Adapter 16
    - Apple Ethernet Thin Coax 16
    - Apple Ethernet Twisted-Pair 16
    - Ethernet 16–20
    - self-terminating 17
    - thin coaxial (Ethernet) 17
    - twisted-pair (Ethernet) 18
  - troubleshooting
    - application program can't be found 58
    - “bomb” icons or messages 50, 56
    - can't eject floppy disk 79
    - can't open documents 58–59
    - clock 53
    - clues on your screen 49
    - DOS disks or documents 55, 58
    - external device problems 51
    - file can't be found 57, 58–59
    - floppy disk is unreadable 54
    - general suggestions 49
    - hard disk drive problems 39, 52–54, 70–73
    - icons don't appear correctly 54
    - incompatible programs 44, 55
    - keyboard problems 56
    - memory problems 43–44, 57
    - mouse problems 55
    - network connection error message at startup 11, 53
    - peripheral device problems 51
    - pointer freezes 55
    - poor server performance 45, 65–68
    - power outages 46
    - print server not functioning properly 59
    - program could not be opened 44, 57–59
    - program quits unexpectedly 57
    - rebuilding the Macintosh desktop 54, 59
    - “sad Macintosh” icon appears 53
    - screen is dark 51
    - SCSI device problems 52, 53, 54, 70
    - shared library missing or not found 44, 57
    - system software problems 11, 52, 57, 60–65
    - turning on the server 12, 51
    - typing doesn't work 56
    - using older Macintosh programs 57
    - where to find answers xvi
    - turning off the server 13, 102
    - turning on external devices 10
    - turning on the server 10–12, 38, 102
    - 12-hour clock 12
    - 24-hour clock 12
    - twisted-pair cable 18
    - twisted-pair patch cord 18
    - twisted-pair transceiver 18
    - typing 101. *See also* keyboard
      - capital letters 101, 102
      - mathematical characters 102
      - special characters 102
      - uppercase letters 101, 102
- U**
- uppercase letters 101, 102
- V**
- ventilation 77-78
  - video port 5
  - virtual memory 43
  - volume control of external speakers 109

## W, X, Y, Z

Workgroup Server Electronic Library xiv–xv

Workgroup Server Read Me file xiv, 46

*Workgroup Server Software* CD-ROM disc 61, 62

    creating startup floppy disks with 64

    reinstalling CD-ROM software from 69

    reinstalling system software from 62–63

    starting the server from 53, 55–56, 60

wrist problems related to computer use 82, 83, 85

## **The Apple Publishing System**

*Administrator's Guide for the Workgroup Server 6150/66* was written, edited, and composed on a desktop publishing system using Apple Macintosh computers, an AppleTalk network system, and QuarkXPress. Line art was created with Adobe™ Illustrator. Proof pages were printed on Apple LaserWriter printers. Final pages were proofed on Creo Plate Master and output by Creo 3244 Platesetter on Hoeschst N90 plates. PostScript™, the LaserWriter page-description language, was developed by Adobe Systems Incorporated.

Text type is Times®, display type is Helvetica® Narrow, and cover type is AppleGaramond, Apple's corporate font. Ornaments are custom symbols designed for Apple Computer. Some elements, such as computer voice, are set in Apple Courier, a fixed-width font.