



Apple

AppleVision 1710AV Display

User's Guide



 Apple Computer, Inc.

© 1995 Apple Computer, Inc. All rights reserved.

Under the copyright laws, this manual may not be copied, in whole or in part, without the written consent of Apple. Your rights to the software are governed by the accompanying software license agreement.

The Apple logo is a trademark of Apple Computer, Inc., registered in the U.S. and other countries. Use of the “keyboard” Apple logo (Option-Shift-K) for commercial purposes without the prior written consent of Apple may constitute trademark infringement and unfair competition in violation of federal and state laws.

Every effort has been made to ensure that the information in this manual is accurate. Apple is not responsible for printing or clerical errors.

Apple Computer, Inc.
1 Infinite Loop
Cupertino, CA 95014-2084
(408) 996-1010

Apple, the Apple logo, AppleTalk, ColorSync, Macintosh, Macintosh Centris, and Macintosh Quadra are trademarks of Apple Computer, Inc., registered in the U.S. and other countries.

Apple Desktop Bus, AppleVision, AudioVision, and PlainTalk are trademarks of Apple Computer, Inc.

Adobe, Adobe Illustrator, Adobe Photoshop, and PostScript are trademarks of Adobe Systems Incorporated, which may be registered in certain jurisdictions.

The Energy Star logo is a service mark of the U.S. Environmental Protection Agency.

ExposurePro is a registered trademark of Baseline Publishing, Inc.

Helvetica and Times are registered trademarks of Linotype-Hell AG and/or its subsidiaries.

QMS is a registered trademark of QMS, Inc.

QuarkXPress is a registered trademark of Quark, Inc.

SuperPaint is a trademark of Aldus Corporation, a subsidiary of Adobe Systems Incorporated, which may be registered in certain jurisdictions.

Tektronix is a registered trademark of Tektronix, Inc.

Trinitron is a trademark of Sony Corporation, registered in the U.S. and other countries.

Simultaneously published in the United States and Canada.

Mention of third-party products is for informational purposes only and constitutes neither an endorsement nor a recommendation. Apple assumes no responsibility with regard to the performance or use of these products.



Contents

Communications regulation information xi

Preface How Much of This Book Do I Have to Read? xiii

Before you begin xiii

For more information xiii

Part I Using the Display With Your Macintosh Computer

1 Setting Up for Macintosh Users 1

Important safety and cleaning instructions 1

What about electromagnetic emissions? 3

Getting ready to set up 4

Your AppleVision 1710AV Display at a glance 5

Choosing a good location for your display 6

Positioning the display 6

Do you need a video card? 7

Using more than one display 7

Connecting the display to your Macintosh computer	8
Connecting the power cord	8
Connecting the display cable	9
Connecting the sound cable	11
Connecting your keyboard and mouse to the display	11
Connecting external sound equipment	12
Connecting sound input equipment to your display	13
Connecting sound output equipment to your display	13
Turning the display on	14
Installing the Macintosh software	15
2 Changing Resolutions and Saving Energy	17
Changing screen resolution	18
Other things you can do with the Monitors control panel	20
Using the Control Strip	20
Conserving energy	20
What happens after you turn on the energy-saving feature	22
Using Energy Saver with a screen saver	22
3 Adjusting the Screen Image	23
Screen controls at a glance	23
Using the AppleVision Setup control panel	24
Opening and closing the AppleVision Setup control panel	24
Automatically opening the AppleVision Setup control panel	26
Using more than one display	27

Adjusting the screen image	27
Adjusting contrast and brightness	27
Adjusting height and width	29
Centering the screen image	31
Adjusting the shape of the screen image	32
Rotating the screen image	34
Adjusting convergence	35
Turning overscan on and off	37
Resetting screen image to original levels	39
4 Fine-Tuning Display Color	41
About color	41
Opening the Color window	42
Setting a white point	44
About white point	44
Using an existing white point	44
Creating a custom white point	45
Creating a white point using a Kelvin temperature	45
Creating a white point using a CIE color space	47
Adjusting for ambient light	50
About ambient light	50
Creating an ambient light setting	51
Using an existing ambient light setting	53
Deleting a custom white point or ambient light setting	54
Adjusting the gamma curve	55
Recalibrating your display	57
Recalibrating automatically	57

Using color settings	58
Saving settings	58
Using existing settings	60
Deleting a setting	61
Importing and exporting ColorSync profiles	61
Exporting a ColorSync profile	62
Importing a ColorSync profile	63

5 Using Sound and Video 65

Sound controls at a glance	65
About sound sources	66
Selecting a sound input source	67
Selecting a sound input port on your computer	67
Selecting a sound input source for the display	70
Selecting a sound output device	71
Routing display sound	73
Adjusting volume	74
Checking volume controls on your computer	74
Adjusting volume, treble, and bass on your display	77
Setting the alert sound	79
Installing an alert sound	80
Removing an alert sound	81
Recording an alert sound using the display's built-in microphone	81
Recording a video with sound	82
About video equipment	83
Using video equipment with your AppleVision 1710AV Display	84
Recording a video	86
Playing an audio CD on AppleVision 1710AV speakers	88

6 The Control Strip	91
What is the Control Strip?	91
How does the Control Strip differ from control panels?	92
Closing, opening, and resizing the Control Strip	92
Closing the Control Strip	92
Opening the Control Strip	92
Resizing the Control Strip	93
Using the Control Strip	93
Changing screen resolution	93
Changing color depth	94
Moving and hiding the Control Strip	95
Moving the Control Strip	95
Hiding the Control Strip	95
Defining a hot key for the Control Strip	96
Customizing the Control Strip	98
Rearranging the modules in the Control Strip	98
Changing the menu font	98
7 Tips and Troubleshooting for Macintosh Users	101
Care and cleaning	101
Protecting your display from theft	102
Troubleshooting	102

Part II Using the Display With Your IBM PC-Compatible Computer

8 Setting Up for IBM PC-Compatible Users 115

- Important safety and cleaning instructions 115
- Compatibility 117
- Getting ready to set up 118
 - Choosing a good location for your display 119
 - Positioning the display 119
- Connecting the display to your IBM PC-compatible computer 120
 - Connecting the power cord 121
 - Connecting the display cable 121
 - Connecting the sound cable 122
 - Connecting sound input equipment to your display 123
 - Connecting sound output equipment to your display 123
- Turning the display on 124
- Using the display 124

9 Adjusting the Screen Image 125

- Controls at a glance 126
- Using on-screen controls 127
- Adjusting screen geometry 128
 - Width 128
 - Height 128
 - Pincushion 128
 - Vertical Shift 128
 - Horizontal Shift 129
 - Rotate 129
 - Default 129

Adjusting color temperature and overscan	129
Color Temperature	130
Overscan	130
Scan Rate	130
Adjusting convergence	131
Vertical	131
Horizontal	131
10 Tips and Troubleshooting for IBM PC-Compatible Users	133
Care and cleaning	133
Protecting your display from theft	134
Troubleshooting	134

Part III Appendixes

A Working With ColorSync	141
The problem that ColorSync solves	141
About ColorSync	142
How ColorSync works	142
Using ColorSync	143
B Technical Information	145
Index	151

Communications regulation information

FCC Statement

This equipment has been tested and found to comply with the limits for a Class B digital device in accordance with the specifications in Part 15 of FCC rules. See instructions if interference to radio or television reception is suspected.

Radio and television interference

The equipment described in this manual generates, uses, and can radiate radio-frequency energy. If it is not installed and used properly—that is, in strict accordance with Apple’s instructions—it may cause interference with radio and television reception.

This equipment has been tested and found to comply with the limits for a Class B digital device in accordance with the specifications in Part 15 of FCC rules. These specifications are designed to provide reasonable protection against such interference in a residential installation. However, there is no guarantee that interference will not occur in a particular installation.

You can determine whether your computer system is causing interference by turning it off. If the interference stops, it was probably caused by the computer or one of the peripheral devices.

If your computer system does cause interference to radio or television reception, try to correct the interference by using one or more of the following measures:

- Turn the television or radio antenna until the interference stops.
- Move the computer to one side or the other of the television or radio.
- Move the computer farther away from the television or radio.
- Plug the computer into an outlet that is on a different circuit from the television or radio. (That is, make certain the computer and the television or radio are on circuits controlled by different circuit breakers or fuses.)

If necessary, consult an Apple-authorized service provider or Apple. See the service and support information that came with your Apple product. Or, consult an experienced radio/television technician for additional suggestions. You may find the following booklet helpful: *Interference Handbook* (stock number 004-000-00493-1). This booklet, prepared by the Federal Communications Commission, is available from the U.S. Government Printing Office, Washington, DC 20402.

IMPORTANT Changes or modifications to this product not authorized by Apple Computer, Inc., could void the FCC Certification and negate your authority to operate the product.

This product was tested for FCC compliance under conditions that included the use of Apple peripheral devices and Apple shielded cables and connectors between system components. It is important that you use Apple peripheral devices and shielded cables and connectors between system components to reduce the possibility of causing interference to radios, television sets, and other electronic devices. You can obtain Apple peripheral devices and the proper shielded cables and connectors through an Apple-authorized dealer. For non-Apple peripheral devices, contact the manufacturer or dealer for assistance.



DOC statement

DOC Class B Compliance This digital apparatus does not exceed the Class B limits for radio noise emissions from digital apparatus as set out in the interference-causing equipment standard entitled “Digital Apparatus,” ICES-003 of the Department of Communications.

Observation des normes—Classe B Cet appareil numérique respecte les limites de bruits radioélectriques applicables aux appareils numériques de Classe B prescrites dans la norme sur le matériel brouilleur : “Appareils Numériques”, NMB-003 édictée par le ministre des Communications.

VCCI statement

情報処理装置等電波障害自主規制について

この装置は、第二種情報装置（住宅地域又はその隣接した地域において使用されるべき情報装置）で住宅地域での電波障害防止を目的とした情報処理装置等電波障害自主規制協議会（VCCI）基準に適合しております。

しかし、本装置をラジオ、テレビジョン受信機に近接してご使用になると、受信障害の原因となることがあります。

取扱説明書に従って正しい取り扱いをしてください。



How Much of This Book Do I Have to Read?

This book is divided into parts. If you're using the AppleVision 1710AV Display with a Macintosh computer, see Part I. If you're using the AppleVision 1710AV Display with an IBM PC-compatible computer, see Part II. For detailed technical information, see Part III.

Before you begin

If you've purchased a new Macintosh computer along with the AppleVision 1710AV Display, refer to the setup instructions that came with your computer in addition to the instructions in this book.

For more information

If you have System 7.5 or later installed on your Macintosh, see Macintosh Guide for the latest information on using the software that came with your AppleVision 1710AV Display. Macintosh Guide provides step-by-step guidance for new or complex tasks.

When you request help from Macintosh Guide, it displays instructions on your screen and walks you through a task one step at a time. To open Macintosh Guide, choose Macintosh Guide from the Guide menu (marked with the  icon).

Using the Display With Your Macintosh Computer

- Chapter 1 Setting Up for Macintosh Users
- Chapter 2 Changing Resolutions and Saving Energy
- Chapter 3 Adjusting the Screen Image
- Chapter 4 Fine-Tuning Display Color
- Chapter 5 Using Sound and Video
- Chapter 6 The Control Strip
- Chapter 7 Tips and Troubleshooting for Macintosh Users

Part I of this book describes how to use the display with your Macintosh computer. To use the display with your IBM PC-compatible computer, see Part II.



part

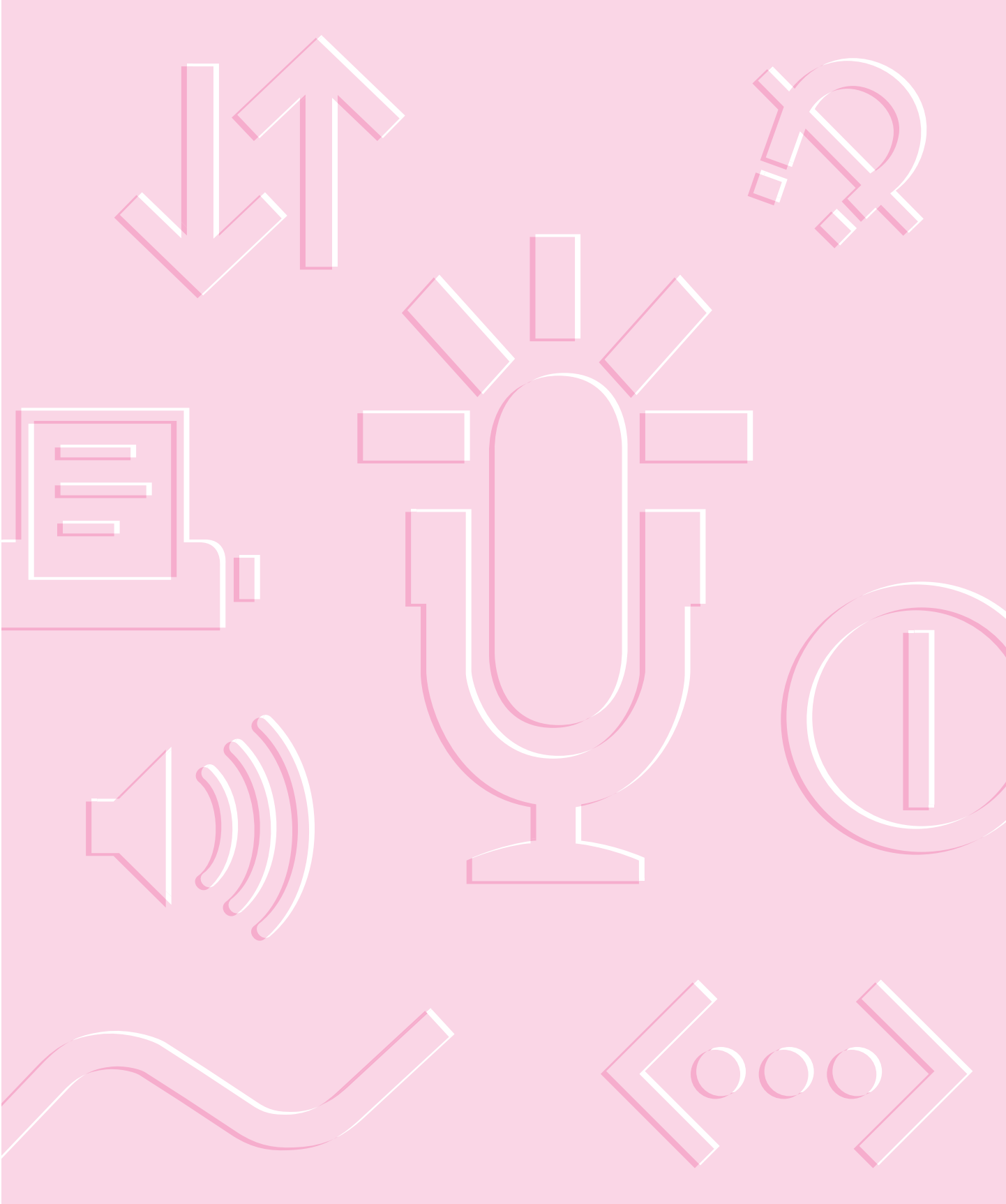

1

Setting Up for Macintosh Users



The AppleVision 1710AV Display is a full-page, Trinitron™ color monitor that supports a variety of resolutions. The display includes sound and video support for multimedia application programs and advanced controls for accurate color rendering. The AppleVision 1710AV Display has a diagonal viewable image size of 16.1 inches.

The instructions in this chapter discuss important safety information, setting up and connecting the display to your computer, and installing software on your computer.

The AppleVision 1710AV Display works with both Macintosh and IBM PC-compatible computers. If you're using your display with an IBM PC-compatible computer, refer to Part II, "Using the Display With Your IBM PC-Compatible Computer."

Important safety and cleaning instructions

WARNING Do not clean your display screen with a cleaner that contains alcohol or acetone. You might damage the screen. For more information about cleaning your display, see "Care and Cleaning" in Chapter 7.

For your own safety and that of your equipment, always take the following precautions.

Disconnect the display's power plug (by pulling the plug, not the cord) if any of the following conditions exists:

- the power cord or plug becomes frayed or otherwise damaged
- you spill something into the case
- your display is exposed to rain or any other excess moisture
- your display has been dropped or the case has been otherwise damaged
- you suspect that your display needs service or repair
- you want to clean the case (use only the recommended procedure described in “Care and Cleaning” in Chapter 7)

IMPORTANT The only way to disconnect power completely is to unplug the display's power cord. Make sure at least one end of the power cord is within easy reach so that you can unplug the display when you need to.

Be sure that you always:

- Keep your display away from sources of liquids, such as wash basins, bathtubs, shower stalls, beverages, and so on.
- Don't set anything on top of the display (such as a book or cup). The display could overheat and be damaged.
- Keep the display's vents free from obstruction.
- Protect your display from dampness or wet weather, such as rain, snow, and so on.
- Read all the installation instructions carefully before you plug your display into a power source.
- Keep these instructions handy for reference by you and others.
- Follow all instructions and warnings dealing with your system.

WARNING Never remove the cover from the display or you may come in contact with hazardous voltage levels capable of causing serious injury and possibly death.

WARNING Electrical equipment may be hazardous if misused. Operation of this product, or similar products, must always be supervised by an adult. Do not allow children access to the interior of any electrical product and do not permit them to handle any cables.

What about electromagnetic emissions?

There has been recent public discussion of the possible health effects of prolonged exposure to extremely low frequency (ELF) and very low frequency (VLF) electromagnetic fields. Such fields are associated with electromagnetic sources such as television sets, electrical wiring, and some household appliances—as well as computer displays.

Apple has reviewed scientific reports and sought the counsel of government regulatory agencies and respected health organizations. Based on the prevailing evidence and opinions, Apple believes that the electric and magnetic fields produced by computer displays do not pose a health risk.

In response to those customers who wish to reduce their exposure to electromagnetic fields, Apple has lowered the emission levels of Apple displays. We are also actively encouraging further scientific research so we can continue to promote the health and safety of our customers and employees.

Getting ready to set up

Before you set up your display system, make sure you have easy access to the following items that came with your AppleVision 1710AV Display:

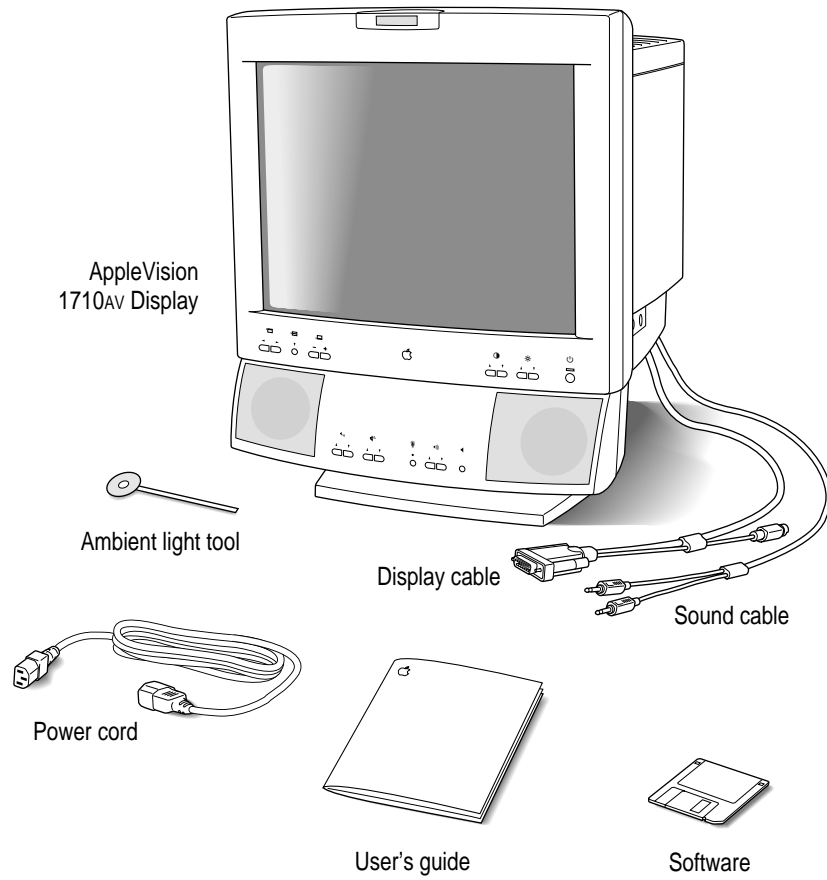

Your AppleVision 1710AV Display at a glance

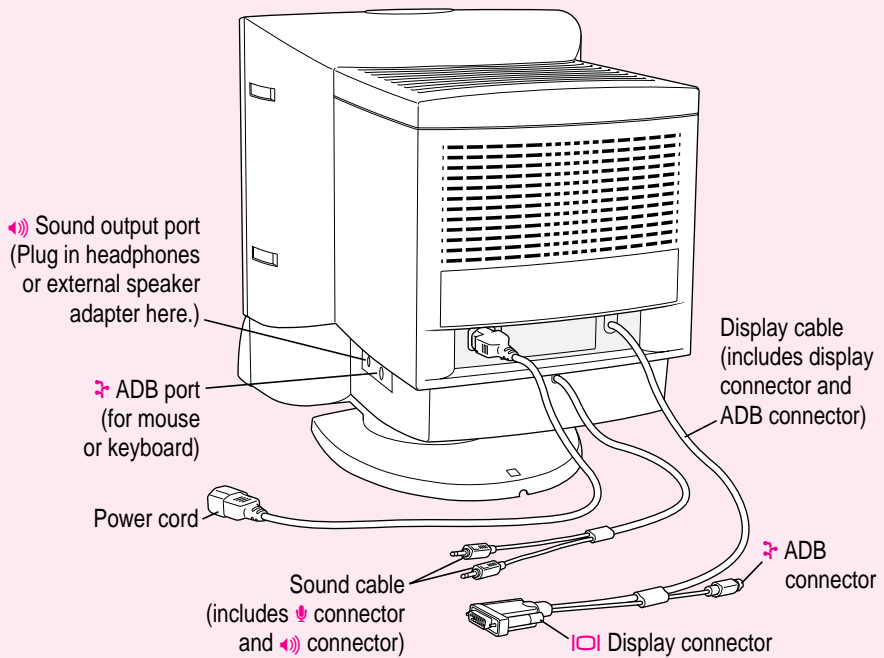
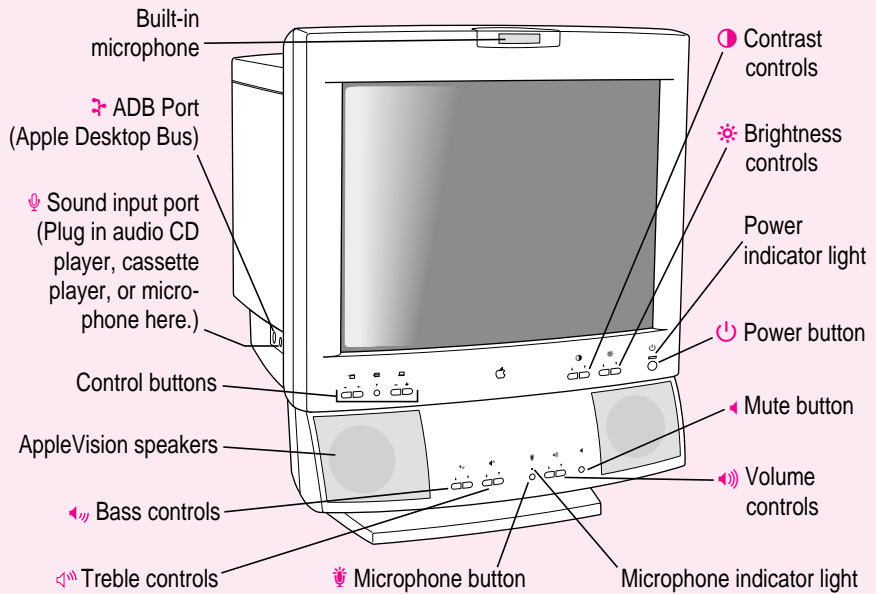

Choosing a good location for your display

Here are some key factors to consider when determining where to place your display:

- Be sure that the desk or table can support the display's weight—approximately 60 pounds (27 kilograms).
- Make sure that the power cord and display cable will reach from the back of the display to your computer.
- The display cable should be unobstructed when you swivel and tilt the display, so allow at least 7 inches (17.5 cm) of clearance in the back. If you don't allow enough clearance, the display connector might be damaged when the cable hits an obstruction.

Positioning the display

IMPORTANT When you unpack or move the display, don't set the display down at an angle; you might damage the display stand.

- 1 Place the display so the screen faces the user.**
- 2 To slide the display, lift the front up slightly and push or pull in the direction you want.**
- 3 Adjust the viewing angle of the display by tilting it up or down and turning it left or right on its stand.**

Position the display so that when you use it, no bright light is behind the display or reflected on the screen. Your eyes should be about level with the top edge of the screen and between 18 and 28 inches (45 to 70 cm) away. Take occasional breaks when using your computer to focus your eyes on a distant object.

Note: After you install the display, adjust the image and colors on the screen to match your environment. For example, in a bright room, contrast is usually best set at maximum; in a dim room, lower contrast is usually more comfortable. See Chapters 3 and 4 for more information on adjusting screen image and color.

For your greatest comfort, use the following illustration to help you in positioning your display.

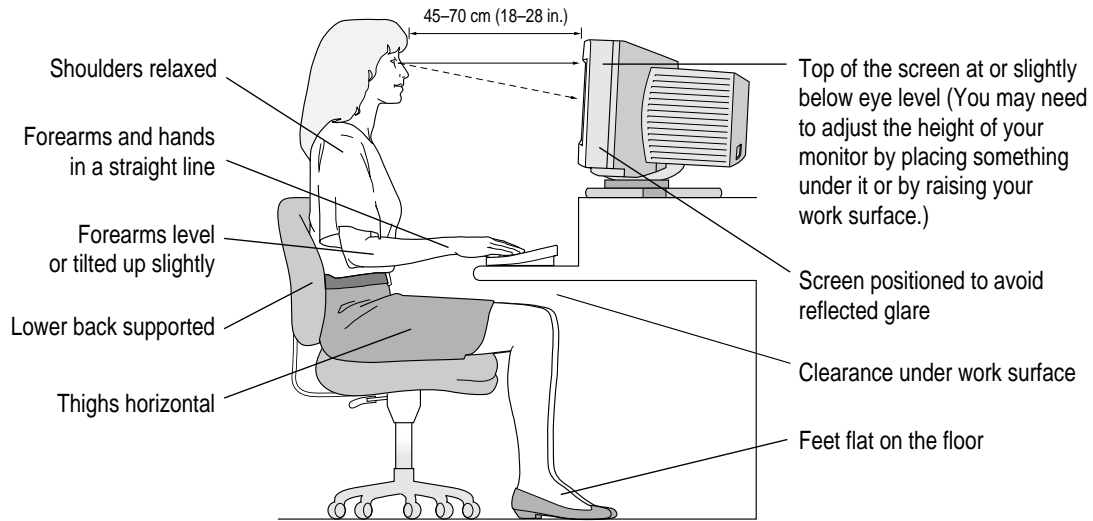

Do you need a video card?

To use the AppleVision 1710AV Display, you need compatible video circuitry built into your computer or a compatible video card installed in your computer. If you are unsure whether your computer has the appropriate built-in video capability, check with an Apple-authorized dealer or service provider.

If your computer does not have the video capability necessary to use this display, you need to purchase a video card. (Video cards are available from an Apple-authorized dealer or service provider.) Install the video card before you connect the display to your computer. To install a video card in one of the expansion slots inside your computer, see the manual that came with your computer or video card.

Using more than one display

If your computer has expansion slots, you can use the AppleVision 1710AV Display with one or more additional displays connected to your computer. You may need a video card for each additional display you are using. See the manual that came with your computer for more information.

Connecting the display to your Macintosh computer

Follow these steps to connect the AppleVision 1710AV Display to your computer.

IMPORTANT Before you connect any cords or cables, make sure your computer is turned off and unplugged.

WARNING This equipment is intended to be electrically grounded. Your display may be equipped with a three-wire grounding plug—a plug that has a third (grounding) pin. This plug will fit only a grounded AC outlet. This is a safety feature. If you are unable to insert the plug into the outlet, contact a licensed electrician to replace the outlet with a properly grounded outlet. Do not defeat the purpose of the grounding plug!

Connecting the power cord

- 1 Connect the socket end of the power cord to the power cord receptacle on the back of the display.

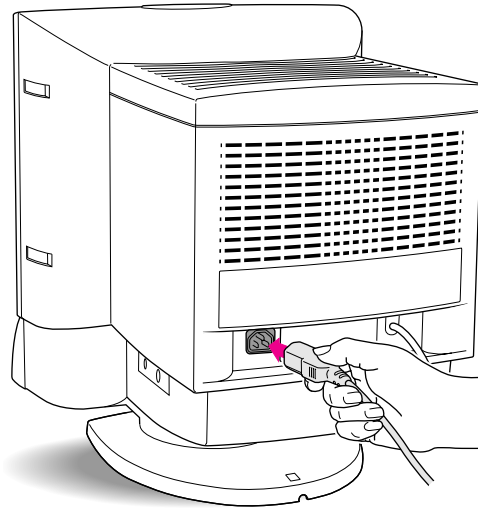

- 2 Plug the other end of the power cord into a grounded outlet or power strip.**

Note: You may have a power jumper cord instead of a power wall cord. In this case, plug the power jumper cord into the power socket on the back of your computer.

Connecting the display cable

The display cable on your AppleVision 1710AV Display is a split cable with two connectors, one for video and one for the Apple Desktop Bus (ADB).

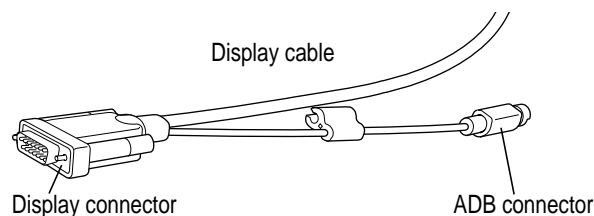

- 1 Plug the display connector on the display cable into the display port (marked by ) on the back of your computer.**

If your computer has more than one display port, see the manual that came with your computer for information on choosing the correct port.

If you installed a video card in your computer, connect the display connector on the display cable to the video card's port. For more information about installing video cards, see the manual that came with your computer or video card.



- 2 Tighten the thumbscrews on the connection.**

You can prevent bad connections and accidental damage by tightening the thumbscrews. Do not overtighten the thumbscrews; you might strip the threads.

- 3 Plug the ADB connector on the display cable into an ADB port (marked by ) on the back of your computer.**

Make sure the ADB connector is attached firmly. This connector is not optional; it's needed for your Macintosh computer to work correctly with the AppleVision 1710AV Display.

If you have only one ADB port on the back of your computer and you're already using it for your keyboard and mouse, unplug the keyboard and mouse and connect them directly to your AppleVision 1710AV Display. For more information, see “Connecting Your Keyboard and Mouse to the Display” later in this chapter.

Note: Make sure you don't plug the ADB connector into an S-video port (marked by  or ) by mistake. The ports are the same size and it's easy to mistake one for the other.

IMPORTANT When connecting ADB cables, be sure to align the symbol  on the connector with the same symbol on the port. If you force a connector the wrong way, you will damage it.

Connecting the display cable to a high-density port

To connect the display to a high-density port (45-pin port) instead of a standard display port (15-pin port), you'll need to use an adapter. This adapter is shipped with your computer. If you don't have an adapter, you can purchase one from an Apple-authorized dealer. For more information, see the manual that came with your computer.

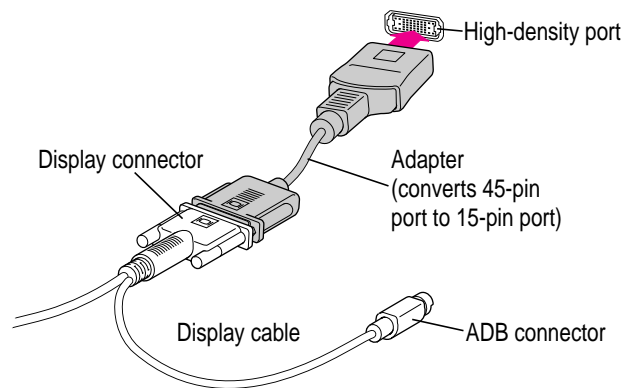

Note: The adapter shipped with your AppleVision 1710AV Display is for connecting your display to an IBM PC-compatible computer; it is not for connecting your display to a high-density port. For more information on connecting your display to an IBM PC-compatible computer, see Chapter 8.

Connecting the sound cable

The sound cable on your AppleVision 1710AV Display is a split cable with two connectors, one for sound input and one for sound output.

Plug these connectors into your computer if you want to use the built-in microphone and speakers on your AppleVision 1710AV Display.

- 1 **Plug the connector (marked by 🎙️) on the sound cable into the sound input port (marked by 🎙️) on the back of your computer.**

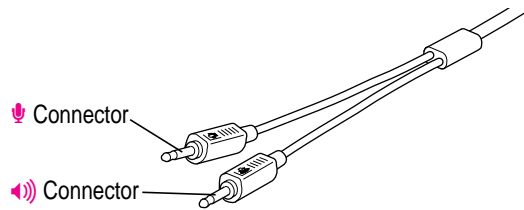

- 2 **Plug the connector (marked by 🔊) on the sound cable into the sound output port (marked by 🔊) on the back of your computer.**

Connecting your keyboard and mouse to the display

If you wish, you can plug your keyboard and mouse directly into the AppleVision 1710AV Display, rather than into the back of your computer. There is one ADB port on each side of the display for your keyboard and mouse (or any other ADB device).

IMPORTANT Always be sure your computer is shut down before you plug in or disconnect ADB cables.

- 1 **Make sure the ADB connector on the display cable is plugged into an ADB port (marked by ⌘) on the back of your computer.**

For more information, see “Connecting the Display Cable” earlier in this chapter.

- 2 **If necessary, unplug the keyboard or mouse cable from the ADB connector on the back of your computer.**

3 Decide how you want to connect the keyboard and mouse.

For example, you can connect your mouse cable to your keyboard and then connect the keyboard to one of the ADB ports (marked by ⌘) on either side of the display stand. Or, if you prefer, you can plug your keyboard and mouse cables into the ADB ports (marked by ⌘) on either side of the display stand.

4 Connect your keyboard and mouse cables to the display's ADB ports (marked by ⌘) according to your preference.

Connecting external sound equipment

The AppleVision 1710AV Display has two sound ports you can use to connect external sound equipment. The port on the left side of the display is for connecting sound input equipment (such as an audio CD player, cassette player, or microphone). The port on the right side of the display is for connecting sound output equipment (such as headphones or external speakers).

The display's sound output port (marked by 🎧) accepts a connector known as a *stereo miniplug*. This connector is the type used on headphones for most CD and cassette players.

The display's sound input port (marked by 🎤) accepts both the stereo miniplug connector and an extended version of the stereo miniplug. The extended stereo miniplug is slightly longer and is found on voice-quality microphones such as the Apple PlainTalk Microphone.

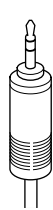

Stereo miniplug

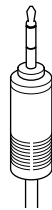



Extended stereo miniplug

If your equipment has a different type of connector, you can purchase an adapter at an electronics supply store.

Connecting sound input equipment to your display

To record sounds, you can use the built-in microphone on your AppleVision 1710AV Display, or you can connect external sound input equipment (such as an audio CD player, cassette player, or microphone) to the display.

To connect sound input equipment:



- 1** Make sure the connector (marked by ) on the sound cable is plugged into the sound input port (marked by ) on the back of your computer.
- 2** Plug the sound input equipment into the sound input port (marked by ) on the left side of the display.

Note: To use sound input equipment (such as an audio CD player, cassette player, or external microphone) you must select the correct sound input source in the AppleVision Setup control panel. For more information, see Chapter 5.

Connecting sound output equipment to your display

If you wish, you can plug a pair of headphones (or other sound output equipment) into the AppleVision 1710AV Display.

To plug your headphones into the display:

- 1** Make sure the connector (marked by ) on the sound cable is plugged into the sound output port (marked by ) on the back of your computer.
- 2** Plug the headphones into the sound output port (marked by ) on the right side of the display.

Turning the display on

To turn on the display for the first time:

- 1 Plug in the computer's power cord.**
- 2 Press the power button on the front right side of the display.**

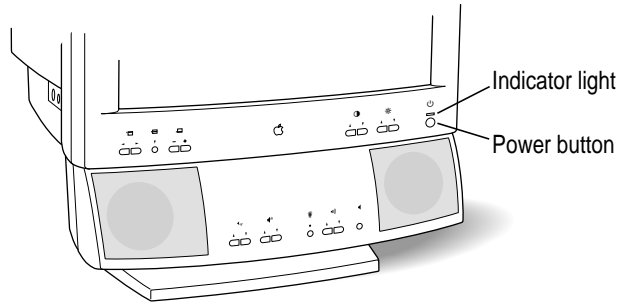

Note: The display's power indicator light doesn't go on until you start your computer.

- 3 Start your computer and wait a few seconds.**

The power indicator light goes on. If the power indicator light does not go on, press the display's power button again. If this doesn't work, make sure you've connected the display cable and power cord properly (see "Connecting the Display to Your Macintosh Computer" earlier in this chapter).

Also, make sure your computer is turned on and no energy-saving or screen-saving features are active. When Energy Saver is on, the power indicator light on the display does not go on. For more information on Energy Saver, see "Conserving Energy" in Chapter 2.

To make full use of the features available to you with this display, you must install the Macintosh software that came with your display.

Installing the Macintosh software

Note: Be sure you're acting within the terms of the software license agreement before you install this software on a computer. The license agreement specifies how many copies of the program you can make for yourself and others.

To install the display software on a Macintosh computer, follow these steps:

1 Make sure you have System 7.1 or later installed.

You need a Macintosh running System 7.1 or later to use the display software. If you don't have System 7.1 or later, contact an Apple-authorized dealer or service provider.

If your display is connected to an IBM PC-compatible computer, see Part II, "Using the Display With Your IBM PC-Compatible Computer."

2 Insert the *AppleVision Software* disk into a floppy disk drive.

The disk's icon appears on the desktop, as shown in the next step.

3 If necessary, double-click the disk icon to see what's on the disk.



The disk window may open automatically.

4 Double-click the Installer icon to start the Installer program.



After a moment, the Installer opens.

IMPORTANT The Installer checks to make sure you have the system software you need to use the display. If you're missing anything, a message tells you what you need. You won't be able to install the software until you correct the problem. If a dialog box says you don't have the correct system software, you can purchase a new version from an Apple-authorized dealer.

5 Click Install.



The Installer takes a few minutes to calculate what needs to be done and then begins to copy files.

Note: Make sure you use the Installer to install the software. Do not install the software by dragging files.

6 Follow the instructions on the screen until the installation is complete.

After the installation, the Installer tells you to restart your computer.

7 Click Restart.

The software is now installed and the display is ready for use.

Note: If you reinstall system software on your computer, you must reinstall the display software.

2

Changing Resolutions and Saving Energy



This chapter explains how to use the Macintosh software you installed to change screen resolutions and save energy.

Note: If you press a button on the front of your display and see the following controls on your screen instead of the standard Macintosh desktop, you probably haven't set up the AppleVision 1710AV Display correctly. See Chapter 1 for more information.

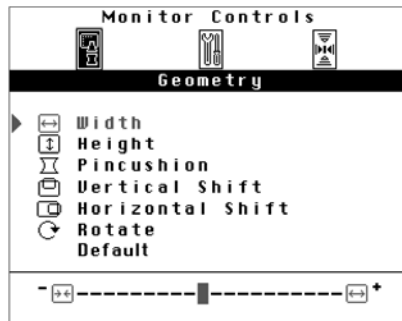

Changing screen resolution

You can change the resolution of your display to zoom in for detail work or to zoom out and see a whole page or more at a time. *Screen resolution* is the number of dots (or pixels) your display uses to create an image on the screen.

Note: Not all Macintosh computers can change screen resolution. For more information, see the manual that came with your computer.

To change your screen resolution, follow these steps:

- 1 **Choose Control Panels from the Apple () menu.**

A window opens showing all the control panels.

- 2 **Double-click the Monitors icon to open the Monitors control panel.**



IMPORTANT If the Monitors icon or Monitors control panel doesn't appear, you may have a different version of the AppleVision display software. In this case, instructions in this chapter don't apply. See Macintosh Guide for instructions on setting screen resolution. To open Macintosh Guide, choose Macintosh Guide from the Guide menu (marked with the ? icon).

- 3 **Make the following selections in the control panel:**

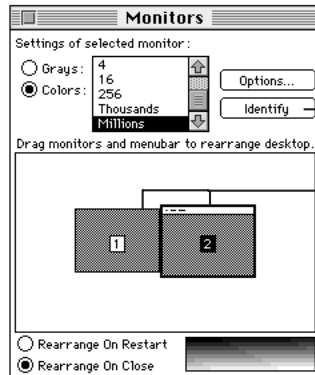

First, if you have more than one monitor, click here to see how your monitors are numbered.

Second, click the icon of the monitor you want to change. (If you only have one monitor, you will only see one choice.)

Note: The selections you see in the Monitors control panel depend on what hardware you have.

4 Click Options to see what resolutions you can select.

5 Select a resolution.

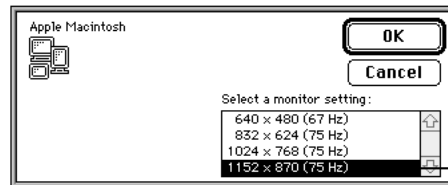

Click the resolution you want. Click the arrows to see if there are more choices. (Your choices may differ from those shown here.)

If you don't see any options for changing resolutions, you may have selected the wrong display in the control panel. Click Cancel, then try step 3 again. If you still don't see any options for changing resolutions, make sure you've set up the AppleVision 1710AV Display correctly. For more information, see Chapter 1.

The screen resolution you choose may change the number of colors and grays you can set for your monitor. With a higher resolution, you may have fewer choices for colors and grays.

6 Click OK to return to the main window of the Monitors control panel.

7 Close the Monitors control panel by clicking the close box in the upper-left corner.

Depending on the option you selected in the control panel, the new resolution appears either as soon as you close the dialog box or when you restart the computer.

When you change screen resolution, objects on your desktop may be rearranged to accommodate the new resolution.

8 If the image is distorted, adjust the controls on the display itself as explained in Chapter 3.

Other things you can do with the Monitors control panel

You can also use the Monitors control panel to

- arrange how multiple displays work together
- select how many colors or shades of gray each display can show

See the instructions that came with your computer for details.

Using the Control Strip

You can also use the Control Strip to change the resolution of your display. See Chapter 6 for more information.



Conserving energy

Use the Energy Saver control panel to tell the display whether to conserve energy after a specified period of inactivity.

You can use the control panel with your AppleVision 1710AV Display or any other Apple display that complies with the United States Environmental Protection Agency's Energy Star program. (Look for the EPA Energy Star logo on the display box.)

Note: When you save energy, you save natural resources and reduce pollution. Although the AppleVision 1710AV Display contains features that automatically save energy, you can increase the energy savings by turning the computer off if you won't be using it for a while—for example, overnight or over the weekend.

To use the control panel, follow these steps:

- 1 Choose Control Panels from the Apple () menu.**

A window opens showing all the control panels.

2 Double-click the Energy Saver icon to open the Energy Saver control panel.

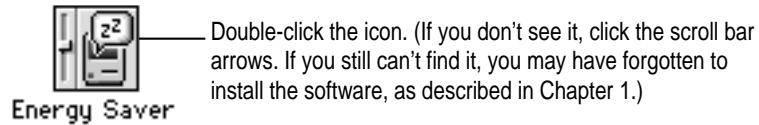

3 Make the following choices in the control panel:

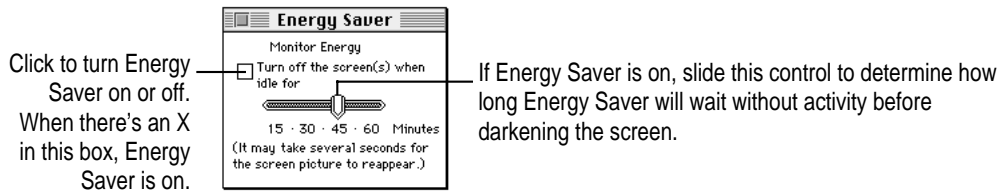

IMPORTANT If you've installed the Macintosh software that came with your computers and the Energy Saver icon still doesn't appear or the Energy Saver control panel doesn't look like the one above, you may have a different type of energy-saving software. In this case, instructions in this chapter don't apply. See Macintosh Guide for instructions on saving energy. To open Macintosh Guide, choose Macintosh Guide from the Guide menu (marked with the  icon).

Note: Not all Macintosh computers work with Energy Saver. See "Troubleshooting" in Chapter 7 for more information.

4 Close the control panel.

IMPORTANT If you use Energy Saver, make sure you turn it off when you're doing disk-intensive tasks such as copying a large number of files, downloading large files from an online service, or printing a very large file. If Energy Saver is activated during a disk-intensive task, the task may be terminated prematurely and you may need to recopy or reprint a file.

What happens after you turn on the energy-saving feature

When Energy Saver detects that you're not using the computer, it darkens the display screen and reduces the amount of energy it consumes. While the display is darkened, your computer is still working, but to avoid accidental changes, Energy Saver won't let anything you type or do with the mouse affect any of your work.

To “wake up” the display, move the mouse or press any key on the keyboard. Your computer beeps while the display is waking up—about 20 seconds—and you can begin work as soon as the computer stops beeping. (The beep volume cannot be adjusted; it is independent of all system sound controls.)

IMPORTANT The Energy Saver control panel works with Apple displays (such as this one) that comply with the EPA's Energy Star program and any other display that complies with the Video Electronics Standards Association's Display Power Management Standard. Other displays will darken after the specified inactivity period has passed, but they won't save energy.

Using Energy Saver with a screen saver

Screen savers are programs you can purchase that put moving patterns on your display. Both screen saver programs and the Energy Saver control panel prevent screen “burn-in.” Energy Saver also conserves energy.

If you wish, you can use both Energy Saver and a screen saver program. Set the screen saver to come on before Energy Saver. If your screen saver program includes its own energy-saving feature, you can remove Energy Saver from the Control Panels folder.

3

Adjusting the Screen Image



This chapter describes how to adjust the screen image on the AppleVision 1710AV Display. In most cases, you won't need to adjust the screen image unless you make changes to screen resolution.

Screen controls at a glance

The buttons on the front of your display provide a quick way to adjust the screen image.

Control buttons
Press any button to open the AppleVision Setup control panel.

Contrast controls
Press ▲ to increase contrast, press ▼ to decrease contrast.

Brightness controls
Press ▲ to increase brightness, press ▼ to decrease brightness.

Power button
Press to turn power on or off.

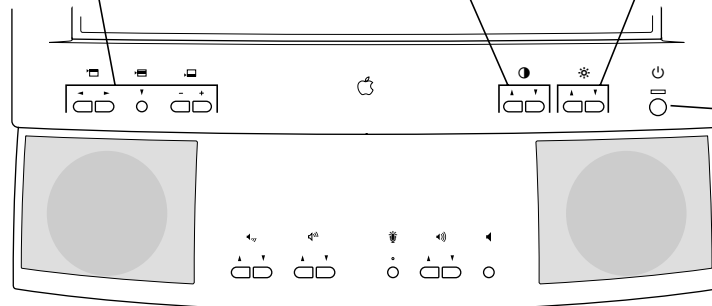

The Contrast and Brightness adjustments have an on-screen indicator that appears when you press a button on the front of your display. For example, pressing a Brightness button displays the Brightness indicator.

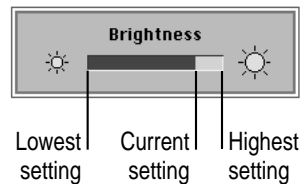

When you make an adjustment, the indicator bar moves to show the current setting. When you've finished making adjustments, the indicator disappears automatically.

You can use the AppleVision Setup control panel to lock out the contrast and brightness buttons. For more information, see "Recalibrating Automatically" in Chapter 4. If an adjustment is locked out, the indicator looks like this:

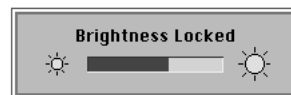

Using the AppleVision Setup control panel

In addition to the buttons on the front of your display, you can use the AppleVision Setup control panel to adjust the screen image.

Opening and closing the AppleVision Setup control panel

- 1 Choose Control Panels from the Apple () menu.
A window opens showing all the control panels.
- 2 Locate the AppleVision Setup icon in the Control Panel window.



AppleVision Setup

You may need to scroll to see the icon in the window.

If the AppleVision Setup icon doesn't appear, make sure you've installed the Macintosh software that came with your AppleVision 1710AV Display. For more information, see "Installing the Macintosh Software" in Chapter 1.

IMPORTANT If you've installed the Macintosh software that came with your display and the AppleVision Setup icon still doesn't appear, you may have a different version of the software. If this is the case, see Macintosh Guide for instructions on adjusting the screen image. To open Macintosh Guide, choose Macintosh Guide from the Guide menu (marked with the  icon).

3 Double-click the AppleVision Setup icon to open the AppleVision Setup control panel.

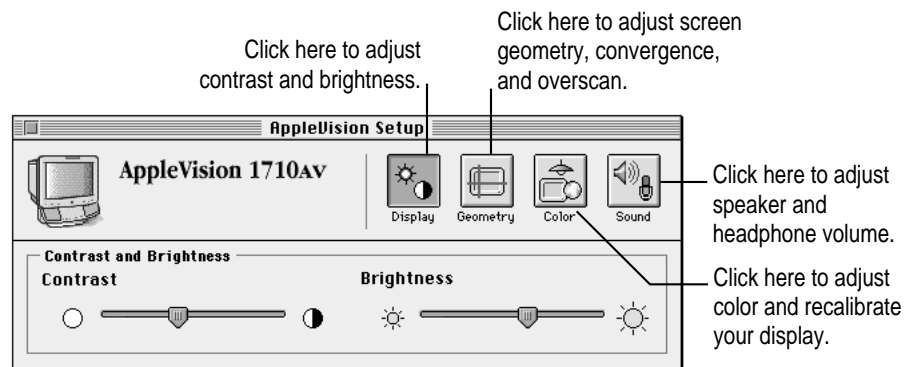

The AppleVision Setup control panel has four windows: Display, Geometry, Color, and Sound. The next sections describe how you use these windows to make screen image adjustments. For information on making color adjustments, see Chapter 4. For information on making sound adjustments, see Chapter 5.

4 When you've finished making adjustments, close the AppleVision Setup control panel.

Click the close box in the upper-left corner of the control panel, or choose Close from the File menu.

Automatically opening the AppleVision Setup control panel

You can open the AppleVision Setup control panel automatically by pressing a Control button on the front of your display.

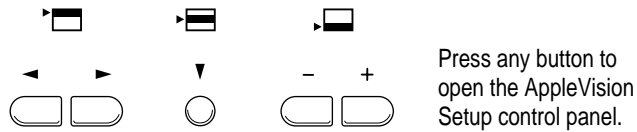

If you're using the AppleVision 1710AV Display with an IBM PC-compatible computer, these buttons allow you to select items from a set of on-screen controls. For more information, see Chapter 9.

If you see the following controls on your screen instead of the AppleVision Setup control panel, you probably haven't set up the AppleVision 1710AV Display correctly. See Chapter 1 for more information.

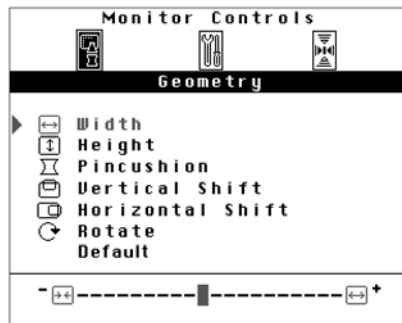

Note: If you rename the AppleVision Setup control panel or move it out of the Control Panels folder, the control panel will not open when you press a Control button.

Using more than one display

When you open the AppleVision Setup control panel, the name of your display appears near the top of the control panel. If you have more than one display attached to your computer, a control panel appears on each display that supports the AppleVision Setup software.

For example, if you have an AppleVision 1710AV Display and an AudioVision 14 Display attached to your computer, an AppleVision Setup control panel appears on each display and the name of the display is listed near the top of the panel. Changes you make in a control panel apply only to the display listed near the top of the panel.

If you have an AppleVision 1710AV Display and another display that doesn't support the AppleVision Setup software, the control panel only appears on the AppleVision 1710AV Display.

Adjusting the screen image

If you change your screen resolution, you may need to adjust the image on your display.

Adjusting contrast and brightness

Use the Display window in the AppleVision Setup control panel to adjust contrast and brightness.

- 1 Press a Control button on the front of your display (or open the AppleVision Setup control panel from the Apple [🍏] menu).**

The AppleVision Setup control panel appears.

- 2 Click the Display button.**



Display

The Display window appears. This window contains a slider for adjusting screen contrast and a slider for adjusting brightness.

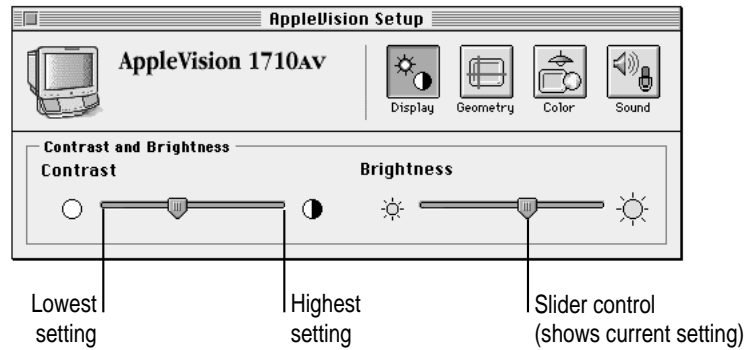

3 To adjust contrast, drag the slider control on the Contrast slider.

Dragging to the left decreases the contrast. Dragging to the right increases the contrast.

Note: If you drag the Contrast slider control to the minimum setting, the screen may be too dark to use the AppleVision Setup control panel. If this happens, use the buttons on the front of the display to increase contrast.

4 To adjust brightness, drag the slider control on the Brightness slider.

Dragging to the left decreases the brightness. Dragging to the right increases the brightness.

In addition to dragging, you can select a brightness or contrast setting by moving the pointer over the slider and clicking the mouse button.

5 When you've finished adjusting contrast and brightness, you can make another screen image adjustment or close the AppleVision Setup control panel.

Note: You can also use the buttons on the front of your display to adjust contrast and brightness. See “Screen Controls at a Glance” earlier in this chapter.

Adjusting height and width

When the height and width are set properly, you should be able to see the entire image on the screen with no distortion at the edges. If this is not the case, use the AppleVision Setup control panel to make this adjustment.

Note: If you're using the AppleVision 1710AV Display in an area that has a high level of electromagnetic interference from other equipment (for example, from another display or unshielded speakers), you may not be able to get perfect screen geometry.

- 1 Press a Control button on the front of your display (or open the AppleVision Setup control panel from the Apple [⌘] menu).

The AppleVision Setup control panel opens.

- 2 Click the Geometry button.



The Geometry window appears.

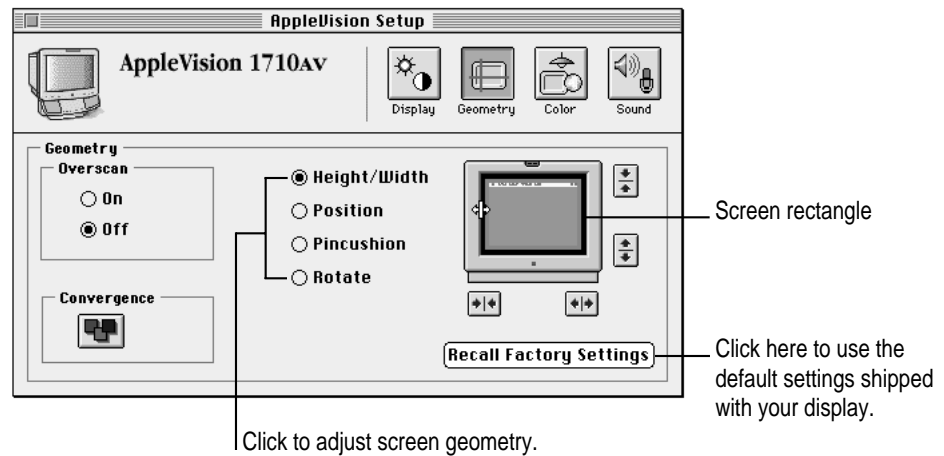

- 3 Click Height/Width.

4 Move the pointer over the screen rectangle in the picture of the display.

The pointer changes to indicate you're making a height or width adjustment. On the left and right sides of the screen rectangle, the pointer changes to a left/right arrow. On the top or bottom of the screen rectangle, the pointer changes to an up/down arrow.

5 Change the width of the screen image by dragging the left or right side of the screen rectangle.

As you drag the rectangle, the screen image on your AppleVision 1710AV Display changes width.

6 Change the height of the screen image by dragging the top or bottom edge of the screen rectangle.

As you drag, the image on your AppleVision 1710AV Display changes height.

In addition to dragging, you can adjust height and width by clicking the arrow buttons next to the picture. Each click makes a small change to the screen image. To repeat the adjustment, hold down the mouse button instead of clicking.

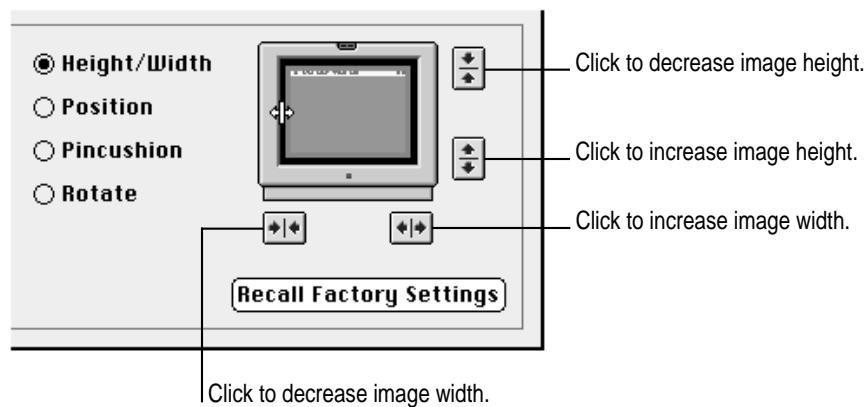

When the height and width are set properly, you should be able to see the entire image on the screen with no distortion at the edges.

7 When you've finished adjusting height and width, you can make another screen image adjustment or close the AppleVision Setup control panel.

Centering the screen image

The screen image on your display should have an equal border around all edges of the image. If this is not the case, use the AppleVision Setup control panel to make this adjustment.

- 1 Press a Control button on the front of your display (or open the AppleVision Setup control panel from the Apple [🍏] menu).

The AppleVision Setup control panel opens.

- 2 Click the Geometry button.

The Geometry window appears.

- 3 Click Position and move the pointer over the picture of the display.

The pointer changes to a hand when you move it over the picture.

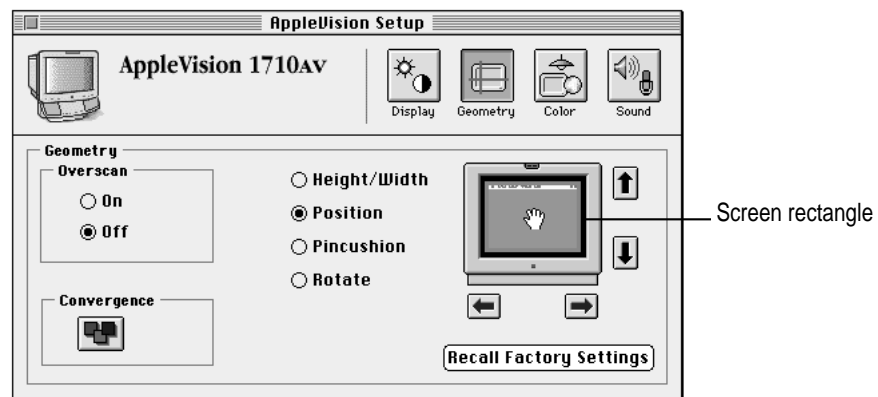

- 4 Center the image by dragging the screen rectangle to the desired location.

The screen image should have an equal border around all edges of the image.

In addition to dragging, you can center the image by clicking the arrow buttons next to the picture. Each click makes a small change to the screen image. To repeat the adjustment, hold down the mouse button instead of clicking.

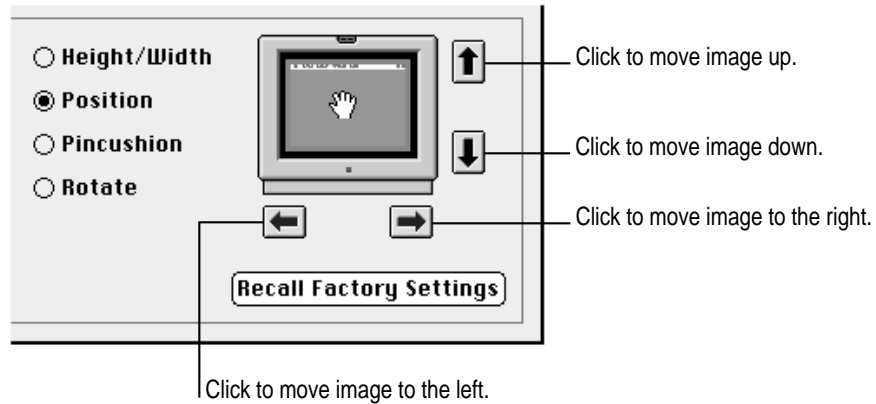

- 5 When you've finished centering the image, you can make another screen image adjustment or close the AppleVision Setup control panel.

Adjusting the shape of the screen image

When the shape of the screen image is set properly, the left and right sides of the image are straight and the image is rectangular. If this is not the case, use the AppleVision Setup control panel to make this adjustment.

- 1 Press a Control button on the front of your display (or open the AppleVision Setup control panel from the Apple [🍏] menu).

The AppleVision Setup control panel opens.

- 2 Click the Geometry button.

The Geometry window appears.

- 3 Click Pincushion and move the pointer over the picture of the display.

The pointer changes to indicate you're making an adjustment to the shape of the screen image.

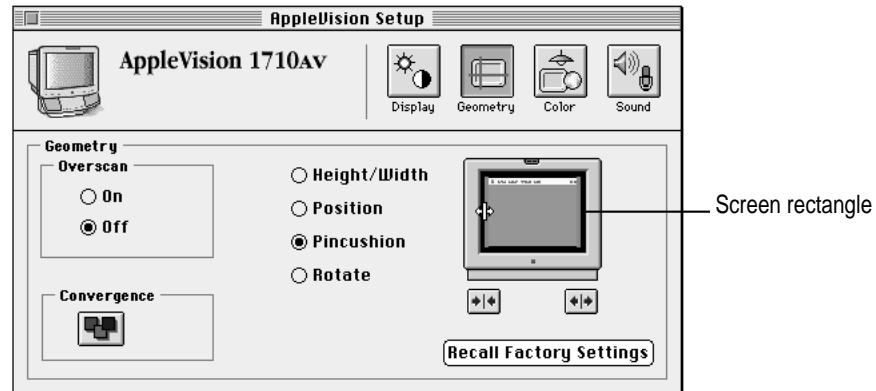

- 4 Drag the left or right side of the screen rectangle to adjust the screen image.

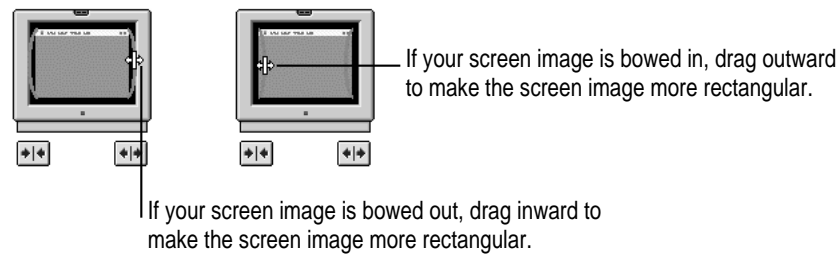

In addition to dragging, you can adjust the shape of the screen image by clicking the arrow buttons beneath the picture. Each click makes a small change to the screen image. To repeat the adjustment, hold down the mouse button instead of clicking.

- 5 When you've finished adjusting the shape of the screen image, you can make another screen image adjustment or close the AppleVision Setup control panel.

Rotating the screen image

When the rotation of the screen image is set properly, all four sides of the image are parallel to the edges of the screen and the image is rectangular. If this is not the case, use the AppleVision Setup control panel to make this adjustment.

- 1 **Press a Control button on the front of your display (or open the AppleVision Setup control panel from the Apple [] menu).**

The AppleVision Setup control panel opens.

- 2 **Click the Geometry button.**

The Geometry window appears.

- 3 **Click Rotate and move the pointer over the picture of the display.**

The pointer changes to a hand when you move it over the picture.

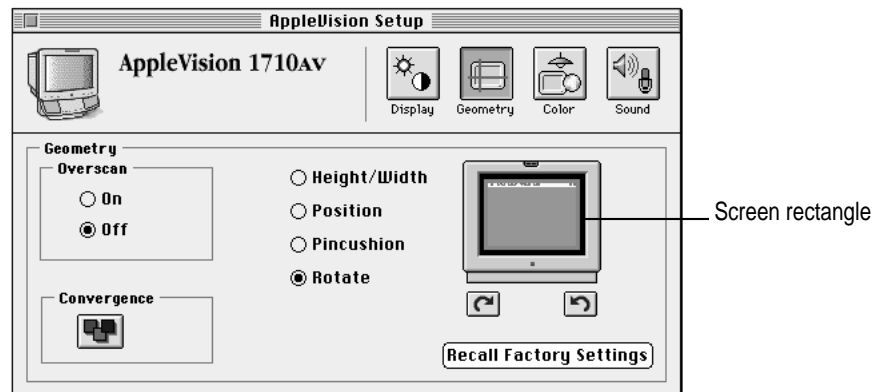

- 4 **Rotate the screen image by dragging the screen rectangle.**

When you drag the rectangle, the screen image rotates around an invisible center point. For example, dragging the right side of the rectangle upward rotates the screen image counterclockwise.

In addition to dragging, you can rotate the screen image by clicking the arrow buttons beneath the picture. Each click makes a small change to the screen image. To repeat the adjustment, hold down the mouse button instead of clicking.

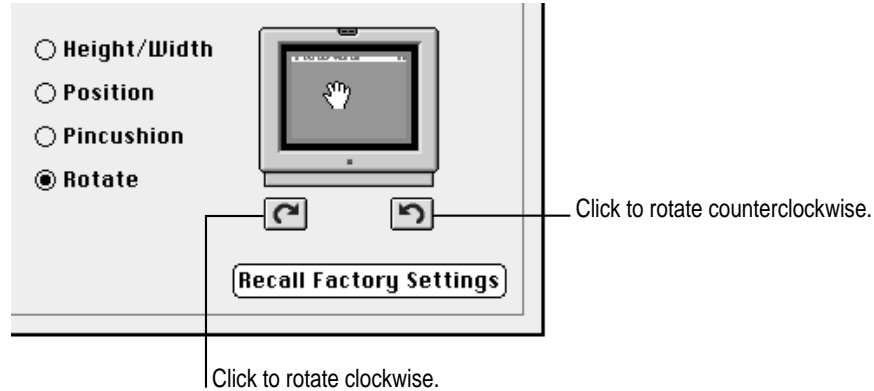

- 5** When you've finished rotating the screen image, you can make another screen image adjustment or close the AppleVision Setup control panel.

Adjusting convergence

Red, green, and blue signals in your display intersect, or *converge*, to create the colors you see on your screen. If the convergence is not set properly, images or text on your screen may appear blurred, or you may get a "rainbow" effect in which several colors form the edges of images on the screen.

Over time, you may need to change the convergence to get a clear, distinct screen image.

To adjust convergence:

- 1** Press a Control button on the front of your display (or open the AppleVision Setup control panel from the Apple [⌘] menu).

The AppleVision Setup control panel opens.

2 Click the Geometry button.

The Geometry window appears.

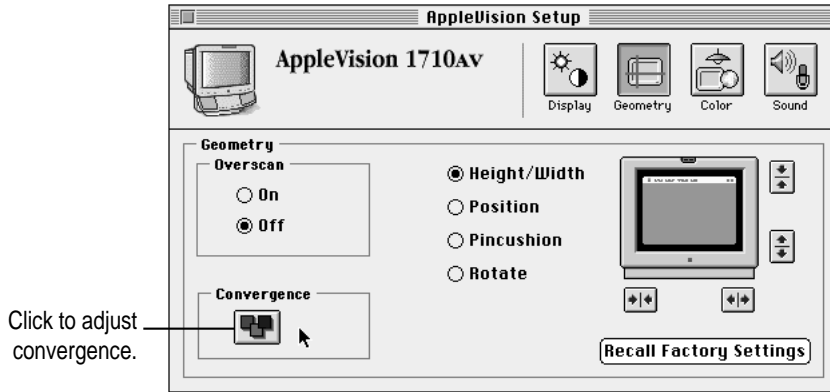

3 Click the Convergence button.

The Convergence Control window appears and your screen background changes to show a grid of red, green, and blue signals. When convergence is set properly, the signals in the grid are aligned vertically and horizontally.

IMPORTANT When you adjust convergence, refer to the grid outside the Convergence Control window, not the picture of the grid inside the window.

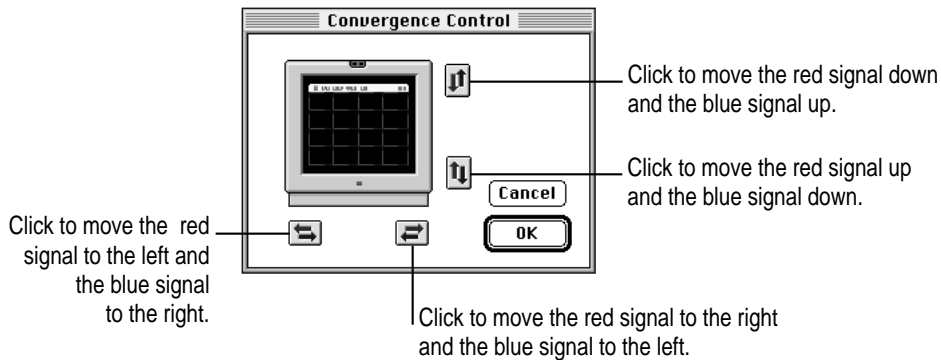

- 4 If necessary, move the Convergence Control window away from the center of your screen.**

When you adjust convergence, it's best to use the center of the screen image as a reference point, rather than the outside edges. You may have to compromise between good convergence at the center of the screen image and good convergence at the edges.

- 5 Use the horizontal and vertical arrows to adjust the convergence.**

When convergence is set properly, the image is clear and distinct. For example, you can make sure the lines in the title bar of the Convergence Control window don't overlap or blur.

- 6 Click OK.**

Your convergence changes are saved and the Convergence Control window disappears.

- 7 You can make another screen image adjustment or close the AppleVision Setup control panel.**

Turning overscan on and off

Overscan moves the screen image as far to the edges of the screen as possible. This setting is not recommended for normal Macintosh use, but can be useful for viewing video.

To turn overscan on and off:

- 1 Press a Control button on the front of your display (or open the AppleVision Setup control panel from the Apple [⌘] menu).**

The AppleVision Setup control panel opens.

- 2 Click the Geometry button.**

The Geometry window appears.

- 3 To turn overscan on, click On.

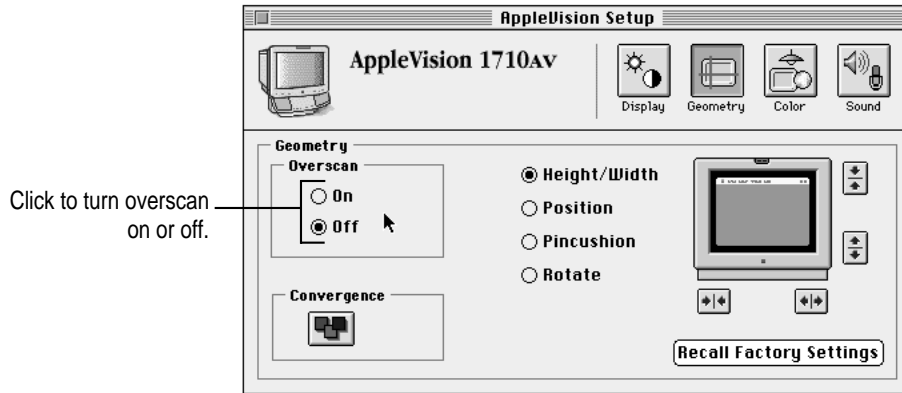

The screen image expands until there is a smaller black border between the image and the edge of the screen.

Note: When overscan is on, you cannot adjust screen geometry or convergence.

- 4 To turn overscan off, click Off.

The screen image returns to its previous size.

- 5 Close the AppleVision Setup control panel.

IMPORTANT When overscan is on, you may not be able to choose commands from the menus at the top of your display. If this occurs, you can't use a menu to open AppleVision Setup control panel and turn overscan off. Instead, open the AppleVision Setup control panel by pressing a Control button on the front of your display.

Resetting screen image to original levels

The screen image for your display is set at the factory. You can make adjustments if necessary (see “Adjusting the Screen Image” earlier in this chapter). Later, if you decide you want to change back to the factory preset levels, you can reset the following:

- screen geometry (height, width, centering, shape, rotation)
- convergence

To restore the screen image:

- 1 Press a Control button on the front of your display (or open the AppleVision Setup control panel from the Apple [🍏] menu).**

The AppleVision Setup control panel opens.

- 2 Click the Geometry button.**

The Geometry window appears.

- 3 Click Recall Factory Settings.**

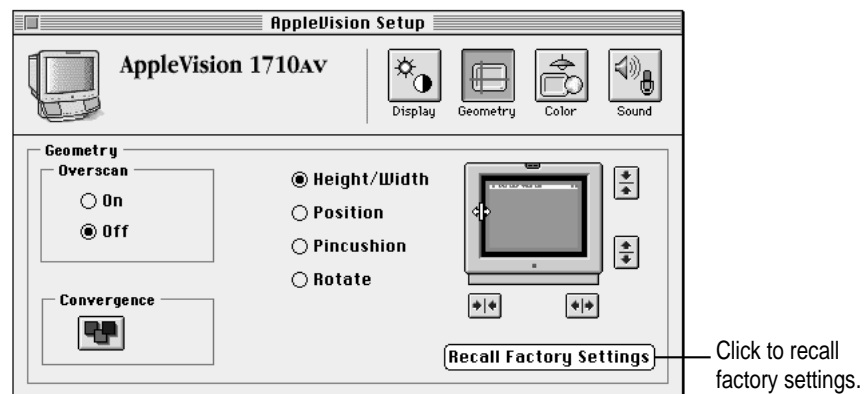

Your screen image returns to the factory preset levels for the current screen resolution. Controls that are reset are screen geometry and convergence. Adjustments you make in the Color window of the AppleVision Setup control panel are not reset.

- 4 Close the AppleVision Setup control panel.**

4

Fine-Tuning Display Color



This chapter describes how to fine-tune the color on your AppleVision 1710AV Display. In most cases, you won't need to adjust colors. However, if you're working with detailed color graphics, you may need to match display colors as closely as possible to colors created by a printer or other device.

About color

Your Apple computer system uses an additive process (a combination of red, green, and blue lights) to create display colors and a subtractive process (cyan, magenta, yellow, and black inks) to create printer colors. Because of the differences in these processes, the display and printer must be *characterized* to provide the best color match.

Your display comes with a general profile, called a ColorSync profile, that characterizes your display. The ColorSync software included with your display uses this display profile along with other device profiles to match colors as closely as possible. For more information about ColorSync and ColorSync profiles, see Appendix A.

To refine this color profile, you can use the Color window in the AppleVision Setup control panel to further characterize your specific display and lighting conditions.

These conditions include:

- *Brightness and contrast*: Changes to these settings can impact color. The higher the brightness setting for your screen, the more washed-out the colors may appear.
- *Ambient light*: The light surrounding your display may change how colors appear. For example, colors look different in sunlight than in fluorescent light.
- *Gamma curve*: The relationship between the input value and output luminance on your display is represented by *gamma curve*. At a low gamma value, colors are washed out. At a higher gamma value, colors have more contrast.
- *White point*: The white point you select for your display sets the mix of red, green, and blue lights that make the color white. When the white point changes, display colors change. For more information, see “About White Point” later in this chapter.
- *Display age*: Over time, your display may become less efficient, causing colors to change.

With the AppleVision 1710AV Display, you create a controlled color environment that takes these conditions into consideration and makes the appropriate adjustments. Combined with Apple’s ColorSync color-matching system, these settings ensure the closest match possible between display color and printed color.

Opening the Color window

Use the Color window in the AppleVision Setup control panel to adjust colors on your display.

- 1 **Press a Control button on the front of your display (or open the AppleVision Setup control panel from the Apple [🍏] menu).**

The AppleVision Setup control panel appears.

2 Click the Color button.



The Color window in the AppleVision Setup control panel appears.

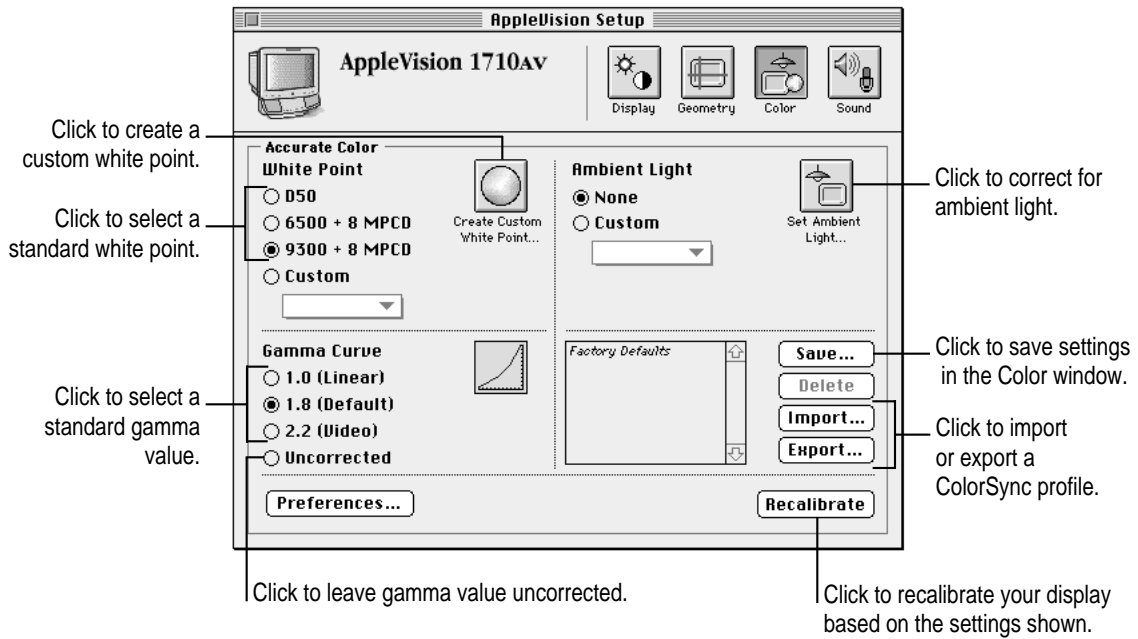

Note: If you have more than one display attached to your computer, the settings in the AppleVision Setup control panel apply only to the display listed near the top of the panel. For more information, see “Using More Than One Display” in Chapter 3.

3 Make color adjustments as desired.

The following sections describe color adjustments you can make to your AppleVision 1710AV Display.

IMPORTANT When you make color adjustments, the changes don’t take effect until you click Recalibrate.

Setting a white point

About white point

All lights, including display light, have a white point. *White point* is a measure of the color content of the light. Midday sun has a color temperature, or white point, of 6500 degrees Kelvin (sometimes represented as D65). *Kelvin* is a temperature scale used in scientific applications.

Lighting used in graphic arts is based on a white point of 5000 degrees Kelvin (or D50). Other common white points are 9300 degrees Kelvin (a standard for computer displays), 4100 degrees Kelvin (halogen light), and 3300 degrees Kelvin (fluorescent light).

With the AppleVision 1710AV Display, you can use an existing white point or create a custom white point based on popular color standards. For information on creating a custom white point, see “Creating a Custom White Point” later in this chapter.

Using an existing white point

- 1 Open the AppleVision Setup control panel and click the Color button.

The Color window appears.

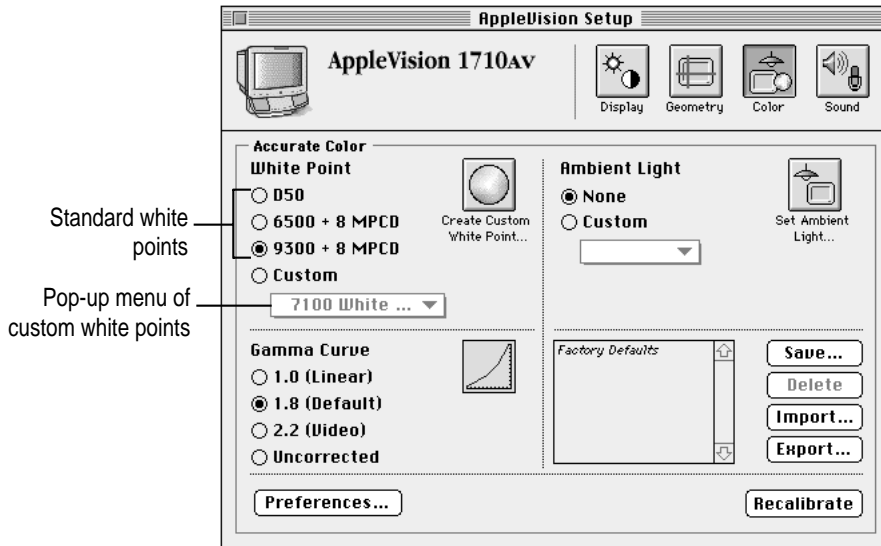

2 Select a standard white point or choose a white point from the White Point pop-up menu.

The white point buttons show standard, predefined white points. The choices are:

- *D50*: A standard for graphic arts work.
- *6500 + 8 MPCD*: Equivalent to midday sun.
MPCD stands for Minimum Perceptible Color Difference.
- *9300 + 8 MPCD*: A standard white point used by most Macintosh computer displays and high-definition television (HDTV).

The Custom White Point pop-up menu shows a list of custom white points created for your display. For more information, see the next section, “Creating a Custom White Point.”

3 Click Recalibrate.

After several seconds, your display is recalibrated using the white point you selected.

4 After you've selected a white point, you can make another color adjustment or close the AppleVision Setup control panel.

After you select a white point, it's a good idea to adjust for ambient light. See “Adjusting for Ambient Light” later in this chapter.

Creating a custom white point

You can create a custom white point based on a Kelvin temperature or popular color standards.

Creating a white point using a Kelvin temperature

1 Open the AppleVision Setup control panel and click the Color button.

The Color window appears.

- 2 Click the Create Custom White Point button.



A dialog box appears.

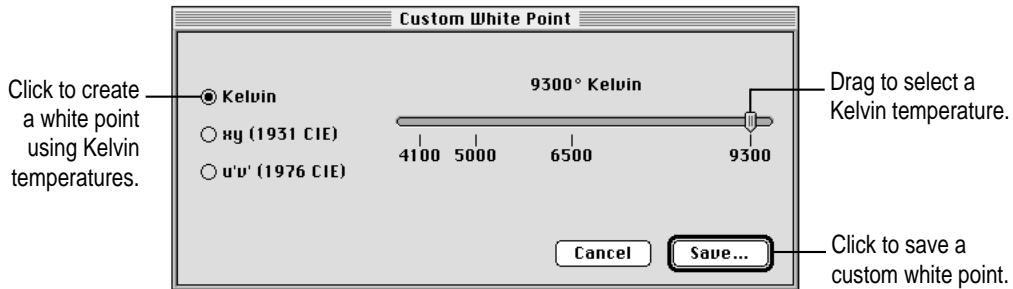

- 3 Make sure Kelvin is selected.

By default, Kelvin is selected and a Kelvin temperature slider appears in the dialog box.

- 4 Move the slider control to the desired temperature.

You can set any white point between 4100 degrees Kelvin and 9300 degrees Kelvin. Lower temperature settings create reddish whites and higher temperature settings create bluer whites.

- 5 Click Save.

A dialog box appears.

- 6 Enter a name for your custom white point and click Save.

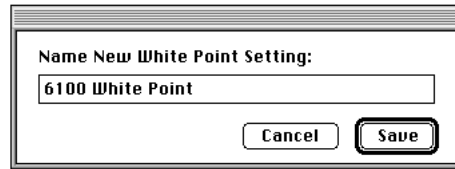

The custom white point is saved, and the name appears in the Custom White Point pop-up menu.

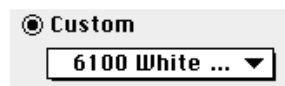

- 7 Click Recalibrate.

After several seconds, your display is recalibrated using the white point you created.

- 8 After you've created a custom white point, you can make another color adjustment or close the AppleVision Setup control panel.

After you create custom a white point, it's a good idea to adjust for ambient light. See "Adjusting for Ambient Light" later in this chapter.

Creating a white point using a CIE color space

The two most popular industry standards for defining colors are:

- *1931 CIE color space*: This standard uses a color space defined by x, y coordinates. This standard was created in 1931 by the Commission International de l'Eclairage (CIE), the International Commission on Illumination.
- *1976 CIE color space*: This standard uses a color space defined by u', v' coordinates. This standard was created in 1976 by the Commission International de l'Eclairage (CIE).

You can create a custom white point using either CIE standard.

- 1 **Open the AppleVision Setup control panel and click the Color button.**

The Color window appears.

- 2 **Click the Create Custom White Point button.**

A dialog box appears.

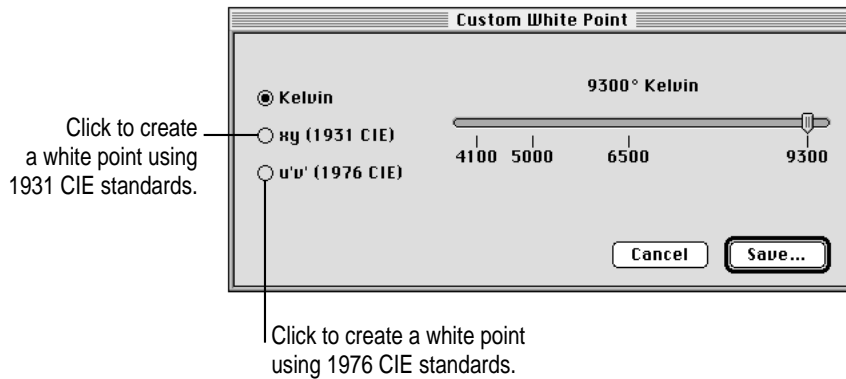

- 3 **Select either the xy (1931 CIE) button or the u'v' (1976 CIE) button.**

If you select the xy (1931 CIE) button, a representation of the 1931 CIE color space appears in the dialog box.

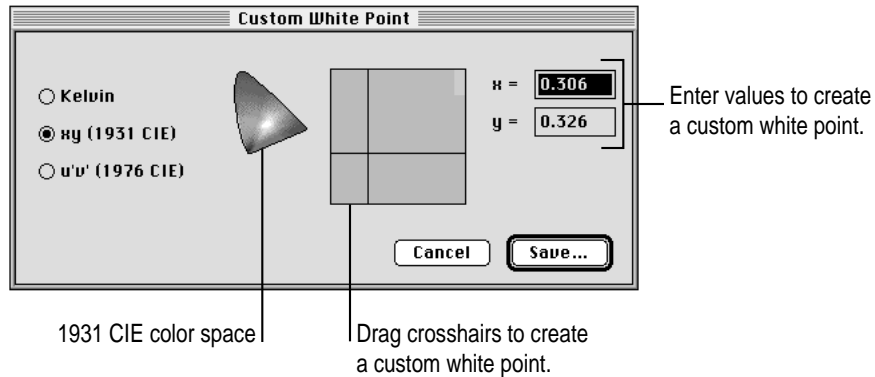

If you select the u'v' (1976 CIE) button, a representation of the 1976 CIE color space appears in the dialog box.

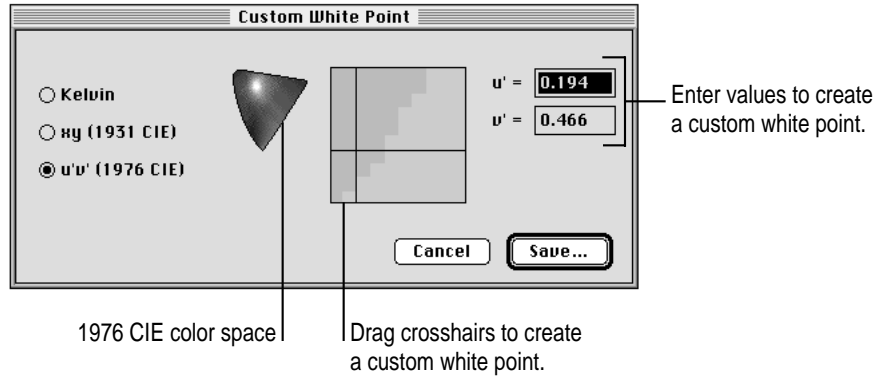

4 Drag the horizontal and vertical crosshairs to create the desired white point.

As you drag, the current coordinates appear to the right of the crosshairs.

In addition to dragging, you can enter specific xy or u'v' values to define a custom white point.

5 Click Save.

A dialog box appears.

6 Enter a name for your custom white point and click Save.

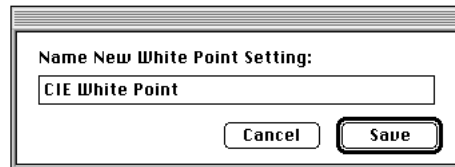

The custom white point is saved, and the name appears in the Custom White Point pop-up menu.

7 Click Recalibrate.

After several seconds, your display is recalibrated using the custom white point you created.

8 After you've created a custom white point, you can make another color adjustment or close the AppleVision Setup control panel.

After you create a custom a white point, it's a good idea to adjust for ambient light. See "Adjusting for Ambient Light," next.

Adjusting for ambient light

About ambient light

All light falling on the front of your display is called *ambient light* and can change how colors appear.

For example, in fluorescent light, the colors on your display may look redder than normal for the white point you defined. Near a window the colors may look more yellow.

To get a truer color rendering, set the white point for your display, and then correct for ambient light conditions in the room.

IMPORTANT To correct for ambient light, the color depth on your display must be set to Millions of Colors. To set color depth, see "Changing Color Depth" in Chapter 6. The number of colors you can set for your display may depend on the screen resolution you choose. If you can't set color depth to Millions of Colors, try changing to a lower screen resolution. For more information, see "Changing Screen Resolution" in Chapter 6.

Creating an ambient light setting

- 1 Locate the ambient light tool that came with your display.

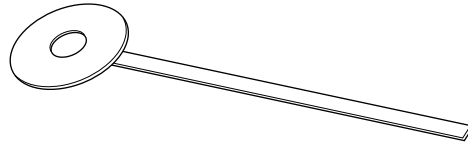

To create an ambient light setting, you match a color sample on your screen to the color of the light reflected from the tool. Make sure you use the gray side of the tool.

IMPORTANT Do not touch the gray, circular part of the ambient light tool. Store the tool in the envelope provided, away from direct sunlight. The gray color in the tool may fade and give you incorrect ambient light readings.

- 2 Open the AppleVision Setup control panel and click the Color button.

The Color window appears.

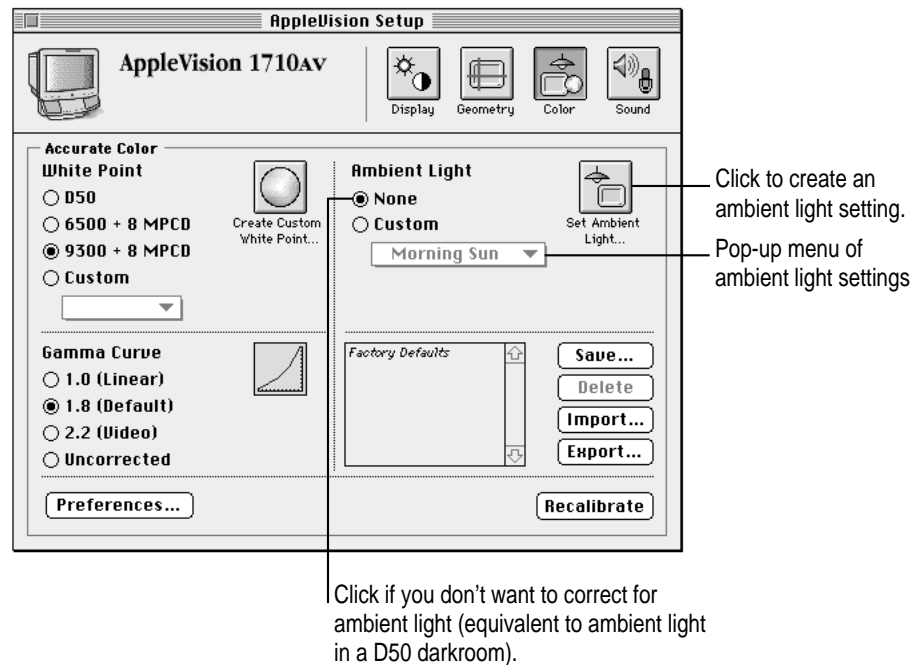

Click to create an ambient light setting.

Pop-up menu of ambient light settings

Click if you don't want to correct for ambient light (equivalent to ambient light in a D50 darkroom).

3 Click the Set Ambient Light button.

The Ambient Light window appears.

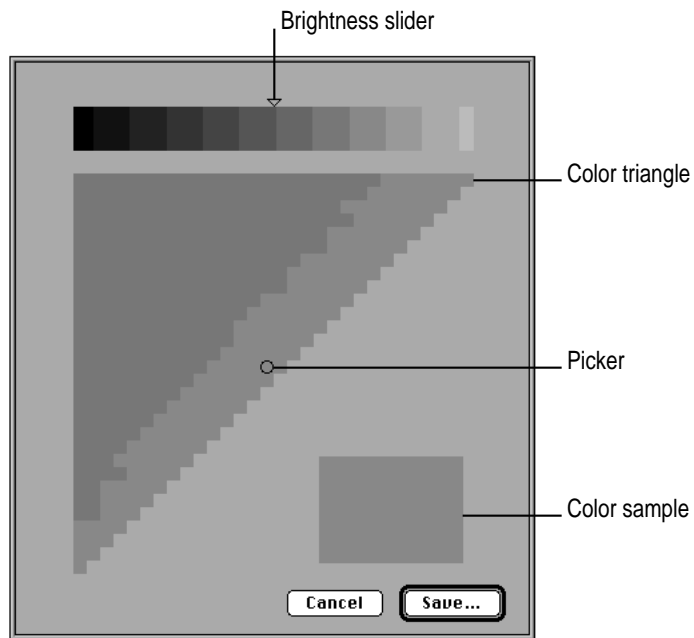

4 Hold the tool over the sample and look through the hole in the tool.

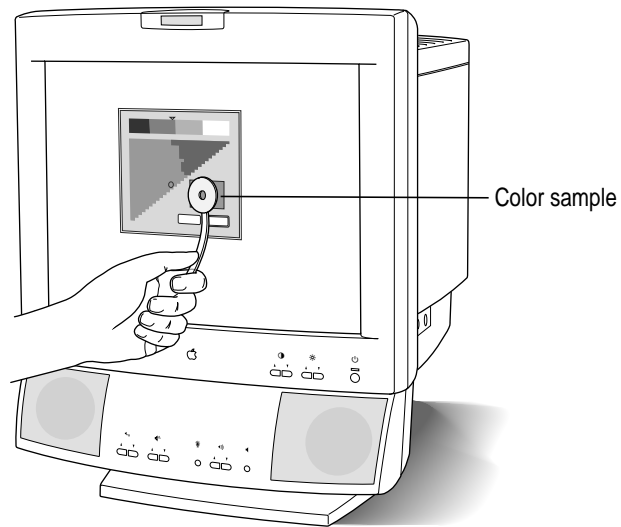

- 5 **Drag the picker in the color triangle until the color sample in the lower-right corner of the window is similar to the gray color on the tool.**

This gives you a general color adjustment.

- 6 **Drag the control on the Brightness slider until the color sample matches the tool exactly.**

When the tool and sample match, the hole in the tool seems to disappear.

- 7 **Click Save.**

A dialog box appears.

- 8 **Enter a name for your ambient light setting and click Save.**

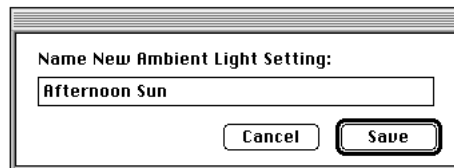

The ambient light setting is saved, and the name appears in the Custom Ambient Light pop-up menu.

- 9 **Click Recalibrate.**

After several seconds, your display is recalibrated to correct for ambient light.

- 10 **Close the AppleVision Setup control panel.**

Using an existing ambient light setting

You may want to create and use more than one ambient light setting for your display. For example, if your display is near a window, you may want one ambient light setting for the morning and another for the afternoon.

Note: Color adjustments may not work correctly if your display is in direct sunlight.

- 1 **Open the AppleVision Setup control panel and click the Color button.**

The Color window appears.

- 2 Choose an ambient light setting from the Custom Ambient Light pop-up menu.

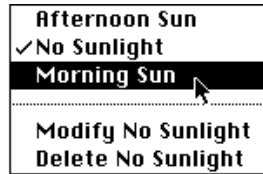

Note: If you haven't created an ambient light setting for your display, the Custom pop-up menu is dimmed. For information on creating an ambient light setting, see "Creating an Ambient Light Setting" earlier in this chapter.

- 3 Click Recalibrate.

After several seconds, your display is recalibrated using the ambient light setting you selected.

- 4 Close the AppleVision Setup control panel.

Deleting a custom white point or ambient light setting

Custom white points for your display appear in the Custom White Point pop-up menu. Ambient light settings appear in the Custom Ambient Light pop-up menu. To delete a setting from the pop-up menu:

- 1 Open the AppleVision Setup control panel and click the Color button.

The Color window appears.

- 2 Open the Custom White Point or Ambient Light pop-up menu and choose the setting you want to delete.

- 3 Close the menu.

The setting you selected is now the current setting in the pop-up menu and a checkmark appears next to the setting name.

4 Reopen the pop-up menu.

The Delete command at the end of the menu shows the name of the current setting.

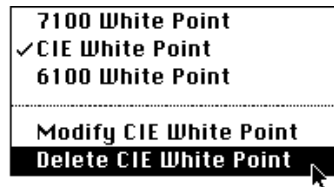

5 Choose Delete.

The setting is deleted.

6 Close the AppleVision Setup control panel.

Adjusting the gamma curve

You can adjust the gamma curve on your display to match images you acquire or images you are exporting, whichever is appropriate. For example, most scanners use a gamma value of 1.0, most computer displays (including the Macintosh) use a gamma value of 1.8, and video-editing equipment (such as HDTV) uses a gamma value of 2.2.

Use the Color window in the AppleVision Setup control panel to reset the gamma value.

1 Open the AppleVision Setup control panel and click the Color button.

The Color window appears.

2 Select a gamma value.

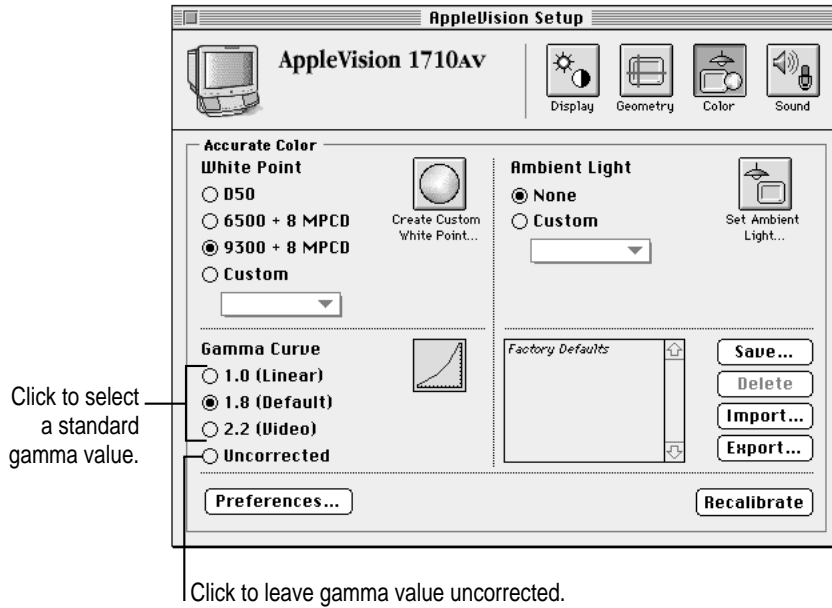

Typically, you select a gamma value that is compatible with the image you're displaying. Color images that have important details in highlights or shadows may need a different gamma value than standard images.

When you select a gamma value, the picture of the curve changes to show the new value.

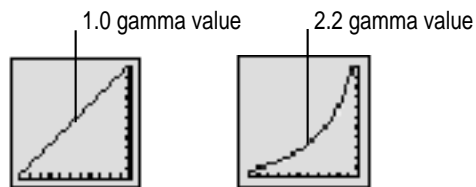

3 Click Recalibrate.

After several seconds, your display is recalibrated using the gamma value you specified.

4 After you've adjusted the gamma value, you can make another color adjustment or close the AppleVision Setup control panel.

Recalibrating your display

Whenever you change white point, ambient light, or gamma value, the changes don't take effect until you recalibrate your display. Also, when you make adjustments such as brightness, contrast, and screen geometry, it's a good idea to recalibrate to get maximum color accuracy.

To recalibrate your display:

- 1** Open the AppleVision Setup control panel and click the Color button.

The Color window appears.

- 2** Make sure the settings in the Color window are correct.

- 3** Click Recalibrate.

After several seconds, your display is recalibrated based on the settings shown in the Color window.

- 4** Close the AppleVision Setup control panel.

Recalibrating automatically

You can set preferences in the AppleVision Setup control panel so your display is recalibrated automatically every 2 weeks or when you change brightness, contrast, screen geometry, or screen resolution.

To set recalibration preferences:

- 1** Open the AppleVision Setup control panel and click the Color button.

The Color window appears.

2 Click Preferences.

A dialog box appears with a list of recalibration preferences.

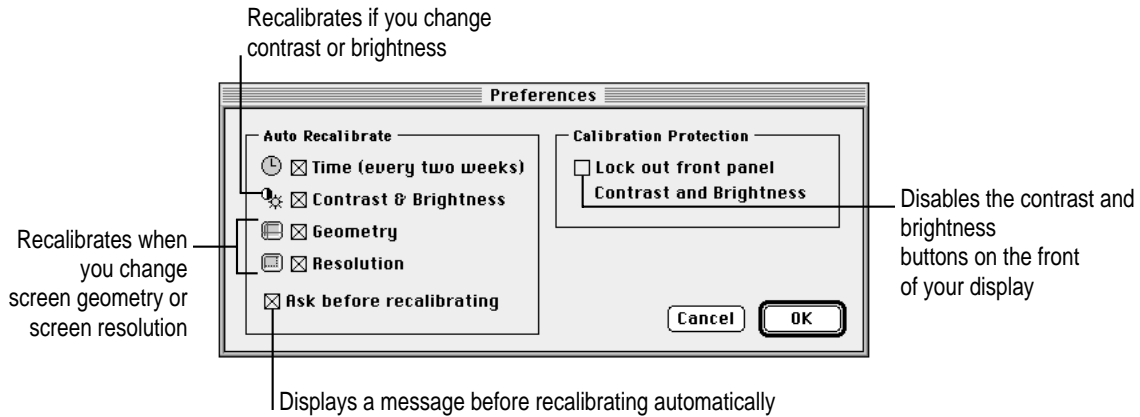

3 Select your recalibration preferences.

4 Click Save.

Your display will recalibrate automatically based on the preferences you selected.

5 Close the AppleVision Setup control panel.

Using color settings

You can save combinations of color settings and use them for different projects. For example, if you're editing a video tape, you might use a specific combination of white point, gamma value, and ambient light settings. If you're creating a printed product brochure, you might use a different combination.

Saving settings

1 Open the AppleVision Setup control panel and click the Color button.

The Color window appears.

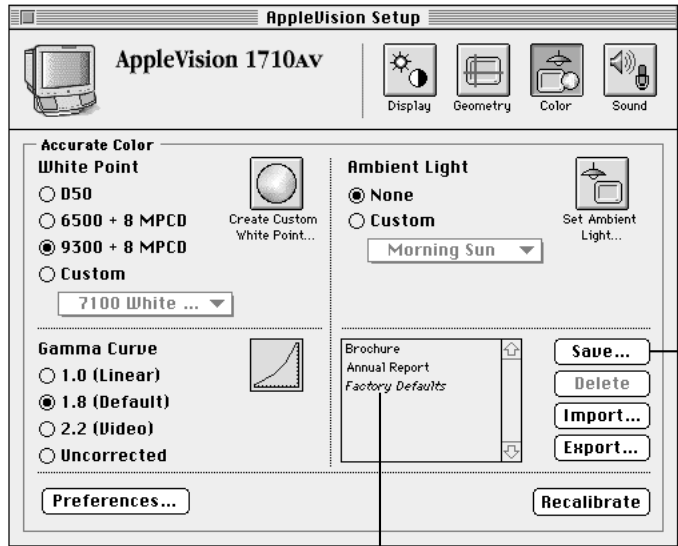

Double-click to use defaults shipped with your display (white point = 9300 + 8 MPCD, ambient light = none, gamma value = 1.8).

2 Make sure the color settings appear as desired.

For example, make sure the correct white point and ambient light setting are selected.

3 If desired, click Recalibrate to see how the settings change the screen image.

After several seconds, your display is recalibrated using the settings in the Color window.

4 Click Save.

A dialog box appears.

5 Enter a name for your settings.

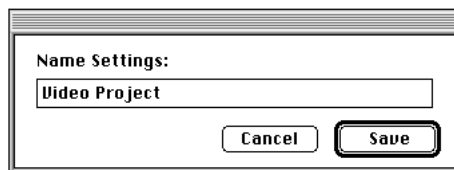

6 Click Save.

All settings in the Color window are saved and the setting name appears in the settings list.

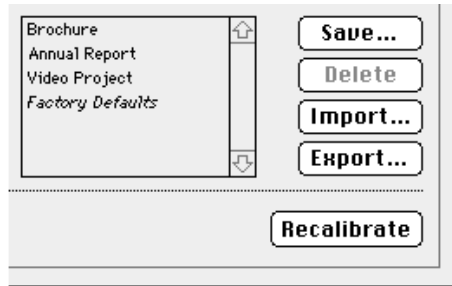

7 Close the AppleVision Setup control panel.

Using existing settings

To use settings you've already saved:

1 Open the AppleVision Setup control panel and click the Color button.

The Color window appears.

2 Click a name in the settings list.

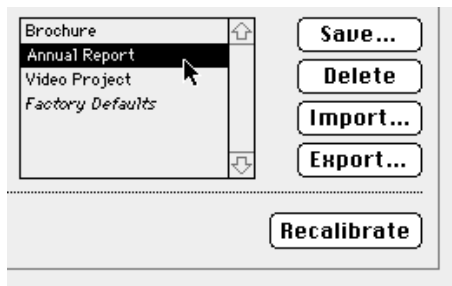

The Color window changes to show the settings associated with that name.

3 Click Recalibrate.

After several seconds, your display is recalibrated using the settings in the Color window.

Note: If you double-click a setting in the settings list, the setting is selected and the display recalibrates automatically.

- 4 Close the AppleVision Setup control panel.

Deleting a setting

To delete a setting you've saved:

- 1 Open the AppleVision Setup control panel and click the Color button.

The Color window appears.

- 2 Select the name of the setting you want to delete from the settings list.

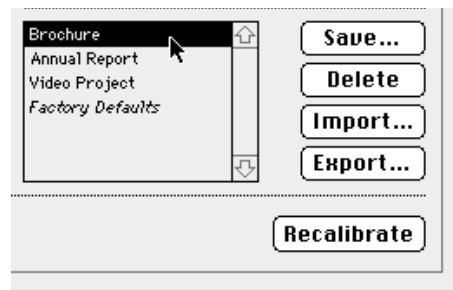

- 3 Click Delete.

The setting is deleted, and the name disappears from the list.

- 4 Close the AppleVision Setup control panel.

Importing and exporting ColorSync profiles

When you create custom color settings for your display, you can share those settings with other members of your workgroup to ensure consistent results.

The AppleVision 1710AV Display lets you create a ColorSync profile that describes the white point and gamma value for your display. You can use this profile with any display that supports Apple's ColorSync color-matching system. In addition, you can import a ColorSync profile from another display and use it with your AppleVision 1710AV Display. (For more information on ColorSync, see Appendix A.)

Exporting a ColorSync profile

- 1 Open the AppleVision Setup control panel and click the Color button.

The Color window appears.

- 2 Select the white point and gamma value you want to export.
- 3 If necessary, click Recalibrate.

Before you can export a ColorSync profile, your display must be recalibrated using the settings you want to export. If the Export button is dimmed, you need to recalibrate.

- 4 Click Export.

A Directory dialog box appears.

- 5 Enter a name for the profile and click Save.

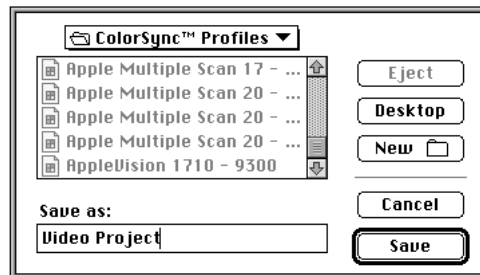

A ColorSync profile is created that describes the white point and gamma value for your display.

Note: The ambient light setting on your display is not saved as part of the ColorSync profile. Ambient light changes as the physical location of the display changes; the correct ambient light setting for your display will not be correct for another display.

- 6 Close the AppleVision Setup control panel.

For information on how to use the ColorSync profile you created, see Appendix A.

Importing a ColorSync profile

You can import a ColorSync profile created for another display and use it with your display.

- 1 **Open the AppleVision Setup control panel and click the Color button.**

The Color window appears.

- 2 **Click Import.**

A Directory dialog box appears.

- 3 **Select the profile you want to import and click Open.**

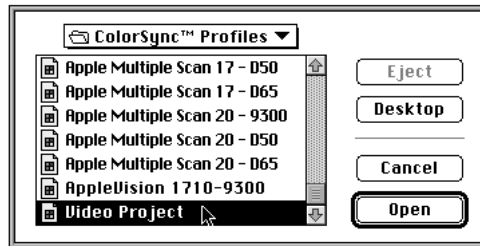

A ColorSync profile is imported to your display, and the settings in the Color window are updated.

- 4 **Click Recalibrate.**

After several seconds, your display is recalibrated using the settings you imported.

To get truer color rendering, you should adjust for ambient light after you import a ColorSync profile. See “Adjusting for Ambient Light” earlier in this chapter.

Bass, treble, and volume adjustments have an on-screen indicator that appears when you press a button on the front of the display. For example, pressing a Bass button displays the Bass indicator.

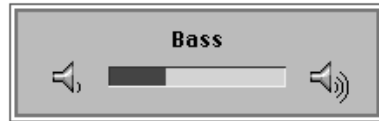

When you make an adjustment, the indicator bar moves to show the current setting. When you've finished making adjustments, the indicator disappears automatically.

About sound sources

Depending on the kind of Macintosh your AppleVision 1710AV Display is connected to, you may have several sound input sources:

- the AppleVision 1710AV Display
You can record from the built-in microphone or sound equipment attached to the display's sound input port (marked by ) on the left side of the display.
- an internal CD-ROM drive
- equipment attached to the back of your computer
This can be an external CD-ROM drive, cassette player, and so on.

Also, depending on the kind of Macintosh your AppleVision 1710AV Display is connected to, you may have several sound output devices:

- the AppleVision 1710AV Display
You can play sound on the built-in speakers or on sound equipment (such as headphones) attached to the display's sound output port (marked by )
- Equipment attached to the back of your computer
This can be headphones, speakers, and so on.

To play and record sound, select a sound input source and a sound output device. See the following sections for more information.

The Sound In window appears with a list of ports you can use for sound input. Depending on the equipment installed on your Macintosh, the Sound In window may look slightly different from the one shown below.

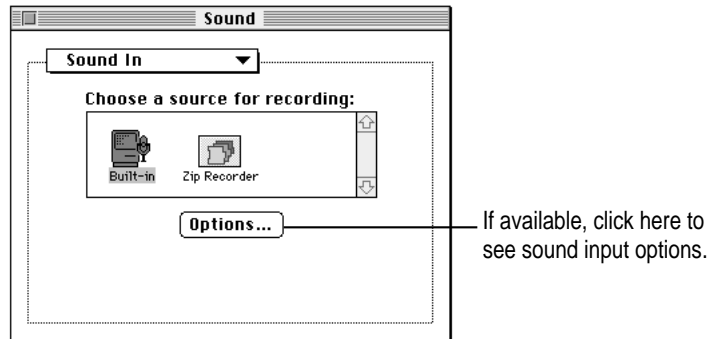

4 Select the Built-in icon.

The Built-in icon represents sound input ports that are a standard part of your Macintosh (for example, the sound input port on the back of the computer, an internal CD-ROM port, and so on).

Other icons represent additional sound input ports you may have installed on your computer. For example, you might have a video expansion card with sound input ports on the card.

You select the Built-in icon because the sound cable on the AppleVision 1710AV Display is connected to the sound input port on the back of your computer.

Note: If the AppleVision 1710AV Display is connected to an expansion card for a third-party product, see the manual that came with the product.

5 Click Options (if available) and select an input option.

On some Macintosh computers, Options is dimmed or doesn't appear when you select the Built-in icon. In this case, the correct option is automatically selected and you can skip to step 8.

A dialog box appears with a list of sound input options. The contents of this dialog box change depending on the type of Macintosh you're using.

- 7 Click OK.
- 8 Close the Sound control panel.

Selecting a sound input source for the display

After you select a sound input port on your computer, you select a sound input source for the display. This source can be the display's built-in microphone or equipment connected to the sound input port on the display.

- 1 Press a Control button on the front of your display (or open the AppleVision Setup control panel from the Apple [⌘] menu).

The AppleVision Setup control panel appears.

- 2 Click the Sound button in the AppleVision Setup control panel.



The Sound window of the AppleVision Setup control panel appears.

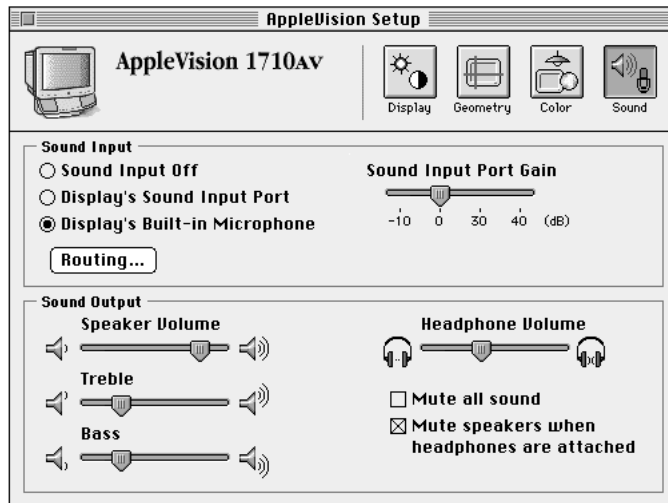

To select a sound output device:

- 1 **Choose Control Panels from the Apple (🍏) menu and open the Sound control panel.**

The Sound control panel appears.

IMPORTANT If the Sound control panel doesn't appear, you may have a different version of the AppleVision display software. In this case, instructions in this chapter don't apply. See Macintosh Guide for instructions on selecting a sound output device. To open Macintosh Guide, choose Macintosh Guide from the Guide menu (marked with the  icon).

- 2 **Choose Sound Out from the pop-up menu.**

The Sound Out window appears.

- 3 **Select the Built-in icon.**

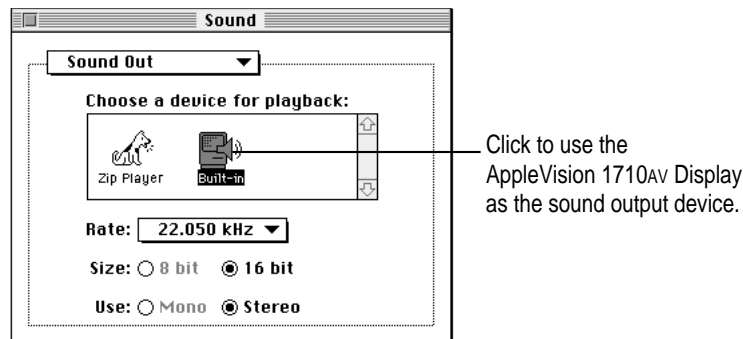

Depending on the type of Macintosh your display is connected to, your panel may look slightly different from the one shown.

You select the Built-in icon because the sound cable on the AppleVision 1710AV Display is connected to the sound output port on the back of your computer.

Note: If the AppleVision 1710AV Display is connected to an expansion card, select the icon that represents the expansion card. For expansion card support, you need Sound Manager 3.0 (available in System 7.5).

3 Select a routing path.

- *Loop Through Off:* Sound from sound input equipment attached to the display is routed to the computer. Use this setting when you're recording from an audio CD player (or other equipment) attached to your display and you don't want to hear the sound on your display.
- *Automatic:* Sound from sound input equipment attached to the display (for example, an audio CD or cassette player) is routed to the AppleVision 1710AV speakers and headphones and to the computer.

If Automatic is selected and a voice-quality microphone is attached to the sound input port on the display, sound is routed to the computer but not to the display's speakers and headphones.

A *voice-quality* microphone is any microphone that has an extended stereo miniplug connector. See "Connecting External Sound Equipment" in Chapter 1 for more information.

4 Click OK.

5 Close the AppleVision Setup control panel.

Adjusting volume

To adjust volume on the AppleVision 1710AV Display, make sure the volume controls in the Sound control panel are set properly. Then, use the AppleVision Setup control panel to adjust volume for your display.

Checking volume controls on your computer

When the AppleVision 1710AV Display is connected to your computer, the volume controls on the display interact with the volume controls on the computer. For example, if the main system volume on your computer is set too low, you will not hear sound on your display's speakers or headphones.

3 If available, choose Volumes from the pop-up menu.

The Volume panel on the Sound control panel appears.

Note: Some Macintosh computers don't have a Volume panel. If so, skip to step 5.

The contents of the Volume panel differ depending on the equipment you have installed on your Macintosh. Here are some examples:

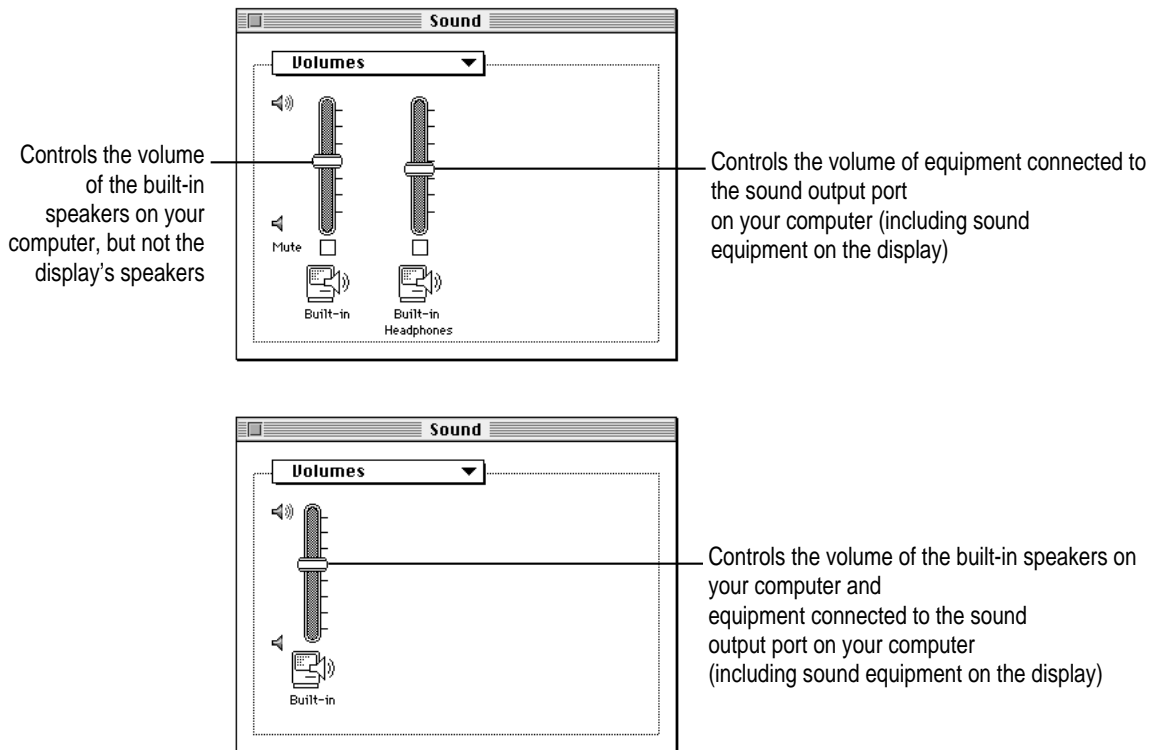

4 Make sure the volume controls are set correctly.

If the Volume panel has only one volume control, make sure it's set above minimum and Mute (if available) is not checked.

If the Volume panel has more than one volume control, make sure the volume control corresponding to the sound output port on your computer is set above minimum and Mute (if available) is not checked.

The Sound window of the AppleVision Setup control panel appears.

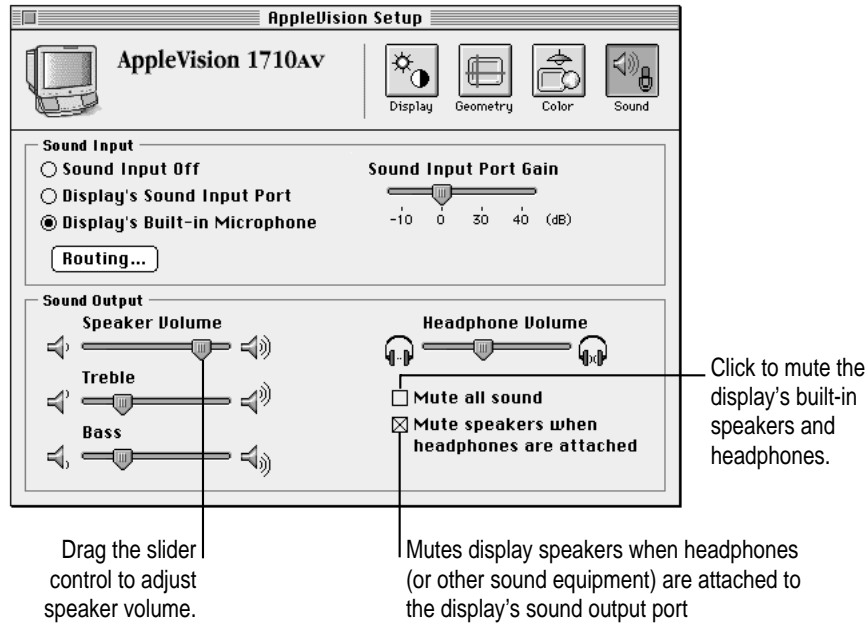

Note: If you have more than one display attached to your computer, the settings in the Sound window of the AppleVision Setup control panel apply only to the display listed near the top of the window. For more information, see “Using More Than One Display” in Chapter 3.

3 Use the Speaker Volume slider to adjust speaker volume.

Drag the slider control to the left to decrease volume. Drag the slider control to the right to increase volume.

4 If desired, adjust treble and bass.

Use the Treble slider to adjust treble and the Bass slider to adjust bass.

5 Adjust headphone volume.

The Headphone Volume slider controls the volume of any equipment connected to the sound output port (marked by ) on your AppleVision 1710AV Display.

IMPORTANT If the Sound control panel doesn't appear, you may have a different version of the AppleVision display software. In this case, instructions in this chapter don't apply. See Macintosh Guide for instructions on setting the alert sound. To open Macintosh Guide, choose Macintosh Guide from the Guide menu (marked with the  icon).

- 2** Click the alert sound that you want the computer to use.
- 3** Drag the slider control up or down to set the volume level.

Note: On some Macintosh computers, the volume control in the Alert Sounds panel must be set above minimum to hear sound on your AppleVision 1710AV Display. For more information, see “Checking Volume Controls on Your Computer” earlier in this chapter.

Installing an alert sound

Your computer comes with several alert sounds. You can get additional sounds from various sources.

To install a sound:

- 1** Drag the sound's icon to the System Folder icon (not the open System Folder window).
A message appears asking if you want to install the sound.
- 2** Click OK.

The sound is automatically installed in the System file.



Once you add a sound to the System file, it is listed in the Sound control panel.

- 5 **Get ready to record, then click Record.**

Recording begins immediately. The amount of time you have to record is displayed in the dialog box.

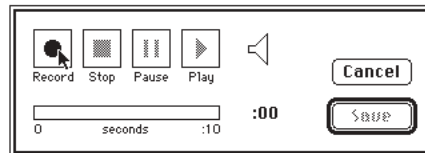

When the recorder is active, sound waves appear next to the speaker icon in the dialog box.

- 6 **Click Stop to stop recording.**
- 7 **To listen to the sound you recorded, click Play.**
- 8 **To save the sound you recorded, click Save.**
- 9 **Type a name for the sound, and click OK.**

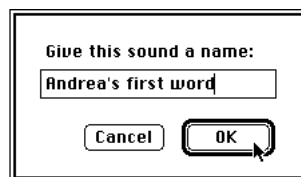

The new sound appears in the Sound control panel. Its icon also appears in the System file.

Recording a video with sound

The following sections describe how to use your AppleVision 1710AV Display to record a video with sound. To record a video with sound, you must have a Macintosh that supports video. For more information about connecting and using video equipment with your computer, see the manual that came with your computer.

The S-video connector is a round plug with several small metal pins. You can plug this type of connector into your computer's S-video input or output port.

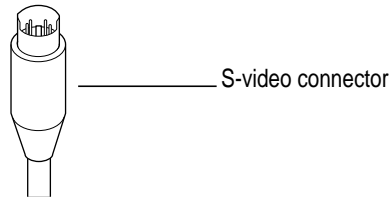

IMPORTANT The S-video connector resembles other Macintosh connectors, such as those for a printer, modem, mouse, or keyboard. Don't confuse the connectors; they are not interchangeable.

Many video devices use composite video format instead of S-video. The cables for these devices have RCA-type plugs.

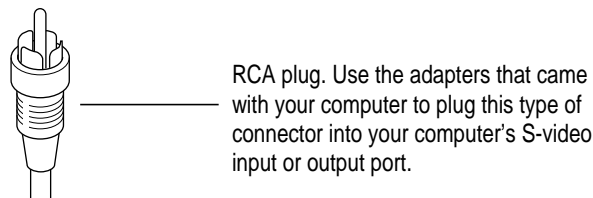

If your video equipment has an RCA-type plug and you don't have a composite video port on your Macintosh, you'll need an adapter to connect your video equipment to the S-video port on your Macintosh. This adapter converts an RCA plug into an S-video plug. The equipment shipped with your Macintosh may have included two of these adapters (one for video input, one for video output). If not, you can purchase one from an Apple-authorized dealer or electronics supply store.

Using video equipment with your AppleVision 1710av Display

The instructions that follow are for connecting a stereo VCR to a Macintosh with an S-video port, but you can use them as a model for connecting your computer to any video equipment.

- 5 **Plug the stereo miniplug on the audio cable into the sound input port (marked by ) on the left side of your AppleVision 1710AV Display.**

When you record a video with sound, you could connect all the video equipment to the back of your computer. However, you're already using the sound input port on the back of the computer for the sound cable on the AppleVision 1710AV Display. Therefore, you must plug the audio cable from the video equipment into the sound input port on your display.

Your finished video connections should look like this:

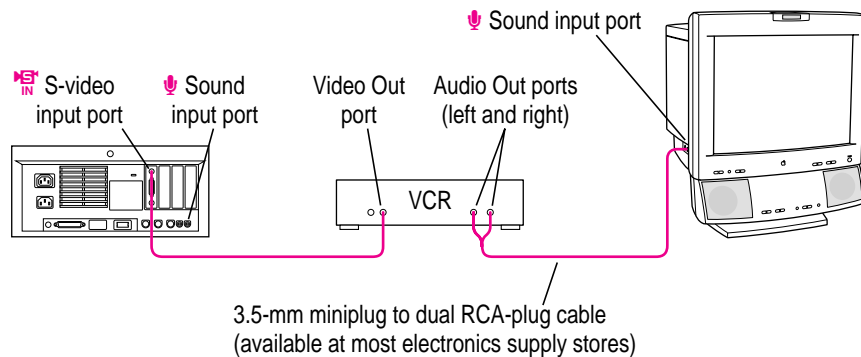

IMPORTANT In addition to the video connections shown above, the sound cable on your display should be connected to the sound input and sound output ports on the back of your computer.

- 6 **Turn on the computer, the AppleVision 1710AV Display, and the VCR.**

Recording a video

After the video equipment is connected to your computer and display, you can record the video.

- 1 **Open the Sound control panel and make sure the AppleVision 1710AV Display is selected as the sound input source on your computer.**

For more information, see “Selecting a Sound Input Port on Your Computer” earlier in this chapter.

- 2 **Close the Sound control panel.**

- 8 When you play the video, if the sound is harsh or garbled, adjust the gain and try recording again.

If the sound too loud, clipped, or has too much noise, try a lower gain setting. If the sound is too quiet, try a higher gain setting.

Playing an audio CD on AppleVision 1710AV speakers

You can connect an audio CD player to the AppleVision 1710AV display and play the sound on the AppleVision 1710AV speakers.

To play an audio CD:

- 1 Turn off the audio CD player and connect it to the sound input port (marked by ) on the left side of the display.

For more information, see “Connecting Sound Input Equipment to Your Display” in Chapter 1.

- 2 Close the Sound control panel.
- 3 Open the AppleVision Setup control panel and click the Sound button.

The Sound window in the AppleVision Setup control panel appears.

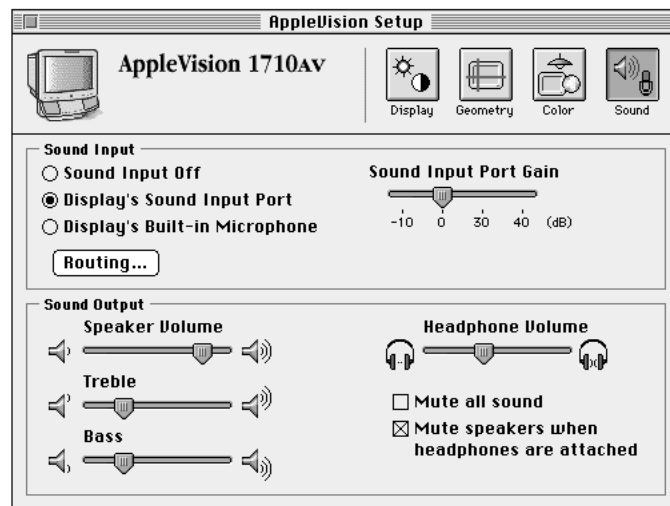

10 Adjust gain as desired.

Use the Display's Sound Input Port Gain slider in the AppleVision Setup control panel.

Note: When you attach sound equipment (such as an audio CD player) to the AppleVision 1710AV Display and use the AppleVision 1710AV speakers, gain settings of -10 or 30 produce low gain and gain settings of 0 or 40 produce high gain to the speakers.

11 Close the AppleVision Setup control panel.



6

The Control Strip



What is the Control Strip?

When you turn on your AppleVision 1710AV Display, a line of small pictures appears in the lower-left corner of the screen. This is called the *Control Strip*. Each picture in the Control Strip is called a *module*.

The Control Strip is a quick and easy way to make changes to common settings on your Macintosh such as screen resolution or color depth.

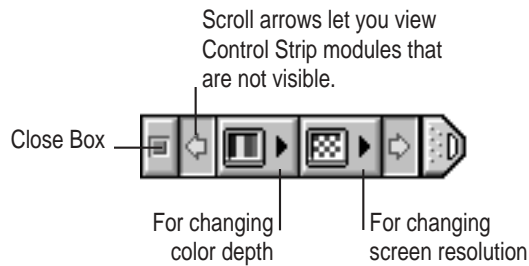

The Control Strip may look slightly different depending on the options on your Macintosh.

To get a description of each module in the Control Strip, pull down the Help menu, choose Show Balloons, and point to the modules one at a time.

How does the Control Strip differ from control panels?

Many features in the Control Strip work the same way as control panels. For the most part, however, control panels offer more options. The Control Strip gives you an easy way to access the features you use most often. You can still use the control panels anytime to fine-tune your settings.

Closing, opening, and resizing the Control Strip

Closing the Control Strip

The Control Strip appears on the desktop until you close it. You can close the Control Strip one of two ways:

 1 Click the tab at the end of the Control Strip.

 2 Click the close box at the beginning of the Control Strip.

The Control Strip appears on top of application programs. When you close the Control Strip, only the tab appears at the edge of the screen.

Opening the Control Strip

To open the Control Strip:

- Click once on the tab.



The Control Strip opens.

Resizing the Control Strip

You can shorten or lengthen the Control Strip to display fewer or more modules.

- Click and drag the tab.



The Control Strip shortens or lengthens as you drag the tab. If you shorten the Control Strip and can no longer see all the modules, use the scroll arrows.

Using the Control Strip

Changing screen resolution

You can change the resolution of your display to zoom in for detail work or zoom out to see a whole page at a time.

To change screen resolutions using the Control Strip:

- 1 Move the pointer over the screen resolution module in the Control Strip and hold down the mouse button.

A pop-up menu appears. If you have one display attached to your computer, the menu displays a simple list of screen resolutions. If your computer has more than one display attached, the menu changes to show a list of displays and resolutions for each display.

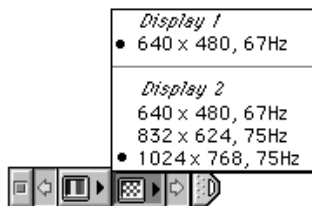

Note: The choices you see on the pop-up menu depend on what hardware you have.

2 Choose a screen resolution from the pop-up menu.

Depending on which option is set in the Monitors control panel, the new resolution appears as soon as you choose a resolution from the menu or when you restart your computer.

Changing color depth

You can change how many colors or shades of gray your AppleVision 1710AV Display can show.

To change color depth using the Control Strip:

1 Move the pointer over the color depth module in the Control Strip and hold down the mouse button.

A pop-up menu appears. If you have one display attached to your computer, the menu displays a simple list of color depths. If your computer has more than one display attached, the menu changes to show a list of displays and color depths for each display.

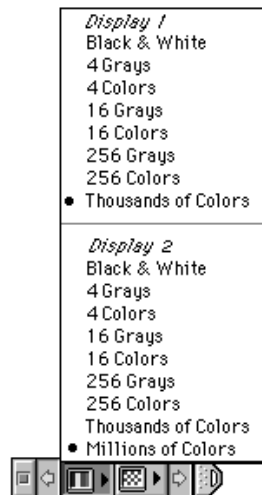

Note: The choices you see on the pop-up menu depend on what hardware you have and on the screen resolution you've chosen for your display.

- 2 Choose a color depth from the pop-up menu.**

Depending on which option is set in the Monitors control panel, the color depth changes as soon as you choose a color depth from the menu or when you restart your computer.

Moving and hiding the Control Strip

Moving the Control Strip

You can drag the Control Strip to the right or left edge of your screen. To reposition the Control Strip:

- 1 Hold down the Option key and drag the Control Strip by its tab.**

An outline of the Control Strip shows where the Control Strip will move to.

- 2 Release the Option key and mouse button.**

The Control Strip appears in its new position, and remains there until you move it again.

Hiding the Control Strip

If you want to hide the Control Strip so it does not appear at all on the desktop:

- 1 Choose Control Panels from the Apple () menu, and Open the Control Strip control panel.**



Control Strip

The Control Strip control panel appears.

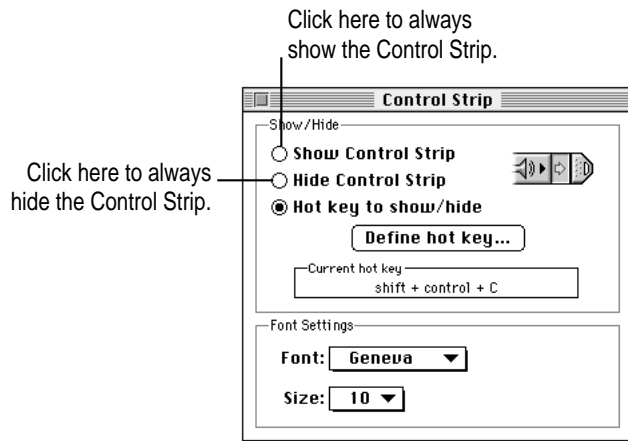

2 Click Hide Control Strip.

The Control Strip disappears from the screen.

To make the Control Strip reappear, select Show Control Strip. Or, you can use a hot key to show and hide the control strip. See “Defining a Hot Key for the Control Strip,” next.

Defining a hot key for the Control Strip

You can define a combination of keys, called a *hot key*, to show and hide the Control Strip.

To define a hot key for the Control Strip:

- 1 Choose Control Panels from the Apple () menu, and open the Control Strip control panel.

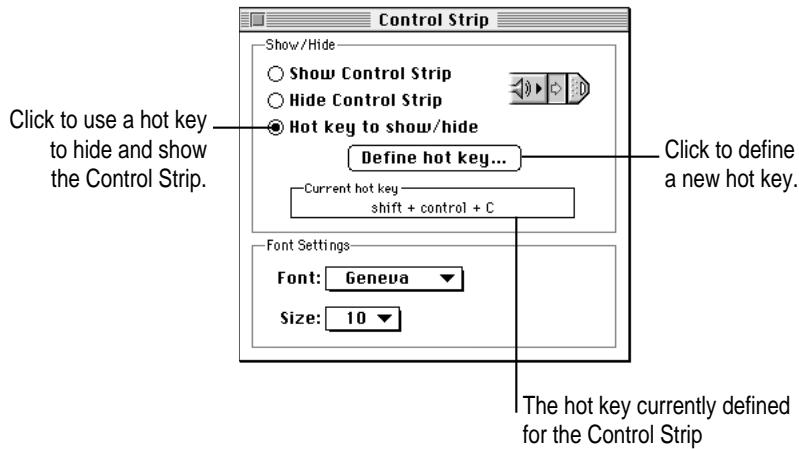

- 2 Click Define Hot Key.

The Hot Key dialog box appears.

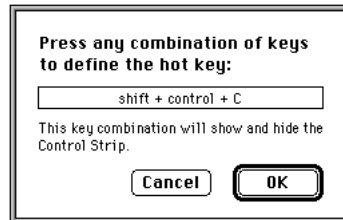

Press the key combination you want to use for the hot key. The key combination must include the Control, Option, or ⌘ key.

- 3 Click OK.

Your new key combination appears in the Control Strip control panel.

- 4 To make the hot key active, select “Hot key to show/hide.”

5 Close the Control Strip control panel.

The hot key you defined will show and hide the Control Strip. If the Control Strip is showing, pressing the hot key hides the Control Strip. If the Control Strip is hidden, pressing the hot key shows the Control Strip.

Customizing the Control Strip

Rearranging the modules in the Control Strip

You can customize the order of the modules in the Control Strip. To rearrange the modules:

- 1 Hold down the Option key and drag each module you want to move.**
- 2 Release the Option key and mouse button.**

The module you are moving snaps into place. The modules stay in the new order until you rearrange them.

Changing the menu font

By default, the pop-up menus in the Control Strip use a small typeface. You can change the font and font size for the menus.

- 1 Choose Control Panels from the Apple (🍏) menu, and open the Control Strip control panel.**

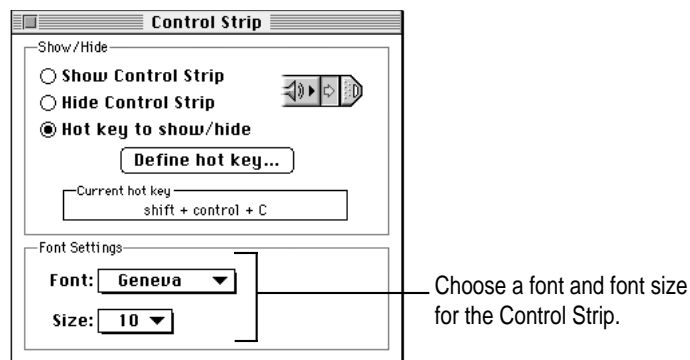

- 2** Choose a font from the Font pop-up menu.
- 3** Choose a font size from the Size pop-up menu.
- 4** Close the Control Strip control panel.

The Control Strip pop-up menus change to use the font and font size you selected.

7

Tips and Troubleshooting for Macintosh Users



This chapter includes information on the care and cleaning of your display, protecting your display from theft, and troubleshooting.

The AppleVision 1710AV Display works with both Macintosh and IBM PC-compatible computers. If you're using your display with an IBM PC-compatible computer, refer to Part II, "Using the Display With Your IBM PC-Compatible Computer."

Care and cleaning

- Do not block the display's vents.
- Do not let liquid get on or into the display.
- If you will not be using your display and computer for a long period of time (a day or more), make sure you turn off the computer (and your display, if necessary).

To clean the case and screen of the display:

- 1 Turn your computer and display off.**
- 2 Disconnect the display's power cord.**

If the display's power cord is connected to a wall outlet, disconnect the power plug from the outlet.

If the display's power cord is connected to the back of your computer, disconnect the display's power plug from the back of the display.

- 3 Wipe the case surfaces lightly with a clean, soft cloth dampened with water.**

Don't use aerosol sprays, solvents, or abrasives that might damage the finish on the case.

- 4 Use a mild, non-abrasive cleaner on a soft cloth and wipe the screen. Don't spray the cleaner onto the screen, because the liquid may drip inside the display.**

WARNING Do not use a cleaner that contains alcohol or acetone. You might damage the screen.

Protecting your display from theft

The slot at the base of the display in the back is for connecting a security lock. It lets you attach a narrow, flexible cable that you can use to secure your display (and the rest of your computer system) to prevent theft. Security locks are available from an Apple-authorized dealer or service provider.

Troubleshooting

Solutions to common problems related to your display are described here. Problems related to the computer itself are covered in the manuals that came with your computer.

WARNING Never remove the cover from the display or you may come in contact with hazardous voltage levels capable of causing serious injury and possibly death.

WARNING If you have a problem with your display and nothing presented in this manual solves it, consult the service and support information that came with your display for instructions on how to contact an Apple-authorized service provider or Apple for assistance. If you attempt to repair the display yourself, any damage you may cause to the display will not be covered by the limited warranty on your display. Contact an Apple-authorized dealer or service provider for additional information about this or any other warranty question.

The display's power indicator light doesn't come on.

- Make sure the computer is turned on.

The display's indicator light won't come on unless your computer is on.

- Make sure an energy saver program isn't active on the computer.

The display's indicator light won't come on when an energy saver program is on. Also, it may take awhile to wake up your computer after you use an energy saver.

- Make sure that the power cord is plugged in properly.

If the display power cord is plugged into your computer, make sure your computer is on and the cord is firmly plugged in.

If the display power cord is plugged into a wall outlet, make sure the cord is firmly plugged in. Check to see whether power to the outlet has been interrupted. You can test the outlet by plugging in something that you know works—like a desk lamp or radio. If the test appliance works, but the display doesn't, contact an Apple-authorized dealer or service provider.

- Make sure the display cable is plugged into your computer properly.

If you have a video card installed in your computer, the display cable should be plugged into the port for the video card.

If you do not have a video card installed in your computer, the display cable should be plugged into the display port on the back of your computer.

- Make sure the thumbscrews on the display cable are tightened securely.

No image appears on the screen and the display's power indicator light is on.

- Make sure the display cable is connected to the correct port on the back of the computer.

If you have a video card installed in your computer, the display cable should be plugged into the port for the video card.

If you do not have a video card installed in your computer, the display cable should be plugged into the display port on the back of your computer.

- Make sure the thumbscrews on the display cable are tightened securely.
- Make sure the contrast (●) and brightness (☼) controls are set correctly. The contrast and brightness controls are on the front of your display.

The screen is dark or appears dim.

- Make sure that your computer and display are turned on.
- Make sure that the power cord and the display cable are securely connected at both ends.
- Increase the contrast and brightness of the screen image. The contrast (●) and brightness (☼) controls are on the front of your display.
- A screen saver that darkens your screen may be activated. Move the mouse or press any key on the keyboard to reactivate the display.
- The Energy Saver option may be activated. Move the mouse or press any key on the keyboard to reactivate the display. In approximately 20 seconds (or until you no longer hear the beep), the display is reactivated.
- Some Macintosh computers may not wake up after Energy Saver is activated. Restart your computer and disable Energy Saver.

Contrast (●) and brightness (☼) controls on the front of the display don't appear to work.

- Your display may have the contrast (●) and brightness (☼) controls disabled. See “Recalibrating Automatically” in Chapter 4.
- Make sure you've installed the Macintosh software that came with your display. See “Installing the Macintosh Software” in Chapter 1.

The screen doesn't dim when Energy Saver is on.

- Make sure Energy Saver is set properly and the proper amount of time has passed for Energy Saver to work. See “Conserving Energy” in Chapter 2.
- Some Macintosh computers do not support Energy Saver. These include the Macintosh Quadra 660AV, the Macintosh Quadra 840AV, and other Macintosh computers.

The screen flickers.

- Make sure the display cable is connected firmly to the correct port on the back of the computer.

If you have a video card installed in your computer, the display cable should be plugged into the port for the video card.

If you do not have a video card installed in your computer, the display cable should be plugged into the display port on the back of your computer.

- The flickering could be caused by interference from a nearby power line or electrical equipment—for example, a radio, a microwave oven, or another computer. Try relocating nearby electrical equipment, or moving your computer and display.
- If you have more than one display attached to your computer, the displays might be interfering with one another. Move the displays farther apart or set the displays at an angle, so their screens are close and their back panels are farther apart. If after moving the displays more than 16 inches apart, you still see flickering, contact an Apple-authorized dealer or service provider.
- If you are using a video card that has a very low refresh rate (below 60 Hz), the display may flicker. You may be able to change the refresh rate for the card. See the manual that came with your video card for more information.

There are one or two very thin gray lines across the screen, one near the top and the other near the bottom.

- This is a normal characteristic of the Trinitron color picture tube design. The lines do not appear in any documents you print.

Over time, you experience eyestrain.

- Adjust the screen contrast. In a bright room, contrast is usually best set at maximum; in a dim room, lower contrast is usually more comfortable. The contrast (●) controls are on the front of your display. Also, be sure to take occasional breaks to focus your eyes on a distant object.
- Adjust the white point of the screen image. For most application programs, a white point of 9300 K is best. See “Setting a White Point” in Chapter 4.

The display doesn't appear in the Monitors control panel.

- After you install your AppleVision 1710AV Display, make sure the display power is on and restart your computer.
- Make sure you've installed the Macintosh software that came with your display. See “Installing the Macintosh Software” in Chapter 1.

A message appears, “This software only works with an AppleVision display.”

- After you install your AppleVision 1710AV Display, make sure the display power is on and restart your computer.
- Make sure you've plugged the display connector and ADB connector on the display cable into the correct ports. You may have plugged them into the wrong ports by mistake. See “Connecting the Display Cable” in Chapter 1.
- Make sure you've installed the Macintosh software that came with your display. See “Installing the Macintosh Software” in Chapter 1.

A message appears, “AppleVision Setup failed to load.”

- Make sure you've plugged the display connector and ADB connector on the display cable into the correct ports. You may have plugged them into the wrong ports by mistake. See “Connecting the Display Cable” in Chapter 1.
- Make sure your video card supports the AppleVision 1710AV Display. See the manual that came with your video card or computer.
- Make sure you're using System 7.1 or higher.

Changes in the AppleVision Setup control panel don't work for the display.

- Make sure you're using the correct AppleVision Setup control panel for the display. See "Using More Than One Display" in Chapter 3.

No colors appear on the screen.

- Check to make sure that the number of colors is set correctly in the Control Strip. See "Changing Color Depth" in Chapter 6.

The screen image is off center.

- Adjust the center of the image. See "Centering the Screen Image" in Chapter 3.

The screen image is too large or too small.

- Adjust the horizontal or vertical size of the screen image. See "Adjusting Height and Width" in Chapter 3.
- Make sure overscan is off. See "Turning Overscan On and Off" in Chapter 3.
- Try changing to another resolution. See "Changing Screen Resolution" in Chapter 2.

The screen image is tilted slightly to the left or right.

- Adjust the rotation of the screen image. See "Rotating the Screen Image" in Chapter 3.

Images or text on your screen appear fuzzy or blurred.

- Adjust the horizontal or vertical convergence of the screen image. See "Adjusting Convergence" in Chapter 3.

The colors on your screen appear too blue, too yellow, or too red.

- Adjust the color of the screen image. See Chapter 4, "Fine-Tuning Display Color."

The screen appears greenish, the screen image is blank or unreadable, or there is “snow” on the screen.

- Make sure the display cable is connected firmly to the correct port on the back of the computer.

If you have a video card installed in your computer, the display cable should be plugged into the port for the video card.

If you do not have a video card installed in your computer, the display cable should be plugged into the display port on the back of your computer.

There are wavy lines on the screen, creating an optical effect or moiré pattern.

- You may see a moiré pattern while in some resolutions, depending on the desktop pattern displayed on the screen (the black-and-white checkerboard pattern frequently causes moiré). To change to another resolution, see “Changing Screen Resolution” in Chapter 2. To change the desktop pattern, see the manuals that came with your computer or Macintosh Guide.

No colors appear when you set ambient light.

- Make sure the color depth on your display is set to Millions of Colors. See “Changing Color Depth” in Chapter 6.

ColorSync Profile files are not updated when the ColorSync application program is installed.

- Out-of-date profiles in the ColorSync Profiles folder are not removed automatically. If you want to remove a ColorSync profile, you must do so manually.

Not all displays attached to the computer appear in the Control Strip pop-up menus.

- Make sure the display is set up correctly and the display power is on. See “Connecting the Display to Your Macintosh Computer” in Chapter 1.
- If available, open the Monitors control panel and select the display that doesn’t appear on the Control Strip menus; then, close the control panel.

You hear no alert sound.

- Make sure the alert volume control in the Sound control panel is set correctly. See “Checking Volume Controls on Your Computer” in Chapter 5.

You don’t hear a system beep when you power-up your computer.

- There may be a delay between when the computer starts up and the speakers become active on your AppleVision 1710AV Display. This delay will not cause any problems.

You hear no sound on your AppleVision 1710AV speakers or headphones.

- Make sure the headphones are securely connected to the display’s sound output port (marked by .
- Make sure the volume in the AppleVision Setup control panel is set above minimum. See “Adjusting Volume, Treble, and Bass on Your Display” in Chapter 5.
- Make sure the volume controls in the Sound control panel are set correctly. See “Checking Volume Controls on Your Computer” in Chapter 5.
- If you have an audio CD player connected to the sound input port on your display, make sure the volume in the Audio CD control panel is set above minimum.
- If you have sound input equipment connected to your display, make sure the display is selected as the sound input source on your computer. See “Selecting a Sound Input Port on Your Computer” in Chapter 5.
- If headphones are connected, but you still want to play sound on your AppleVision 1710AV speakers, make sure “Mute speakers when headphones are connected” isn’t checked in the Sound window of the AppleVision Setup control panel.



Headphone volume is low.

- Make sure the Headphone Volume control in the Sound window of the AppleVision Setup control panel is set to maximum. See “Adjusting Volume, Treble, and Bass on Your Display” in Chapter 5.
- Make sure the volume controls on your computer are set correctly. See “Checking Volume Controls on Your Computer” in Chapter 5.

The internal microphone doesn't record.

- Turn on the microphone by pressing the microphone button (marked by ) on the front of your display. When the microphone is on, the microphone indicator light is on.
- Make sure the display's sound cable is connected properly. See “Connecting the Sound Cable” in Chapter 1.
- Make sure the display's microphone is selected as the sound input source in the AppleVision Setup control panel. See “Selecting a Sound Input Source” in Chapter 5.
- Sound input may be disabled. See “Adjusting Volume, Treble, and Bass on Your Display” in Chapter 5.

The microphone button on your keyboard doesn't turn on your display microphone.

- Some adjustable keyboards for the Macintosh have a button marked by . This button does not turn on the built-in microphone on your AppleVision 1710AV Display. Instead, use the microphone button (marked by ) on the front of the display.

You can still hear internal computer speakers when playing sound on the AppleVision 1710AV speakers.

- On some Macintosh computers, you must manually mute the internal computer speakers. See “Checking Volume Controls on Your Computer” in Chapter 5.

AppleVision 1710AV speakers don't mute when headphones are connected.

- Make sure “Mute speakers when headphones are connected” is selected in the Sound window of the AppleVision Setup control panel.

An external microphone connected to the sound input port (marked by ) on the display doesn't record quality sound.

- You may need to adjust the Gain for the microphone. See “Adjusting Volume, Treble, and Bass on Your Display” in Chapter 5.
- Some external microphones don't work well with the AppleVision 1710AV Display. Use the display's built-in microphone, or plug the external microphone directly into the sound input port on the back of your computer.

- If you're using the AppleVision 1710AV Display with another display that records sound, turn off the microphone on the other display. With both microphones on, you may get feedback or other interference.

Selecting Mute in an application program's window doesn't mute sound coming from the display.

- Some programs cannot mute sound coming from the AppleVision 1710AV Display. To mute the sound, select "Mute all sound" in the Sound Window of the AppleVision Setup control panel.

Using the Display With Your IBM PC-Compatible Computer

Chapter 8 **Setting Up for IBM PC-Compatible Users**

Chapter 9 **Adjusting the Screen Image**

Chapter 10 **Tips and Troubleshooting for IBM PC-Compatible Users**

Part II of this book describes how to use the display with your IBM PC-compatible computer. To use the display with your Macintosh computer, see Part I.



II
part

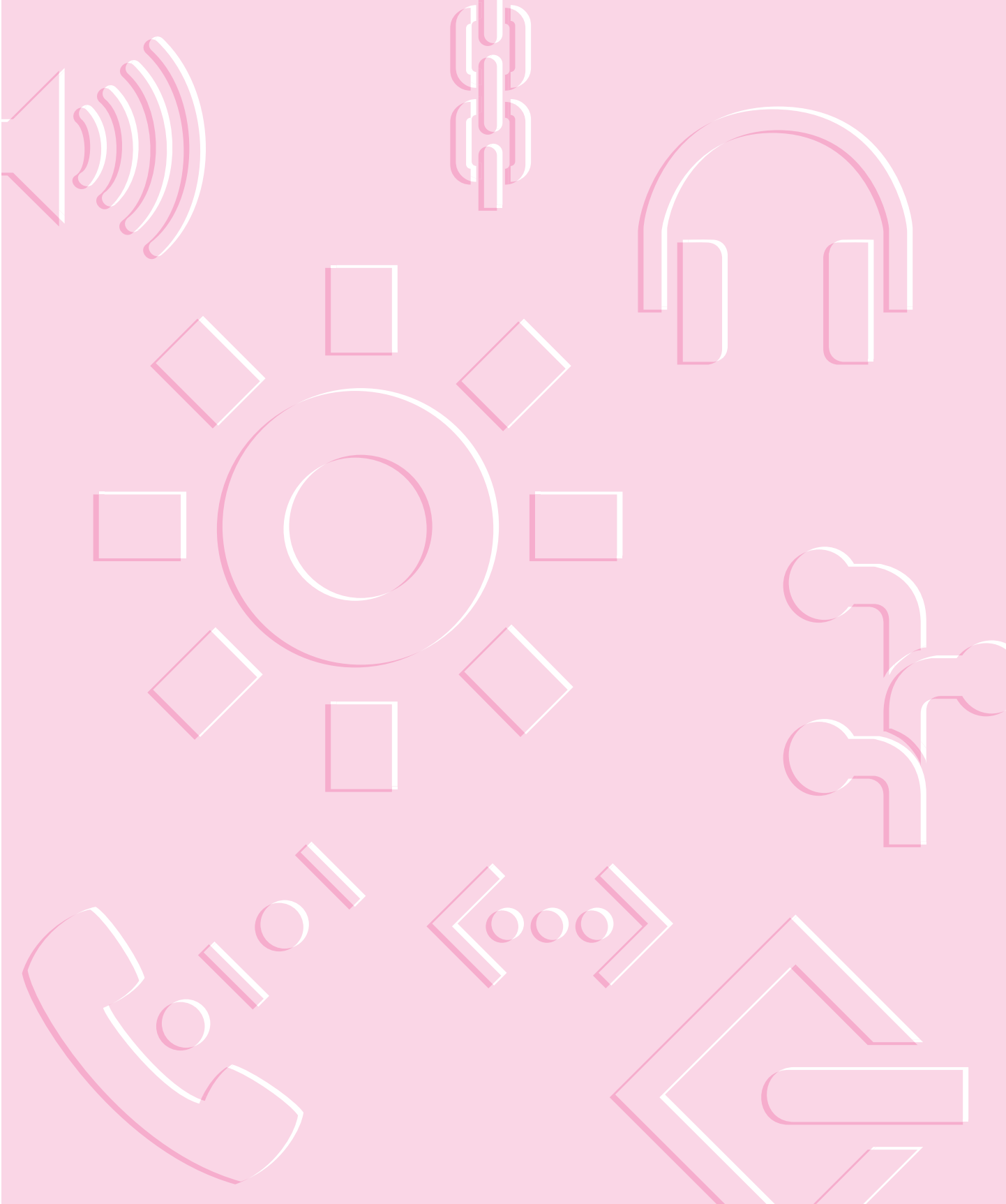

8

Setting Up for IBM PC-Compatible Users

This chapter describes how to use your AppleVision 1710AV Display with an IBM PC-compatible computer.

The AppleVision 1710AV Display works with both Macintosh and IBM PC-compatible computers. If you're using your display with a Macintosh computer, refer to Part I, "Using the Display With Your Macintosh Computer."

Important safety and cleaning instructions

WARNING Do not clean your display screen with a cleaner that contains alcohol or acetone. You might damage the screen. For more information about cleaning your display, see "Care and Cleaning" in Chapter 10.

For your own safety and that of your equipment, always take the following precautions.

Disconnect the power plug (by pulling the plug, not the cord) if any of the following conditions exists:

- the power cord or plug becomes frayed or otherwise damaged
- you spill something into the case
- your display is exposed to rain or any other excess moisture
- your display has been dropped or the case has been otherwise damaged

- you suspect that your display needs service or repair
- you want to clean the case (use only the recommended procedure described in “Care and Cleaning” in Chapter 10)

IMPORTANT The only way to disconnect power completely is to unplug the power cord. Make sure at least one end of the power cord is within easy reach so that you can unplug the display when you need to.

Be sure that you always:

- Keep your display away from sources of liquids, such as wash basins, bathtubs, shower stalls, beverages, and so on.
- Don't set anything on top of the display (such as a book or cup).
- Keep the display's vents free from obstruction.
- Protect your display from dampness or wet weather, such as rain, snow, and so on.
- Read all the installation instructions carefully before you plug your display into a power source.
- Keep these instructions handy for reference by you and others.
- Follow all instructions and warnings dealing with your system.

WARNING Never remove the cover from the display or you may come in contact with hazardous voltage levels capable of causing serious injury and possibly death.

WARNING Electrical equipment may be hazardous if misused. Operation of this product, or similar products, must always be supervised by an adult. Do not allow children access to the interior of any electrical product and do not permit them to handle any cables.

Compatibility

This display works with most IBM PC-compatible computers equipped with VGA (Video Graphics Array) or greater capability. You may need to install a video card to use the display with your computer. For more information, see the manuals that came with your computer.

The display is preadjusted and works with any computer that has the following timing ranges:

- horizontal scan rate of 30-80 kilohertz
- vertical refresh rate of 50-120 hertz

In addition, this display also works at the following VESA (Video Electronics Standards Association) standard modes:

Resolution	Vertical refresh rate (hertz)
640 x 480	60 (VGA)
800 x 600	60-75 (SVGA)
1024 x 768	60 (XGA)
1280 x 1024	60-75

These are preassigned resolutions; your computer may support other resolutions within this range. See the manual that came with your computer or video card to determine which resolutions are supported.

If you don't use a preassigned resolution, you'll need to adjust screen geometry to match the new resolution. For more information, see "Adjusting Screen Geometry" in Chapter 9.

Getting ready to set up

Before you set up your display, make sure you have easy access to the following items that came with your AppleVision 1710AV Display:

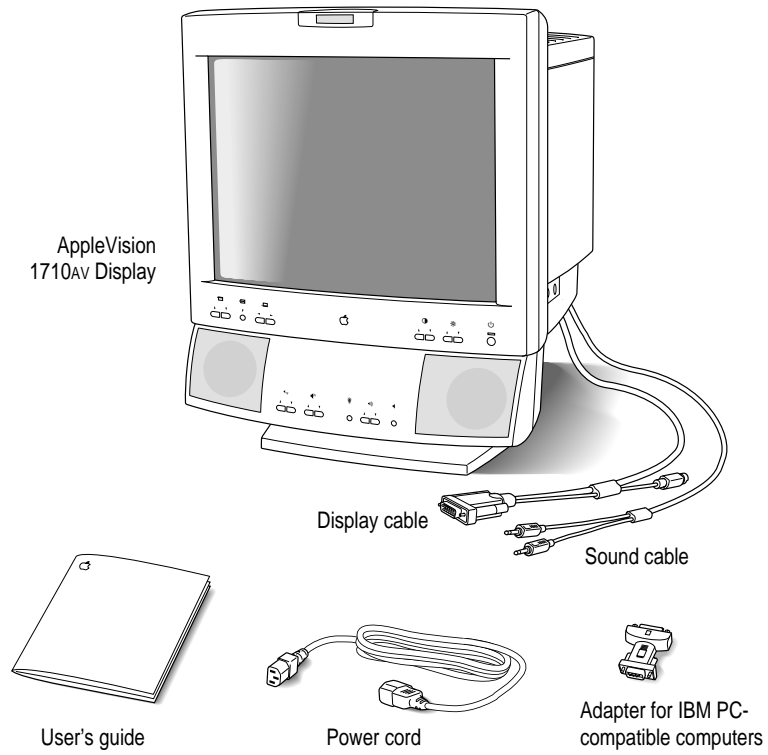

Choosing a good location for your display

Here are some key factors to consider when determining where to place your display:

- Be sure that the desk or table can support the display's weight—approximately 60 pounds (27 kilograms).
- Make sure that the power cord and display cable will reach from the back of the display to your computer.
- The display cable should be unobstructed when you swivel and tilt the display, so allow at least 7 inches (17.5 cm) of clearance in the back. If you don't allow enough clearance, the display connector might be damaged when the cable hits an obstruction.

Positioning the display

IMPORTANT When you unpack or move the display, don't set the display down at an angle; you might damage the display stand.

Once your display is in place on a desk or table, follow these steps:

- 1 Place the display so that the screen faces the user.**
- 2 To slide the display, lift the front up slightly and push or pull in the direction you want.**
- 3 Adjust the viewing angle of the display by tilting it up or down and turning it left or right on its stand.**

Position the display so that when you use it, no bright light is behind the display or reflected on the screen. Your eyes should be about level with the top edge of the screen and between 18 and 28 inches (45 to 70 cm) away. Take occasional breaks when using your computer to focus your eyes on a distant object.

For your greatest comfort, use the following illustration to help you position your display.

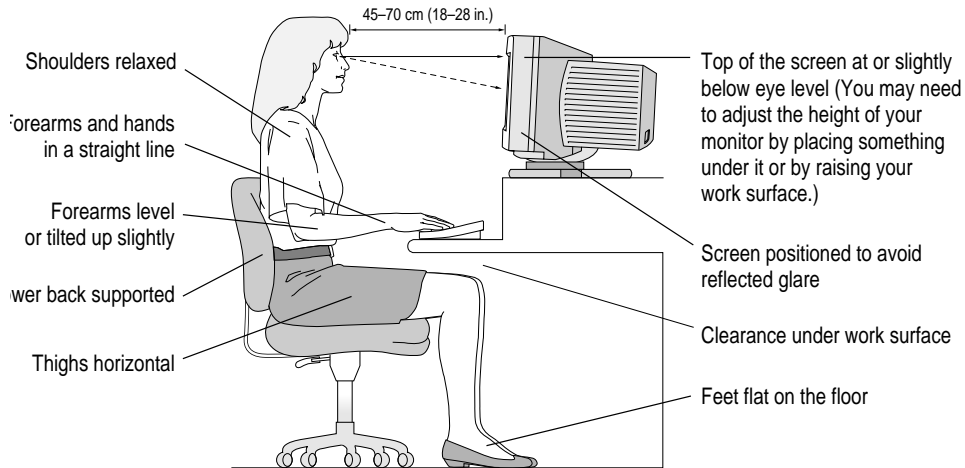

Connecting the display to your IBM PC-compatible computer

Use these instructions to connect the display to your computer.

Note: If you need to use a video card with your computer, install the card before you connect the display to your computer.

IMPORTANT Before you connect any cords or cables, make sure that your computer is turned off and unplugged.

WARNING This equipment is intended to be electrically grounded. Your display may be equipped with a three-wire grounding plug—a plug that has a third (grounding) pin. This plug will fit only a grounded AC outlet. This is a safety feature. If you are unable to insert the plug into the outlet, contact a licensed electrician to replace the outlet with a properly grounded outlet. Do not defeat the purpose of the grounding plug!

Connecting the power cord

- 1 Connect the socket end of the power cord to the power cord receptacle on the back of the display.

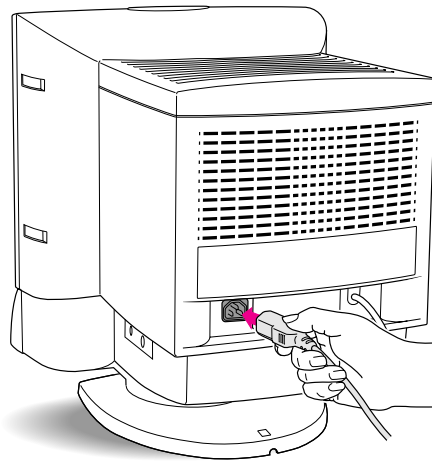

- 2 Plug the other end of the power cord into a grounded outlet or power strip.

Connecting the display cable

The display cable on your AppleVision1710av Display is a split cable with two connectors, one for the display and one for the Apple Desktop Bus (ADB).

- 1 Connect the PC adapter to the display connector (marked by I O I) on the display cable.

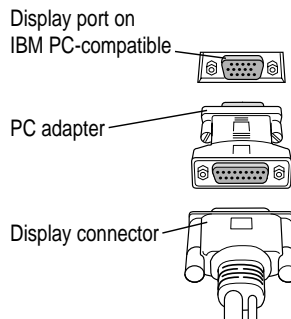

2 Tighten the thumbscrews on the connection.

You can prevent bad connections and accidental damage by tightening the thumbscrews. Do not overtighten the thumbscrews, you might strip the threads.

3 Connect the PC adapter end of the display cable to the display port on the back of your computer.

If you installed a video card in your computer, connect the display cable (with the PC adapter attached to it) to the video card's port. For more information about installing video cards, see the manual that came with your computer or video card.

4 Tighten the thumbscrews on the connection.

5 Leave the ADB connector on the display cable unplugged.

The ADB connector is for Macintosh computers only. You don't use it with an IBM PC-compatible computer. Use the clip on the display cable to move the connector out of the way.

Connecting the sound cable

The sound cable on your AppleVision 1710AV Display display is a split cable with two connectors, one for sound input (such as a microphone or audio CD) and one for sound output (such as a speaker).

Connect this cable to your computer if you want to use the built-in microphone and speakers on your AppleVision 1710AV Display.

1 Plug the connector (marked by ) on the sound cable into the sound input port on your computer.

The connector (marked by ) fits most standard microphone jacks. The sound input port on your computer may be located on a sound or multimedia card.

On some IBM PC-compatible computers, the connector (marked by ) on the sound cable plugs into the line level input port.



- 2 **Plug the connector (marked by ) on the sound cable into the sound output port on your computer.**

The connector (marked by ) fits most standard speaker jacks. The sound input port on your computer may be located on a sound or multimedia card.

Connecting sound input equipment to your display

To record sounds, you can use the built-in microphone on your AppleVision 1710AV Display, or you can connect external sound input equipment (such as an audio CD player, cassette player, or external microphone) to the display.



To connect sound input equipment:

- 1 **Make sure the connector (marked by ) on the sound cable is plugged into the sound input port on your computer.**
- 2 **Plug the equipment into the sound input port (marked by ) on the left side of the display.**

Note: To use sound input equipment (such as an audio CD player, cassette player, or external microphone) you must select the correct sound input source on your computer. See the manual that came with your computer.

Connecting sound output equipment to your display

If you wish, you can plug a pair of headphones (or other sound output equipment) into the AppleVision 1710AV Display. To plug your headphones into the display, follow these steps:

- 1 **Make sure the connector (marked by ) on the sound cable is plugged into the sound output port on your computer.**
- 2 **Plug the headphones into the sound output port (marked by ) on the right side of the display.**

WARNING Be careful not to plug your headphones into the sound input port (marked by ). Doing so may damage your audio equipment.

- 3 **Before using the headphones, check the volume to make sure it's not too loud.**

Turning the display on

To turn on the display for the first time:

- 1 Press the power button on the front right side of the display.**

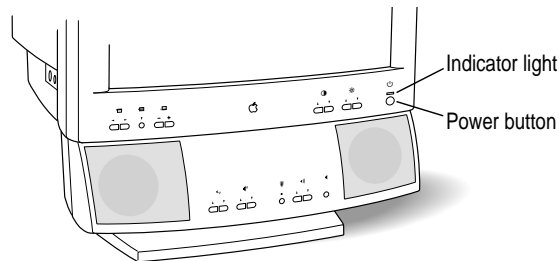

Note: The display's power indication light doesn't go on until you start your computer.

- 2 Start up your computer.**

The power indicator light goes on. If the power indicator light does not go on, press the power button again. If this doesn't work, make sure you've connected the display to your computer properly (see "Connecting the Display to Your IBM PC-Compatible Computer" earlier in this chapter). Also, make sure your computer is turned on.

Using the display

To change resolutions on your display, see the manuals that came with your operating software or video card.

In most cases, once you turn on the display, you will not have to make any adjustments to the screen image. If necessary, you can adjust or fine-tune the image to suit your personal preference. For more information, see Chapter 9.

Note: The files on the *AppleVision Software* disk are useful only for Macintosh computers.

9

Adjusting the Screen Image



This chapter describes how to adjust the screen image on your AppleVision 1710AV Display. In most cases, you won't need to adjust the image unless you make changes to screen resolution.

Note: The instructions in this chapter apply only if you're using the AppleVision 1710AV Display with an IBM PC-compatible computer. If you're using the display with a Macintosh computer, refer to Part I, "Using the Display With Your Macintosh Computer."

Controls at a glance

The buttons on the front of your display provide a quick way to adjust the screen image and sound.

Use the following buttons to make screen image adjustments:

Control buttons

Use these buttons to make screen image adjustments. See “Using On-Screen Controls” later in this chapter.

Contrast controls

Press ▲ to increase contrast, press ▼ to decrease contrast.

Brightness controls

Press ▲ to increase brightness, press ▼ to decrease brightness.

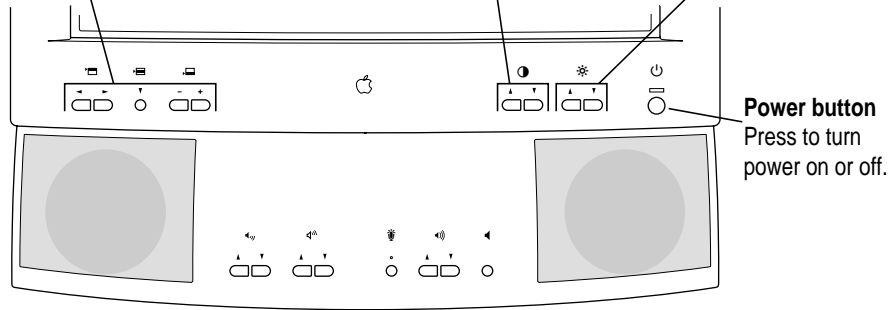

Use the following buttons to make sound adjustments:

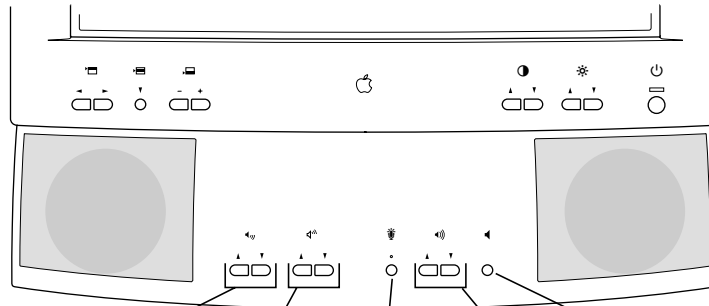

Bass controls

Press ▲ to increase bass, press ▼ to decrease bass.

Microphone button

Press to turn the display's built-in microphone on or off.

Mute button

Press to turn mute on or off.

Treble controls

Press ▲ to increase treble, press ▼ to decrease treble.

Volume controls

Press ▲ to increase volume, press ▼ to decrease volume.

Using on-screen controls

Your AppleVision 1710AV Display comes with a set of on-screen controls you use to adjust the screen image.

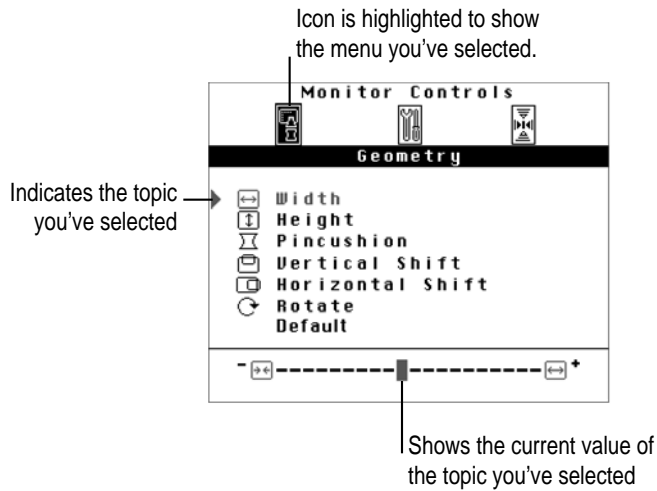

Use the Control buttons on the front of your display to open the on-screen controls and select topics from the menus.

Click any button to open the on-screen controls.

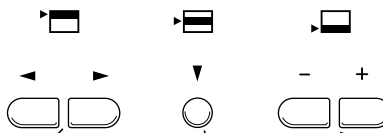

Press ◀ or ▶ to select a menu. Icons on-screen are highlighted to show the menu you've selected.

Press ▼ to select a topic on a menu. An arrow appears next to the topic you've selected.

Sets a value for the selected topic. Press the – button to decrease the value. Press the + button to increase the value.

Adjusting screen geometry

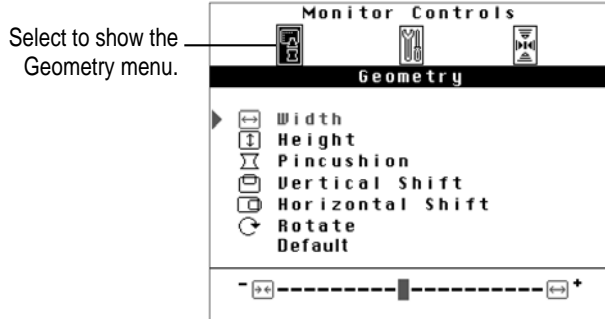

Use the Geometry menu to adjust height and width of the screen image, center the image on the screen, and so on.

Width

Adjusts the width of the screen image. Press the - button to decrease width. Press the + button increase width. When the width and height of the screen image are set properly, you can see the entire image on the screen.

Height

Adjusts the height of the screen image. Press the - button to decrease height. Press the + button to increase height. When the height and width of the screen image are set properly, you can see the entire image on the screen.

Pincushion

Adjusts the shape of the screen image. Press the - button to bring in the sides of the image, changing the shape from convex to concave. Press the + button to expand the sides of the image, changing the shape from concave to convex. When the shape of the image is set properly, the left and right sides are straight and the image is rectangular.

Vertical Shift

Adjusts the vertical position of the screen image. Press the - button to move the image down. Press the + button to move the image up. When the screen image is centered properly, there is an equal border around all edges of the image.

Horizontal Shift

Adjusts the horizontal position of the screen image. Press the - button to move the image to the left. Press + to move the image to the right. When the screen image is centered properly, there is an equal border around all edges of the image.

Rotate

Rotates the screen image. Press the - button to rotate counterclockwise. Press the + button to rotate clockwise. When the rotation of the screen image is set properly, all four sides of the image are parallel to the edges of the screen and the image is rectangular.

Default

Returns screen adjustments to the preset factory values. Press either the - or + button to turn defaults on.

Adjusting color temperature and overscan

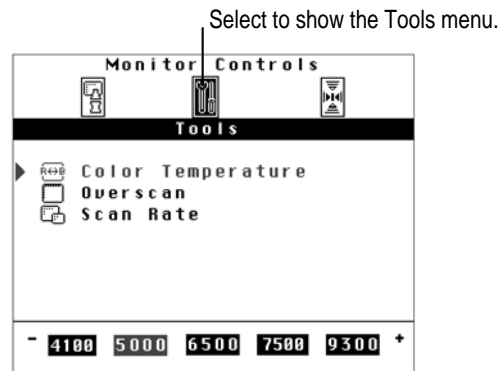

Use the Tools menu to set color temperature or turn overscan on and off. You can also use the Tools menu to show the scan rate of your display.

Color Temperature

Adjusts the color temperature of your display. The *color temperature* (or *white point*) you select for your display sets the mix of red, green, and blue lights that make the color white. This color temperature sets the foundation for other colors on your display.

The color temperature of your display can be changed to one of the following Kelvin temperatures: 4100 K, 5000 K, 6500 K, 7500 K, or 9300 K. *Kelvin* is a temperature scale used in scientific applications.

Press the - button to decrease color temperature. Press the + button to increase color temperature. Changing the color temperature changes the appearance of colors on the screen. Lower temperature settings create reddish whites, and higher temperature settings create bluer whites.

Overscan

Turns overscan on and off. Overscan moves the screen image as far to the edges of the screen as possible without distorting the image. If overscan is on, pressing the - or + button turns overscan off. If overscan is off, pressing the - or + button turns overscan on.

When overscan is on, you cannot make screen geometry adjustments such as horizontal shift, rotation, and so on.

Scan Rate

Shows the scan rate of your AppleVision 1710AV Display. This setting is for informational purposes only; it's not for adjusting the scan rate.

Adjusting convergence

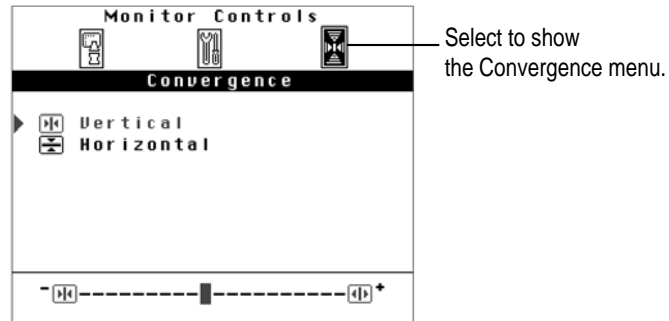

Red, green, and blue signals in your display converge to create the colors you see on your screen. If the convergence is not set properly, images or text on your screen may appear blurred, or you may get a “rainbow” effect with several colors forming the edges of images on the screen.

If your display is exposed to an external electromagnetic field (for example, from another display or unshielded speakers) over a period of time, you may need to change the convergence to get a clear, distinct screen image.

Use the Convergence menu to adjust screen convergence. When convergence is set properly, the image is clear and distinct.

Vertical

Adjusts the vertical convergence. Press the - button to move the red signal down and the blue signal up. Press the + button to move the red signal up and the blue signal down.

Horizontal

Adjusts the horizontal convergence. Press the - button to move the red signal to the left and the blue signal to the right. Press the + button to move the red signal to the right and the blue signal to the left.

10

Tips and Troubleshooting for IBM PC-Compatible Users



This chapter includes information on the care and cleaning of your display, protecting your display from theft, and troubleshooting.

The AppleVision 1710AV Display works with both Macintosh and IBM PC-compatible computers. If you're using your display with a Macintosh computer, refer to Part I, "Using the Display With Your Macintosh Computer."

Care and cleaning

- Do not block the display's vents.
- Do not let liquid get on or into the display.
- If you will not be using your display and computer for a long period of time (a day or more), make sure you turn off the computer (and your display, if necessary).

To clean the case and screen of the display:

- 1 Turn your computer and display off.**
- 2 Disconnect the display's power cord from the grounded wall outlet.**
- 3 Wipe the case surfaces lightly with a clean, soft cloth dampened with water.**

Don't use aerosol sprays, solvents, or abrasives that might damage the finish on the case.

- 4 Use a mild, non-abrasive cleaner on a soft cloth and wipe the screen. Don't spray the cleaner onto the screen, because the liquid may drip inside the display.

WARNING Do not use a cleaner that contains alcohol or acetone. You might damage the screen.

Protecting your display from theft

The slot at the base of the display in the back is for connecting a security lock. It lets you attach a narrow, flexible cable that you can use to secure your display (and the rest of your computer system) to prevent theft. Security locks are available from an Apple-authorized dealer or service provider.

Troubleshooting

Solutions to common problems related to your display are described here. Problems related to the computer itself are covered in the manuals that came with your computer.

WARNING Never remove the cover from the display or you may come in contact with hazardous voltage levels capable of causing serious injury and possibly death.

WARNING If you have a problem with your display and nothing presented in this manual solves it, consult the service and support information that came with your display for instructions on how to contact an Apple-authorized service provider or Apple for assistance. If you attempt to repair the display yourself, any damage you may cause to the display will not be covered by the limited warranty on your display. Contact an Apple-authorized dealer or service provider for additional information about this or any other warranty question.

The display's power indicator light doesn't come on.

- Make sure the computer is turned on.

The display's indicator light won't come on unless your computer is on.

- Make sure an energy saver program isn't active on the computer.

The display's indicator light won't come on when an energy saver program is on. Also, it may take awhile to wake up your computer after you use an energy saver.

- Make sure that the power cord is plugged in properly.

If the display power cord is plugged into your computer, make sure your computer is on and the cord is firmly plugged in.

If the display power cord is plugged into a wall outlet, make sure the cord is firmly plugged in. Check to see whether power to the outlet has been interrupted. You can test the outlet by plugging in something that you know works—like a desk lamp or radio. If the test appliance works, but the display doesn't, contact an Apple-authorized dealer or service provider.

- Make sure the display cable is plugged into your computer properly.

If you have a video card installed in your computer, the display cable should be plugged into the port for the video card.

If you do not have a video card installed in your computer, the display cable should be plugged into the display port on the back of your computer.

- Make sure the thumbscrews on the display cable are tightened securely.

No image appears on the screen and the display's power indicator light is on.

- Make sure the display cable is connected to the correct port on the back of the computer.

If you have a video card installed in your computer, the display cable should be plugged into the port for the video card.

If you do not have a video card installed in your computer, the display cable should be plugged into the display port on the back of your computer.

- Make sure the thumbscrews on the display cable are tightened securely.
- Make sure the contrast (●) and brightness (☼) controls are set correctly. The contrast and brightness controls are on the front of your display.

The screen is dark or appears dim.

- Make sure that your computer and display are turned on.
- Make sure that the power cord and the display cable are securely connected at both ends.
- Increase the contrast and brightness of the screen image. The contrast (●) and brightness (☼) controls are on the front of your display.
- A screen saver that darkens your screen may be activated. Move the mouse or press any key on the keyboard to reactivate the display.

The screen flickers.

- Make sure the display cable is connected firmly to the correct port on the back of the computer.

If you have a video card installed in your computer, the display cable should be plugged into the port for the video card.

If you do not have a video card installed in your computer, the display cable should be plugged into the display port on the back of your computer.

- The flickering could be caused by interference from a nearby power line or electrical equipment—for example, a radio, a microwave oven, or another computer. Try relocating nearby electrical equipment, or moving your computer and display.
- If you are using a video card that has a very low refresh rate (at or below 60 Hz), the display may flicker. You may be able to change the refresh rate for the card. See the manual that came with your video card for more information.

There are one or two very thin gray lines across the screen, one near the top and the other near the bottom.

- This is a normal characteristic of the Trinitron color picture tube design. The lines do not appear in any documents you print.

Over time, you experience eyestrain.

- Adjust the screen contrast. In a bright room, contrast is usually best set at maximum; in a dim room, lower contrast is usually more comfortable. The contrast (●) controls are on the front of your display. Also, be sure to take occasional breaks to focus your eyes on a distant object.

- Adjust the color temperature of the screen image. For most applications, a white point of 9300 K is best. See “Adjusting Color Temperature and Overscan” in Chapter 9.

The screen image is off center.

- Adjust the center of the screen image. See “Adjusting Screen Geometry” in Chapter 9.

The screen image is too large or too small.

- Adjust the horizontal or vertical size of the screen image. See “Adjusting Screen Geometry” in Chapter 9.
- Try changing to another resolution. To change resolutions, see the manual that came with your computer or video card.

The screen image is tilted slightly to the left or right.

- Adjust the rotation of the screen image. See “Adjusting Screen Geometry” in Chapter 9.



Images or text on your screen appear fuzzy or blurred.

- Adjust the horizontal or vertical convergence of the screen image. See “Adjusting Convergence” in Chapter 9.



The colors on your screen appear too blue, too yellow, or too red.

- Adjust the color temperature of the screen image. See “Adjusting Color Temperature and Overscan” in Chapter 9.

You hear no sound on your AppleVision 1710Av speakers or headphones.

- Make sure the headphones are securely connected to the display’s sound output port (marked by .
- Increase the volume. Locate the volume controls (marked by ) on the front of your display and press the  button.

The internal microphone doesn’t record.

- Turn on the microphone, by pressing the microphone button (marked by ) on the front of your display. When the microphone is on, the microphone indicator light is on.
- Make sure the connector marked by  on the sound cable is connected to the sound input port on your computer.

An external microphone connected to the sound input port (marked by 🎧) on the display doesn't record quality sound.

- Some external microphones don't work well with the AppleVision 1710AV Display. Use the display's built-in microphone, or plug the external microphone directly into the sound input port on the back of your computer.



Appendixes

Appendix A Working With ColorSync

Appendix B Technical Information

III
part





Appendix A Working With ColorSync



The Macintosh does a lot of work to make sure that the colors you see on your display closely match the colors you get on your printers, scanners, and other devices. The software that does this work is called ColorSync. This appendix explains how ColorSync works and how you can benefit from using it.

The problem that ColorSync solves

Providing consistent color with desktop computers is a technical challenge. Reproducing colors consistently from device to device is difficult because colored light on your display is very different from printed ink. Different color devices use different methods for representing color information and produce different ranges of colors.

Displays (and most scanners) produce colors by mixing red, green, and blue light—called RGB color. Most printers produce colors by mixing cyan (a shade of blue), magenta (a bright pink), yellow, and black ink—called CMYK color. Since displays and printers have different color capabilities, they cannot reproduce each other's colors exactly.

In addition, no two displays or printers produce exactly the same colors. (You can see an example of the differences among monitors at a consumer electronics store, in the section that sells television sets.)

About ColorSync

ColorSync is a system extension that provides color-conversion capabilities and improves color consistency. ColorSync “translates” the colors used on one device so that they match the colors displayed or printed on another device.

ColorSync color conversion is a central part of Macintosh computing—ensuring that application programs, displays, printers, scanners, and digital cameras use the same scheme for color conversion. This means you can scan an image, open it on your display, and print it—with visually matching colors every step of the way.

How ColorSync works

ColorSync does not convert colors directly from one device to another. Instead, ColorSync takes information about each device’s color capabilities and compares it to an independent color standard. In this way, it converts the colors produced on one device to closely matching colors that can be reproduced on another device.

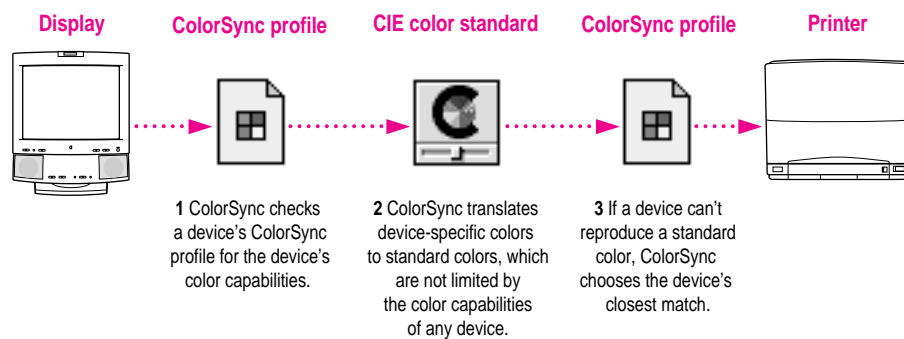

ColorSync defines the colors a display, printer, scanner, or digital camera can reproduce in a ColorSync profile. ColorSync profiles are compatible with the profile specifications of the International Color Consortium (ICC).

Next, ColorSync converts device-specific colors into standard colors. The CIE color standard describes colors in terms of how they are perceived by the human eye under standardized lighting conditions. (CIE stands for the Commission International de l’Eclairage, the International Commission on Illumination, which founded the standard.)

To maintain consistency, ColorSync previews a device’s color capabilities (in the ColorSync profile) and—where necessary—converts standard colors to closely matching colors that the device can reproduce. For example, your display may be able to display a vivid red, but your printer inks may not be able to produce that color. ColorSync determines the “next best” color for your printer to use.

Using ColorSync

The default ColorSync profile for the AppleVision 1710AV Display is automatically installed as part of the AppleVision software. This profile is named *AppleVision 1710–9300* and is located in the ColorSync Profiles folder.

To meet your specific project requirements, you can use the AppleVision Setup control panel to create a custom ColorSync Profile for your display. For more information, see Chapter 4.

To use a new ColorSync profile:

- 1 Make sure the profile you want to use is located in the ColorSync Profiles folder.**

This folder is located in the Preferences folder in your System Folder. When you export a ColorSync profile from the AppleVision Setup control panel, this folder is selected automatically.

- 2 Choose Control Panels from the Apple () menu and open the ColorSync System Profile control panel.**

The ColorSync System Profile control panel appears.

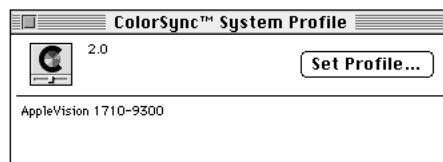

3 Click Set Profile.

A dialog box appears with a list of ColorSync profiles.

4 Click the profile you want to use.

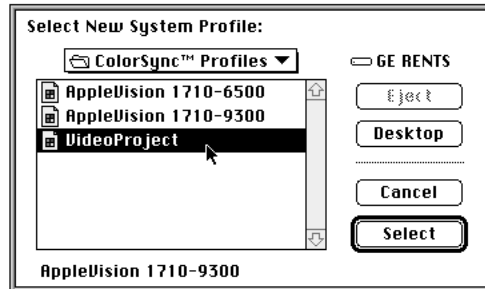

5 Click Select.

ColorSync automatically references the profile you selected and uses the information to match colors across devices.

6 Close the ColorSync System Profile control panel.



Display cable specifications

- 15-pin miniature D-type connector

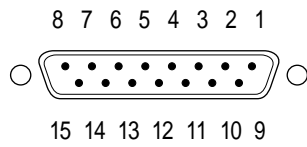

Pin	Output signal
1	Red video ground
2	Red video
3	Not used
4	ID 1/DDC RTN
5	Green video
6	Green video ground
7	ID 2/DDC SCL
8	Not used
9	Blue video
10	ID 3/DDC SDA
11	V Sync return
12	V Sync
13	Blue video ground
14	H Sync return
15	H Sync
Shell	Shield ground

Temperature

Celsius (C) and Fahrenheit (F)

- Operating 10° to 40° C (50° to 104° F)
- Storage 0° to 60° C (32° to 140° F)
- Shipping –40° to 60° C (–4° to 140° F)

Humidity (noncondensing)

- Operating 10% to 80%
- Storage 5% to 90%
- Shipping 5% to 95%

Altitude

- Operating 0 to 10,000 feet (ft.)
0 to 3048 meters (m)
- Shipping 0 to 35,000 ft.
0 to 10,670 m



Speakers

- Stereo, with ported (bass reflex) chamber design
- Maximum loudness: 92 dB SPL at 1 kHz at 0.5 meters
- Frequency response: 70 Hz to 20 kHz \pm 6 dB

Headphone jack

- Output level: 1.75 V_{pp} into 4 Ω load and 2 V_{pp} into 10k Ω load

Input electrical requirements

- Voltage 100-240 V
- Frequency 50-60 Hz
- Power 130 W maximum

Weight

- Approximately 60 pounds (27 kilograms)

Dimensions

- Height 507 millimeters (mm) \pm 3 mm
- Width 405 mm \pm 3 mm
- Depth 452 mm \pm 3 mm
(not including cables)

Interfaces

- Apple Desktop Bus (ADB): One input port and two ADB pass-through output ports
- Microphone: One input port and one microphone port
- Headphone/Speaker: One output port and two speaker ports

Color compatibility

- Works with ColorSync 2.0 or higher. ColorSync profiles are compatible with the profile specifications of the International Color Consortium (ICC).

User controls

- Power-on button
- Automatic degauss at power-up; manual degauss by turning power switch off, then on (capable of full degauss after monitor is turned off for 20 minutes or more)
- Control buttons: Contrast, brightness, bass, treble, microphone on, volume, mute, and three buttons for on-screen controls
- Additional picture and sound controls available using the AppleVision Setup control panel (Macintosh users) or on-screen controls (IBM PC-compatible users)

Active video image area

- Adjusted at the factory for the following standard modes:

Mode	Resolution	Vertical refresh rate (hertz)	Horizontal scan rate (kilohertz)
VGA	640 x 480	60	31.5
Macintosh	640 x 480	66.67	34.97
VESA	800 x 600	60.31	37.9
VESA	800 x 600	75	46.9
Macintosh	832 x 624	74.55	49.7
Macintosh	1024 x 768	74.93	60.24
VESA	1024 x 768	60	48.4
VESA	1280 x 1024	60	64.3
VESA	1280 x 1024	75.03	79.98

Audio input signals

- Accepts audio signal of up to 4 Vpp (line level–low sensitivity) or as low as 20 mVpp (microphone level–high sensitivity) without clipping the signal, depending upon the level and sensitivity setting

Microphone

- Directional, optimized for use in speech recognition and other voice-related application programs



Appendix B Technical Information

• • • • •

Picture tube

- 17-inch (16.1-inch diagonal viewable image size) Trinitron CRT
- Multiple scan
- Vertical Refresh: 50 Hz to 120 Hz
- Horizontal Scan: 30 kHz to 80 kHz

Screen

- Antistatic, antiglare surface treatment
- 0.26 millimeter (mm) stripe pitch

Input signals

- Red, green, and blue signals; separate sync

Power-saving feature

- Conforms to the Energy Star program of the United States Environmental Protection Agency
- Power-saving feature compatible with Video Electronics Standards Association (VESA) Display Power Management Standard (DPMS)

If you can't find what you're looking for in this index, look in Macintosh Guide—available in the Guide (🔍) menu on your computer.



Index

🔍 icon xiii

A

active video image information, standard modes 146

adapters

high-density for Macintosh computers 10

for IBM PC-compatible computers 118, 121–122

ADB (Apple Desktop Bus) connector moving (PC users) 122

plugging in (Macintosh users) 9–10

ADB (Apple Desktop Bus) port for keyboard and mouse 11–12
location 5
in use 10

adjusting screen image. *See* screen image

adjusting sound. *See* sound

alert sound

controlling 75–77

installing 80

problems 109

removing 81

setting 79–80

ambient light

about 50

correcting in AppleVision Setup control panel 43

creating a setting 51–53

defined 42

deleting settings 54–55

problems 108

using an existing setting 53–54

ambient light tool 4, 51–53

Apple Desktop Bus (ADB) port. *See* ADB (Apple Desktop Bus)

Apple PlainTalk microphone connector 12

AppleVision 1710AV Display, viewable image size 1, 145

AppleVision Setup control panel 78
adjusting contrast and brightness 27–28

adjusting height and width 29–30

adjusting screen image 24–26

location 23

opening automatically 26

using more than one display 27

“AppleVision Setup failed to load” message 106

- AppleVision Setup icon 24–25
- AppleVision software, installing 15–16
- AppleVision Software disk 15, 124
- AppleVision speakers 5
- audio CD, playing on display speakers 88–90
- audio CD player, connecting
 - Macintosh users 12–13, 88–89
 - PC users 123
- audio input signals 146
- Audio Out port, on VCR 86
- automatic routing path 74

B

- bass sound (Macintosh users)
 - adjusting on display 77–79
 - controls 5, 65–66
- bass sound (PC users), controls 126
- blank screen
 - Macintosh users 108
 - PC users 135
- brightness (Macintosh users)
 - adjusting in AppleVision Setup control panel 25, 27–28
 - adjusting with control buttons 5, 23–24
 - problems 104
- brightness (PC users)
 - adjusting with control buttons 126
 - problems 136
- Built-in icon 68, 72
- built-in sound equipment, connecting 11
- built-in volume control 75–77
- buttons (Macintosh users)
 - control 5
 - disabling 24, 58
- buttons (PC users), control 126–127

C

- cables (Macintosh users)
 - for connecting video equipment 85
 - display 5
 - sound 11–13
- cables (PC users)
 - display 118, 121–122
 - sound 5
- cable specifications 149
- case, cleaning
 - Macintosh users 1–3, 101–102
 - PC users 115–116
- cassette player, connecting
 - Macintosh users 12–13
 - PC users 123
- CD player. *See* audio CD player
- CD-ROM sound input port 68–69
- centering screen image
 - Macintosh users 31–32
 - PC users 128–129
- characterizing color 41–42
- CIE color standard
 - ColorSync 142
 - using to create a white point 47–50
- cleaners, damage from 102, 133
- cleaning instructions
 - Macintosh users 1–3, 101–102
 - PC users 115–116, 133–134
- climate, operating 148
- CMYK colors, printer mix 141
- color compatibility, technical information 147
- color depth, changing in Control Strip 91, 94–95
- color display. *See* display
- color-matching systems. *See* colors; ColorSync profiles; ColorSync software
- color monitor. *See* display

- colors (Macintosh users)
 - adjusting convergence 35–37
 - adjusting in AppleVision Setup control panel 25
 - changing depth 91, 94–95
 - characterizing 41–42
 - CIE industry standards 47
 - creating an ambient light setting 51–53
 - creating a white point 45–50
 - deleting settings 61
 - fine-tuning 42–43
 - importing and exporting ColorSync profiles 61–63
 - maintaining with ColorSync 141–144
 - opening the Color window 42–43
 - problems 107–108
 - saving settings 43, 58–60
 - setting a white point 44–45
 - using ColorSync 141–144
 - using existing settings 60–61
 - using factory settings 59
- colors (PC users)
 - adjusting color temperature 130
 - adjusting convergence 131
 - adjusting overscan 129–130
 - problems 137
 - setting mix 130
- ColorSync profiles
 - default 143
 - importing and exporting 43, 61–63
 - for matching colors 41–42
 - problems 108
 - selecting 143–144
- ColorSync software
 - operation 142–143
 - solving color problems 141–142
 - using 143–144
- color temperature (PC users),
 - adjusting 130. *See also* colors (Macintosh Users)
- Color window, opening in AppleVision Setup control panel 42
- communications regulation information xi-xii
- composite video format 83
- computer displays, gamma value used 55
- connecting display (Macintosh users)
 - display cable 9–10
 - keyboard and mouse 11–12
 - power cord 8–9
 - precautions 8
 - sound cable 11
- connecting display (PC users) 121
- connecting external sound equipment (Macintosh users) 5, 12–13
- connecting sound input equipment (PC users) 123
- connecting sound output equipment (PC users) 123
- connecting video equipment to Macintosh 84–86
- conserving energy 20–22
- contrast (Macintosh users)
 - adjusting in AppleVision Setup control panel 25, 27–28
 - problems 104, 106
 - using control buttons 5, 23–24
- contrast (PC users)
 - problems 136
 - using control buttons 126
- control panels vs. Control Strip 92
- controls (Macintosh users)
 - diagram of 5
 - headphone volume 78–79
 - sound 65
 - speaker volume 78–79
 - volume 74–77
- controls (PC users)
 - diagram of 126
 - on-screen 128
 - using to open on-screen controls 127

- Control Strip
 - changing common settings 91
 - closing 92
 - customizing 98–99
 - defining hot key 96–98
 - help 91
 - hiding 95–96
 - moving 95
 - opening 92
 - problems 108
 - resizing 93
 - using to change color depth 94–95
 - using to change resolution 20, 93–94
 - vs. control panels 92
- convergence
 - Macintosh users 35–37
 - PC users 131
- custom white point
 - deleting setting 54–55
 - recalibrating 50, 57–58
 - using CIE standards 47–50
 - using Kelvin temperature or color standards 43, 45–47
- Custom White Point dialog box 46, 49

D

- default screen settings
 - Macintosh users 29–30
 - PC users 127–129
- disabling buttons 24, 58
- disconnecting power
 - Macintosh users 2
 - PC users 115
- Display button 27
- display cable 5
 - connecting to IBM PC-compatible computer 121
 - connecting to Macintosh computer 9–10
 - provided 4
 - specifications 149
 - unobstructed 6
- display colors. *See* colors

- display (Macintosh users). *See also* screen image adjustment; setup
 - age of 42
 - changing screen resolution 18–29
 - cleaning 101–102
 - connecting to computer 8–12
 - connectors 5
 - control buttons 5
 - description 1
 - diagrams 4–5
 - electrical hazards 2–3, 102
 - installing software 15–16
 - ports 9
 - positioning for comfort 6–7
 - problems starting 103–104
 - recalibrating 57–58
 - screen image problems 107–108
 - sound problems 109–111
 - turning on 14
 - using more than one 7
 - using speakers 88–90
 - “waking up” 22
- display (PC users). *See also* screen image adjustment; setup
 - cleaning 115–116, 133–134
 - compatibility 117
 - connecting to computer 120–123
 - connectors 118
 - control buttons 126–127
 - diagram 118
 - electrical hazards 120
 - ports and connectors 121–122
 - positioning for comfort 120
 - problems starting 135–136
 - screen image problems 137
 - sound problems 137–138
 - turning on 124
- display port icon 9
- display power cord (Macintosh users)
 - connecting 8–9
 - provided 4–5
- display power cord (PC users)
 - connecting 121
 - provided 118
- display technical information 145–149
- Display window 27–28

E

- electricity
 - hazards 2–3, 116, 134
 - requirements 147
- electromagnetic emissions 3
- energy, conserving 20–22
- Energy Saver
 - icon 21
 - indicator 14
 - problems 105
 - and screen saver programs 22
 - turning on or off 20–21
 - working with 22
- equipment, care and cleaning
 - Macintosh users 101–102
 - PC users 115–116
- ergonomics 6–7, 120
- error messages. *See* messages
- extended stereo miniplug connector 12
- external sound equipment, connecting to
 - Macintosh computer 5, 12–13
- eyestrain 106

F

- factory settings, resetting 29–38
- 15-pin adapter 10
- 15-pin miniature D-type connector 149
- fine-tuning display color
 - about color 41–42
 - adjusting the gamma curve 55–56
 - creating a custom white point 45–50
 - deleting a custom white point or
 - ambient light setting 54–55
 - importing and exporting ColorSync profiles 61–63
 - opening the Color window 42–43
 - recalibrating 57–58
 - setting ambient light 50–54
 - setting a white point 44–45
 - using color settings 58–60
 - using control panels 42–43
- flickering screen
 - Macintosh users 105
 - PC users 136

G

- gain setting 87–88, 90
- gamma curve (Macintosh users) 42–43, 55–58
 - adjusting 55–56
- gamma values 42, 55
- Geometry button 29
- grounding plug 8, 120
- Guide menu xiii

H

- headphones, output level for jack 147
- headphones (Macintosh users)
 - adjusting volume 25
 - plugging in 5, 13
 - problems 109
- headphones (PC users)
 - plugging in 123
 - problems 137
- Headphone Volume control 78
- height, adjusting screen image
 - Macintosh users 29–30
 - PC users 127–128
- help
 - from Macintosh Guide xiii
 - for Control Strip module
 - descriptions 91
- high-density port 10, 69
- horizontal shift, adjusting screen image 127–129
- hot key, defining 96–98

I, J

- IBM PC-compatible computers, requirements 117
- icons
 - AppleVision Setup 24–25
 - Built-in 68, 72
 - display port 9
 - Energy Saver 21
 - Installer 15
 - Monitors 18
 - Sound 67
 - sound input port 11, 12
 - sound output port 12
- image. *See* screen image adjustment
- indicator light
 - Macintosh users 14, 103–104, 124
 - PC users 135
- input electrical requirements 147
- input port. *See* sound input ports
- input signals 145
- Installer icon and program 15
- installing display software 15–16
- interfaces, technical information 147
- interference, radio and television xi
- internal speakers, muting 77

K

- Kelvin temperature scale
 - Macintosh users 44–46
 - PC users 130
- keyboard, connecting 11–12

L

- laserdisc players, video format 83
- lines, screen 105, 108
- locking out preferences 24, 58
- Loop Through Off routing path 74

M, N

- Macintosh computer
 - connecting to video equipment 84–86
 - desktop not displayed 17
 - system software required 15
- Macintosh Guide
 - getting help from xiii
 - instructions for adjusting screen image 25
- menu font, changing 98–99
- menus
 - Guide xiii
 - hidden by overscan 38
- messages
 - “AppleVision Setup failed to load” 1–6
 - “This software only works with an AppleVision display” 106
- microphones, technical information 146
- microphones (Macintosh users)
 - built-in 5, 11
 - connecting external 12–13
 - control buttons 5, 65
 - indicator light 5
 - problems 110
 - sound input source for display 70–71
 - using to record an alert sound 81–82
 - voice-quality 74
- microphones (PC users)
 - built-in 123
 - connecting external 123
 - control button 126
 - problems 137–138
- miniplug adapters 12
- modules in Control Strip
 - controlling visibility 91
 - help with 91
 - rearranging 98
- monitor. *See* display
- Monitor Controls
 - Macintosh users 17, 26
 - PC users 127–131

Monitors control panel (Macintosh users)
 display doesn't appear 17, 26, 106
 uses of 18–20
Monitors icon 18
mouse, connecting 11–12
multimedia application programs, support
 for 1
music CD. *See* audio CD
mute button
 Macintosh users 5, 65
 PC users 126
muting, problems 110–111

O

overscan, turning on and off
 Macintosh users 37–38
 PC users 129

P, Q

PC adapter 118, 121–122
picture. *See* screen image adjustment
pictures in Control Strip. *See* Control
 Strip
picture tube, technical information 145
Pincushion button, adjusting screen
 image 127–128
Playthrough option 69
ports. *See* sound input ports; S-video
 formats
power button
 Macintosh users 5, 14, 23
 PC users 124
power cord. *See* display power cord
power indicator light
 Macintosh users 5
 PC users 124

power jumper cord, connecting 9
power plug, disconnecting
 Macintosh users 2, 101–102
 PC users 115–116
power-saving feature, technical
 information 145
precautions for safety and cleaning
 Macintosh users 1–3, 8
 PC users 115–116

R

“rainbow” effect
 Macintosh users 35–37
 PC users 131
RCA-type plug adapters 84
recalibrating display (Macintosh
 users) 43
 automatically 57–58
 for color accuracy 57
recording sounds (Macintosh users)
 alert 81–82
 problems 110
 and a video 82–88
recording sounds (PC users), problems
 137–138
repair service 103, 134
resolution (Macintosh users)
 adjusting screen image in control
 panel 27
 changing in control panel 18–20
 changing in Control Strip 91, 93–94
resolution (PC users), supported 117
restarting the Macintosh 16
RGB color 141
rotation, adjusting screen image 127–129
routing display sound 73–74

S

- safety instructions
 - Macintosh users 1–3, 8
 - PC users 115–116
- scanners, gamma value 55
- scan rate 130
- screen geometry settings (Macintosh users)
 - adjusting 25, 29–30
 - recalling default settings 29–30
- screen geometry settings (PC users), adjusting 126–127
- screen image adjustment (Macintosh users) 31–32
 - contrast and brightness 27–28, 104
 - controls 23, 104
 - convergence 35–37
 - height and width 29–30
 - matching gamma curves 55–56
 - opening and closing AppleVision Setup control panel 24–27
 - problems 107
 - recalibrating 57–58
 - rotation 34–35
 - shape 32–33
 - turning overscan on and off 37–38
- screen image adjustment (PC users)
 - color temperature and overscan 129–130
 - control buttons 125–126
 - convergence 131
 - default 126, 129
 - on-screen controls 127
 - problems 137
 - screen geometry 128–129
 - sound problems 137–138
- screen problems
 - Macintosh users 103–108
 - PC users 134–137
- screen resolution. *See* resolution
- screen saver programs 22, 104
- screen technical information 145
- security lock (Macintosh users) 102
- service providers 103, 134
- settings, factory
 - Macintosh users 29–38
 - PC users 127–129
- setup (Macintosh users)
 - assessing need for video card 7
 - choosing location for display 6
 - components provided 4
 - connecting external sound equipment 12–13
 - connecting the display 8–12
 - diagram of display 5
 - installing display software 15–16
 - for more than one display 7
 - positioning display 6
 - safety and cleaning instructions 1–3
 - turning on display 14
- setup (PC users)
 - choosing location for display 119
 - connecting external sound equipment 123
 - connecting the display 120–123
 - diagram of display 118
 - positioning display 119–120
 - safety and cleaning instructions 115–116
- software, installing AppleVision 15–16
- sound (Macintosh users)
 - adjusting 74–79
 - adjusting volume, treble, and bass on display 77–79
 - alert volume control 75
 - built-in volume control 75
 - computer options 73
 - connecting output equipment 12–13
 - controls at a glance 5, 65–66
 - installing alert sounds 80
 - output port 5, 12, 71–73
 - playing an audio CD on display speakers 88–90
 - problems 109–111
 - recording alert sounds 81–82
 - recording sound and video 82–88
 - routing display sound 73–74
 - selecting a sound input source for the display 66, 70–71

- selecting a sound input source for the computer 67–71
 - selecting a sound output device for the display 66, 72–73
 - selecting output equipment 71–73
 - volume control on Alert Sounds panel 80
 - sound (PC users)
 - controls 125–126
 - problems 137–138
 - Sound button 67
 - sound cable (Macintosh users)
 - connecting built-in equipment 11
 - connecting external equipment 12–13
 - diagram 5
 - plugging in 11
 - provided 4
 - sound cable (PC users)
 - connecting 122–123
 - connecting built-in equipment 122–123
 - diagram 118
 - Sound control panel
 - doesn't appear 67, 72, 75, 80
 - for setting alert sounds 79
 - Sound icon 67
 - sound input equipment, connecting
 - Macintosh users 12–13
 - PC users 123
 - sound input ports (Macintosh users) 5, 11–12, 86
 - connecting VCR to display 86
 - selecting on computer 67–70
 - speakers
 - adjusting volume in AppleVision Setup control panel 25
 - muting internal 77
 - playing audio CD on display 88–90
 - problems
 - Macintosh users 109
 - PC users 137
 - technical information 147
 - specifications, display 145–149
 - starting the Macintosh 16
 - stereo miniplug connector 12
 - support and service 103, 134
 - S-video formats
 - connectors 84
 - input and output ports 83
 - ports in video connections 86
 - System 7.5 system software, help for xiii
 - system software (Macintosh users), required 15
- T**
- technical information 145–149
 - television, composite format 83
 - temperature settings for colors (PC users) 129–130. *See also* colors (Macintosh users)
 - theft, preventing 102, 134
 - “This software only works with an AppleVision display” message 106
 - three-wire grounding plug 8
 - timing ranges, compatibility with 117
 - treble sound
 - adjusting on display 77–79
 - controls 5, 65–66
 - troubleshooting (Macintosh users)
 - contrast and brightness 104
 - Energy Saver 105
 - eyestrain 106
 - flickering screen 105
 - gray lines 105
 - Monitors control panel 106
 - problems starting up 103–104
 - troubleshooting (PC users)
 - contrast and brightness 136
 - eyestrain 136–137
 - flickering screen 136
 - gray lines 136
 - problems starting up 135–136
 - screen image problems 137
 - sound problems 137–138
 - tuning the display. *See* colors
 - turning power on or off 5, 14, 23

U

user controls, technical information 146

V

VCR

- connecting to Macintosh 84–86
- video format 83

ventilation of display

- Macintosh users 2
- PC users 116, 133

vertical shift, adjusting screen image 127–128

VESA (Video Electronics Standards Association) standard

- modes 117

VGA (Video Graphics Array)

- compatibility 117

video camera, video format 83

video capability (Macintosh users) 7

- about equipment 83–84
- connecting equipment to computer 84–86

- recording with sound 82–88

- using equipment with display 84–88

video cards (Macintosh users) 7

- connecting 9

- installing 9

video cards (PC users)

- connecting 122

- installing 120

- requirements 117

video-editing equipment, gamma

- value 55

video formats supported 83

Video Out port (Macintosh users), on

- VCR 86

voice-quality microphone routing

- path 74

volume (Macintosh users)

- adjusting on display 77–79

- checking volume controls on computer 74–77

- controls 5, 65

- speaker and headphone 25

volume (PC users), controls 126

W, X, Y, Z

“waking up” the display 22

warranty 103, 134

washed-out colors 42

wavy lines 108

weight of display 6, 147

white points (Macintosh users)

- about 44

- creating custom 42, 43

- creating custom using Kelvin temperature 45–47

- creating using a CIE color space 47–50

- predefined 45

- recalibrating 45, 50

- selecting standard 43

- using existing 44–45

width, adjusting

- Macintosh users 29–30

- PC users 127–128

The Apple Publishing System

This Apple manual was written, edited, and produced on a desktop publishing system using Apple Macintosh computers and QuarkXPress. Technical illustrations were drawn in Adobe™ Illustrator; screen shots were created and modified with system software, ExposurePro, Aldus SuperPaint, and Adobe Photoshop. Proof pages were created on Apple LaserWriter printers and on QMS and Tektronix color printers. Final pages were output directly to separated film on a PostScript™-driven imagesetter.

Text type is Times®, display type is Helvetica® Narrow, and cover type is Apple Garamond, Apple's corporate font. Ornaments are custom symbols designed for Apple Computer.

PostScript, the LaserWriter page-description language, was developed by Adobe Systems Incorporated.